



Supply Chain Traceability

Small Stock

This document contains all existing information included in the Red Meat Supply Chain Committee; Small Stock Supply Chain Model available online at rmscc.org. The contents of this document are specific to the information flows as they occur throughout all aspects of the small stock supply chain including Critical Tracking Events, Key Data Elements, Physical Inputs and Outputs as well as information relating to regulatory bodies and programs as well as traceability scenarios.

Prepared by: Paige Mazoudier, Ethan Ward, Fiona Gojan and Des Bowler

Version: 0.4

Issue date: 19 August 2022

Contents

1	Document Overview	4
1.1	Document Version Control	4
2	Introduction to the RMSCC.....	5
3	The Red Meat Supply Chain.....	6
4	Traceability in the Red Meat Supply Chain.....	7
4.1	What is traceability and its purpose?	7
4.2	What does traceability in the global small stock supply chain look like?.....	7
4.3	What are Critical Tracking Events?	8
4.4	What are Key Data Elements?	9
5	The Small Stock Supply Chain Model.....	11
5.1	Introduction.....	11
5.2	Supply Chain Sectors	12
5.2.1	Exporting Country - Livestock	12
5.2.1.1	Breeding.....	12
5.2.1.2	Finishing/Backgrounding	22
5.2.1.3	Saleyard	29
5.2.2	Exporting Country - Processing.....	40
5.2.2.1	Lairage.....	40
5.2.2.2	Slaughter	50
5.2.2.3	Carcase chiller	61
5.2.2.4	Boning room	71
5.2.2.5	Offal room.....	81
5.2.2.6	Render	91
5.2.2.7	Fleece.....	109
5.2.2.8	Cold store (carcase)	118
5.2.2.9	Cold store (cartons)	129
5.2.3	Exporting Country - National distribution	143
5.2.3.1	Independent boning room.....	143
5.2.3.2	Value-added.....	159
5.2.3.3	Third party cold store	174
5.2.3.4	Supermarket	191
5.2.3.5	Butcher	202
5.2.3.6	Food services	213
5.2.4	Exporting Country - Cross-sector.....	224
5.2.4.1	Livestock transport	224
5.2.4.2	Refrigerated transport.....	234

5.2.4.3	Bulk transport	247
5.2.5	International Trade	259
5.2.5.1	Live export	259
5.2.5.2	Non packer exporter	275
5.2.5.3	Export.....	288
5.2.6	Importing Country - National distribution.....	304
5.2.6.1	Import finishing/backgrounding.....	304
5.2.6.2	Import inspection facility.....	313
5.2.6.3	Import livestock processing	325
5.2.6.4	Import value-added	325
5.2.6.5	Import third party cold store	339
5.2.6.6	Import supermarket	354
5.2.6.7	Import butcher	363
5.2.6.8	Import Food Services	372
5.2.7	Importing Country - Cross-sector	380
5.2.7.1	Import livestock transport.....	380
5.2.7.2	Import refrigerated transport.....	386
5.2.7.3	Import bulk transport	397
6	Glossary	406
7	Reference List	409

1 Document Overview

This document is a printable version of the interactive Small Stock Supply Chain Model which can be found at <https://www.rmscc.org/supplychain.asp>. Supply Chain Traceability – Small Stock provides detailed information on the traceability in both the Australian domestic and export sectors of the supply chain including:

- An overview Red Meat Supply Chain Committee (RMSCC)
- An overview of the Australian red meat industry
- An introduction to supply chain traceability, Critical Tracking Events (CTEs) and Key Data Elements (KDEs)
- Descriptions of each stage of the small stock supply chain, as well as visual diagrams, details of the physical and information inputs and outputs associated with each stage, key regulatory and industry programs, and detailed examples of supply chain traceability at each stage.

For more information regarding the RMSCC and related traceability projects, please visit <https://www.rmscc.org/>.

1.1 Document Version Control

Version	Date	Summary of Changes	Contributors
0.1	24/08/2021	<ul style="list-style-type: none"> • Transcription of RMSCC webpages into document (sections 2,3,5.2,6). • Writing of sections 2, 3, 4, 5.1. • Approval of final draft layout. 	Paige Mazoudier Des Bowler
0.2	26/08/2021	<ul style="list-style-type: none"> • Editing sections 2, 3, 5.1. • Updated RMSCC web address. 	Ethan Ward
0.3	27/05/2022	<ul style="list-style-type: none"> • Update for DFD 	Fiona Gojan
1.4	08/8/2022	<ul style="list-style-type: none"> • Update for DFD 	Fiona Gojan

2 Introduction to the RMSCC

The Red Meat Supply Chain Committee (RMSCC) is an industry-government steering committee focused on improving the information systems and processes that link or supply chain together.

The committees’ activities include the codification of existing systems employed by business across the supply chain that identify and capture data. This area of focus is referred to as **'Supply Chain Information Standards'**.

The goal of these activities is to provide an open, consist of language that each sector of the industry can use to communicate with each other.

The role of the RMSCC is to:

- Provide a path for reporting to the AMILSC on industry program and project activities related to information standards along the red meat supply chain.
- Provide a path for communication back to government and industry bodies on relevant supply chain information standards, projects, programs, and related activities.
- Provide harmonisation, coordination, and governance support to programs and projects on a voluntary basis. Support is provided only to those programs and projects that request them and only where the programs and projects activities relate to information standards along the red meat supply chain.

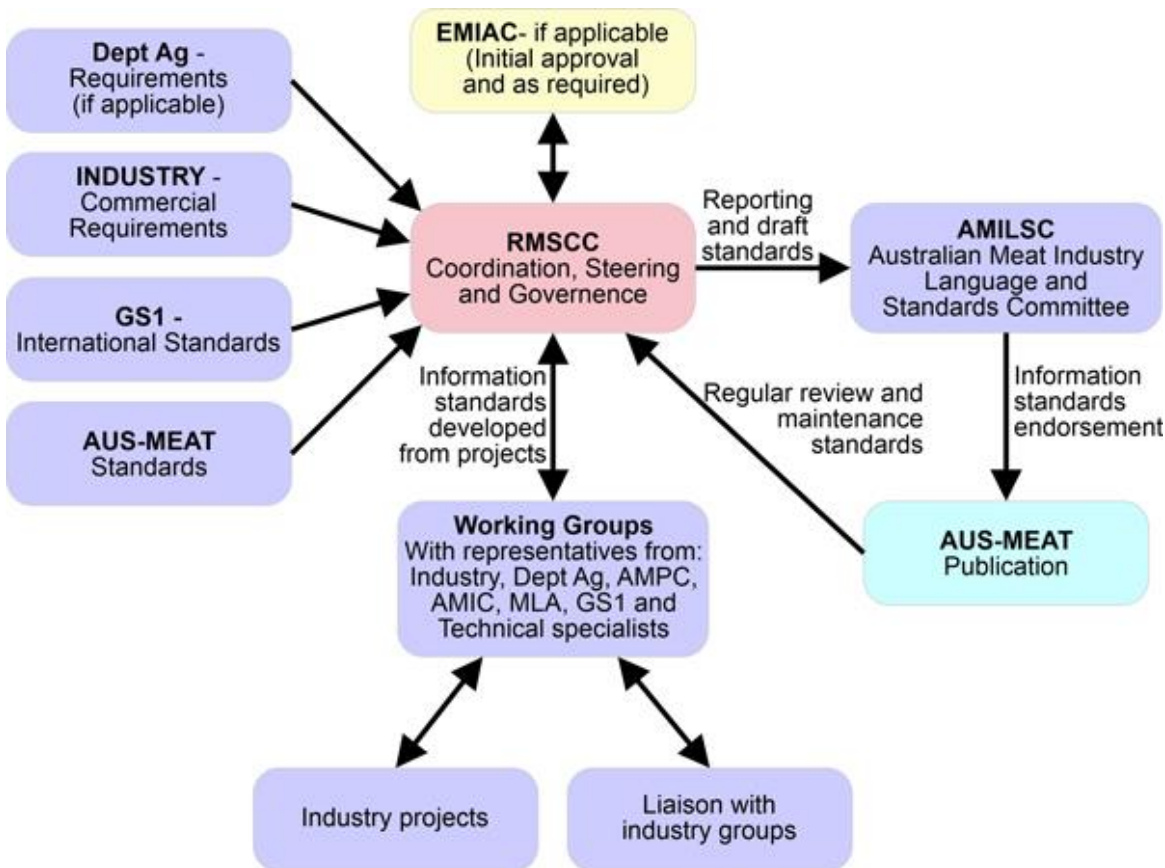

Figure 1. Red meat supply chain structure with respect to the publishing of industry standards.

3 The Red Meat Supply Chain

Supply Chain traceability and integrity have become the leading topics that underpin consumers, trading partners, and governments trust in Australia's 'clean and green' status.

With the release of the National Traceability Framework in 2019, the Australian Government have acknowledged that improvements to Australia's product integrity and traceability cannot solely come from government regulation.

There have been a growing number of supply chain standards specific to the red meat industry which have been imposed on industry by customers, key retailers, and global brands (e.g., BCR, McDonalds, Woolworths, Coles, Burger King, Costco). As a result, Australia's red meat supply chain is complex and understanding the regulatory and commercial requirements at each link in the chain is difficult to producers, processors, and retailers alike.

The term 'supply chain' is generally defined from a research or review perspective, viewing the supply chain collectively as system plus input and output. In the case of meat production and processing, this covers everything from the genetics and breed of livestock through to the product being bought or served to a consumer.

The importance of the supply chain and its 'links' is in ensuring customers and consumers of the product's integrity, security, and traceability. Despite these terms having their own specific meaning, each are commonly used interchangeably. At a basic consumer level, we are considering if the MSA graded, Grass-Fed, Eye Fillet from South-East Queensland advertised on the Norman Hotel menu for \$43.90 is exactly what it is advertised.

The RMSCC has taken this view of the final consumer and worked to map out the information-related requirements at each link in the chain that would deliver it. What has been created is a detailed map of Australia's livestock product supply chains.

The supply chains captured by the RMSCC include:

- Beef Supply Chain Model
- Small Stock (sheep, veal, and goat) Supply Chain Model
- Dairy Supply Chain Model

This document specifically refers to the Small Stock Supply Chain Model. For information regarding other supply chains please visit rmscc.org to download or view the interactive supply chain models.

4 Traceability in the Red Meat Supply Chain

4.1 What is traceability and its purpose?

As defined by the European Commission, traceability is 'the ability to trace and follow a food, feed, food-producing animal or substance intended to be, or expected to be incorporated into a food or feed, through all stages of production, processing and distribution'. This is important for food and health and safety reasons, and requires that each animal, food, or substance can be traced back through all stages of production and processing. The systematic and logical management of information, and product identification will allow unsafe foods to be effectively and efficiently removed from the marketplace where required (EUR-Lex, 2002). In addition, there is increasing demand from consumers along the food supply chain for greater transparency of food products in relation to production, quality, health, ethics, and welfare as well as authenticity and sustainability of food and its sources. To enable this, each item is required to be adequately labelled and be accompanied by the relevant documentation in accordance with rules and regulations stipulated by exporting and importing countries (The Traceability Working Group., 2019). All food and food movements can be traced one step forwards and one step backwards at any point in the supply chain (Food Standards Australia & New Zealand., 2021).

Traceability can be broken down into two components:

- 1) *Internal traceability* – processes within an organisation link the identities of raw products to those of finished goods, with each new product having a Unique Product Identifier. This linkage is maintained between each product and its original ingredients. Each item produced within a batch is identified by a Lot Number which is maintained on the product until its depletion. This include where products are packaged within larger units.
- 2) *External traceability* – each traceability partner or product handler/recipient along the supply chain can effectively trace each product back to its direct source and recipient. Here, not every member of the supply chain will have access to the entirety of the products traceability information but rather this data exists within the larger traceability system and will be available where required (Zhang & Bhatt, 2014)

4.2 What does traceability in the global small stock supply chain look like?

Traceability throughout the red meat supply chain is integral to maintaining food safety and quality assurance. This allows the protection of Australia's reputation for producing clean, safe, and natural product, underpinning its standards for a high level of product integrity and international product demand.

An effective traceability system across a supply chain will include:

- The traceability of any item one step forward and one step backward at any point in the supply chain using a globally unique identifier
- The implementation and strict adherence to traceability processes and systems by all participants within the supply chain
- All necessary linkages between inputs and outputs of internal traceability systems are maintained (Zhang & Bhatt, 2014).

The small stock supply chain utilises the Meat Messaging system for the traceability of meat products across the supply chain from the slaughter of the animal. Prior to this, the National Livestock Identification program ensures the traceability of the live animal from birth to slaughter. The "Meat Messaging" system is based on the GS1 standards for numbering and barcoding of meat products and the GS1 EANCOM electronic message standards. Refer to the GS1 organisation in your country for details on the GS1 standards.

The "Meat Messaging" system is an online tool for the creation, sending, receiving, attestation statements and compliance declaration of meat products (carton, carcasses, carcase portions, pallets, bulk packs, and containers) GS1 EANCOM messages. These messages assist regulatory authorities with the authenticity, verification, and traceability of meat products. The GS1 barcoding standards and GS1 EANCOM electronic message standards do not replace existing regulatory requirements, they assist and supplement these requirements.

In an effort to improve food safety and traceability, the United States Food and Drug Administration (FDA) requires additional record keeping requirements (in addition to those existing within current regulations) for persons who manufacture, process, pack, or hold foods on the Food Traceability List (FTL). While these requirements only apply to those items on the FTL, the standards are designed to be implemented within all FDA-regulated supply chains. These additional records include the capturing of Key Data Elements (KDEs) and associated Critical Tracking Events (CTEs).

4.3 What are Critical Tracking Events?

Critical Tracking Events (CTEs) are activities in the supply chain that should be documented by the capture of key information (Key Data Elements i.e., KDEs) for each event to accurately trace product movement up or down the supply chain. In short, CTEs are those events whereby product is transported between premises, transformed into new products or depleted. Each of these CTE events involve inputs and outputs and thus subcategories can be created. These CTE categories and subcategories are defined in Figure 2 below.

CRITICAL TRACKING EVENT DEFINITIONS		
TRANSFORMATION-TYPE EVENTS <i>events that typically support internal traceability within the four walls of a supply chain company</i>	TRANSFORMATION (T1) INPUT	An event where one or more materials are used to produce a traceable product that enters the supply chain. (NOTE: Materials used to produce products for immediate consumption by consumers are reported as Consumption events)
	TRANSFORMATION (T2) OUTPUT	An event where a created traceable product is packaged and labeled for entry into the supply chain.
TRANSPORTATION-TYPE EVENTS <i>events that typically support external traceability between supply chain companies</i>	SHIPPING (S) EVENT	An event where traceable product is dispatched from a defined location to another defined location
	RECEIVING (R) EVENT	An event where traceable product is received at a defined location from another defined location.
DEPLETION-TYPE EVENTS <i>events that capture how traceable product is removed from the supply chain</i>	CONSUMPTION (C) EVENT	An event where a traceable product becomes available to consumers (Point-of-Sale or Prepared).
	DISPOSAL (D) EVENT	An event where a traceable product is destroyed or discarded or otherwise handled in a manner that the product can no longer be used as a food ingredient or become available to consumers.

Figure 2. Critical Tracking Event (CTE) definitions. Source: GS1US (2014).

Figure 3 below shows the common CTEs summarised by supply chain segment. It is important to not the process may change depending on the structure of the company, and its individual supply chain as well as the specific product output.

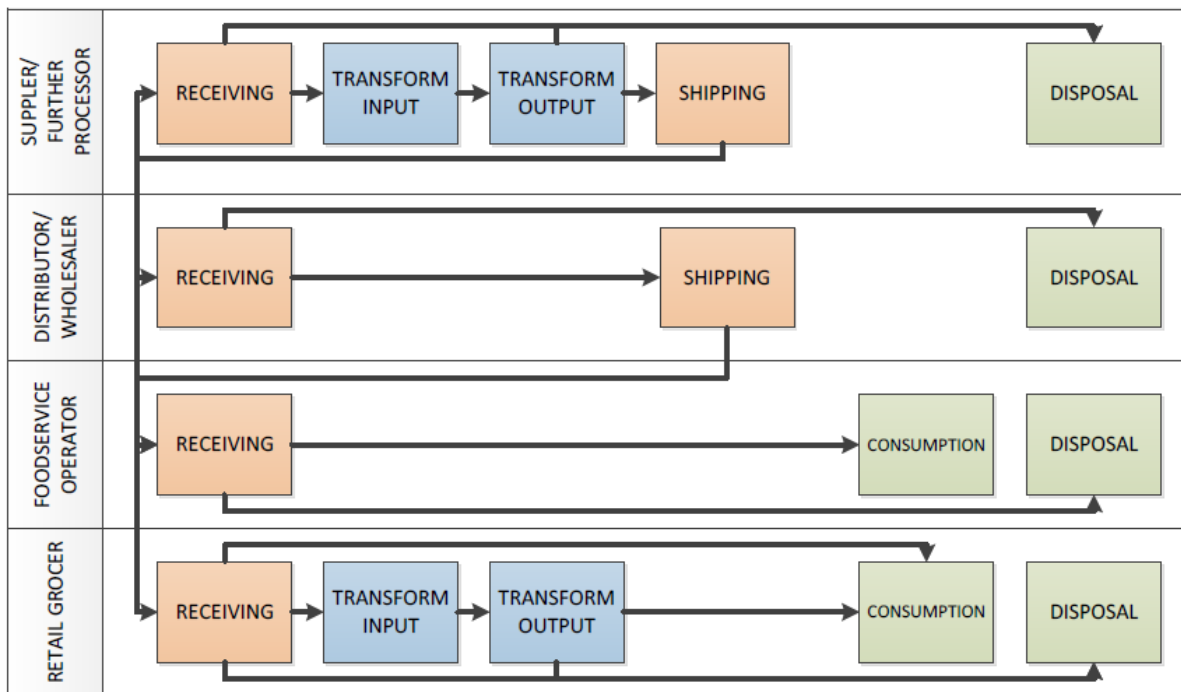

Figure 3. Common Critical Tracking Events (CTEs) in the Meat Supply Chain. Source: GS1US (2014).

Certain documents within the small stock supply chain, particularly paper documents, will hold the key information of KDE associated with the traceability of the item at each CTE. These may include documents such as Delivery Dockets, Receipts of Purchase, Product Tickets, and other regulated documents and are transported with products as they move throughout the internal and external traceability systems of the supply chain. Where data is transferred electronically, the electronic system are considered the CTE related documentation.

4.4 What are Key Data Elements?

GS1 defines Key Data Elements (KDEs) as data elements associated with each critical tracking event which provide:

- 1) Essential information about time and place of the event, the party reporting the event, and the identification of the product involved; and
- 2) Related essential information about the transformation, transportation, or depletion from the supply chain of a traceable product.

KDEs associated with each Critical Tracking Event should allow the following five **W**'s to be determined:

- **Who** performed the activity,
- **What** product was involved,
- **When** was it done,
- **Where** was it done,
- **Why** the event is reported.

Some key data elements are more essential than others for understanding the event. Required KDEs are consistently essential when reporting an event, such as event owner, location, and date and time, while other elements are best practice or conditional KDEs, depending on event circumstances or if data values are available for capture. The following KDEs for each CTE included in the meat supply chain are shown in Figure 4 below.

Key Data Element	Transport		Transformation		Depletion	
	Shipping	Receiving	Input	Output	Consumption	Disposal
Event Type	R	R	R	R	R	R
Event Owner	R	R	R	R	R	R
Date	R	R	R	R	R	R
Time	R	R	R	R	R	R
Event Location	R	R	R	R	R	R
Item ID Type	R	R	R	R	R	R
Item ID	R	R	R	R	R	R
Batch/Lot/Serial#	BP*	BP	R	R	BP	BP
Quantity	R	R	R	R	R	R
Unit of Measure	R	R	R	R	R	R
Batch/Lot Relevant Date	C^	C	C	C^	BP	BP
Activity Type	C	C	R	R		
Activity ID	C	C	R	R		
Supplier Identity	C	C	C	C		
Trading Partner Location	R	R				
R = Required Data						
C = Conditional Data; The need for this data would be determined by business circumstances;						
^ Relevant Date should be reported by Suppliers for Shipping Events and for Transformation Output events.						
BP = Best practice is to capture the batch/lot number for transport and depletion events whenever possible; however, if not feasible, Batch/Lot Relevant date or Activity ID must be provided.						
* Batch/lot/serial numbers should be reported by Suppliers for Shipping events.						

Figure 4. Use of Key Data Elements (KDEs) in Critical Tracking Events (CTEs). Source: GS1US (2014).

5 The Small Stock Supply Chain Model

5.1 Introduction

The small stock supply chain is a highly complex value chain involving the transformation and transfer of a number of products throughout the various stages from breeding of the live animal, all the way through to purchase by the consumer. With this, there is an increasing requirement for the improved transparency and traceability of products and their information. Various stages of the supply chain and associated processes can be categorised into three larger sectors: the Exporting Country; International Trade; and the Importing Country. These stages can then be further divided into subcategories within these larger sectors such as Livestock, Processing and National Distribution for the Exporting Country sector of the supply chain. Each stage of the supply chain involves several Critical Tracking Events which may include the receipt, transformation and dispatch of product to the next stage in the supply chain. With these, the transfer of data or Key Data Elements occurs through the transfer of physical documentation or electronic data transfer (Figure 5). Additionally, each stage of the supply chain is governed by a number of regulatory and industry bodies.

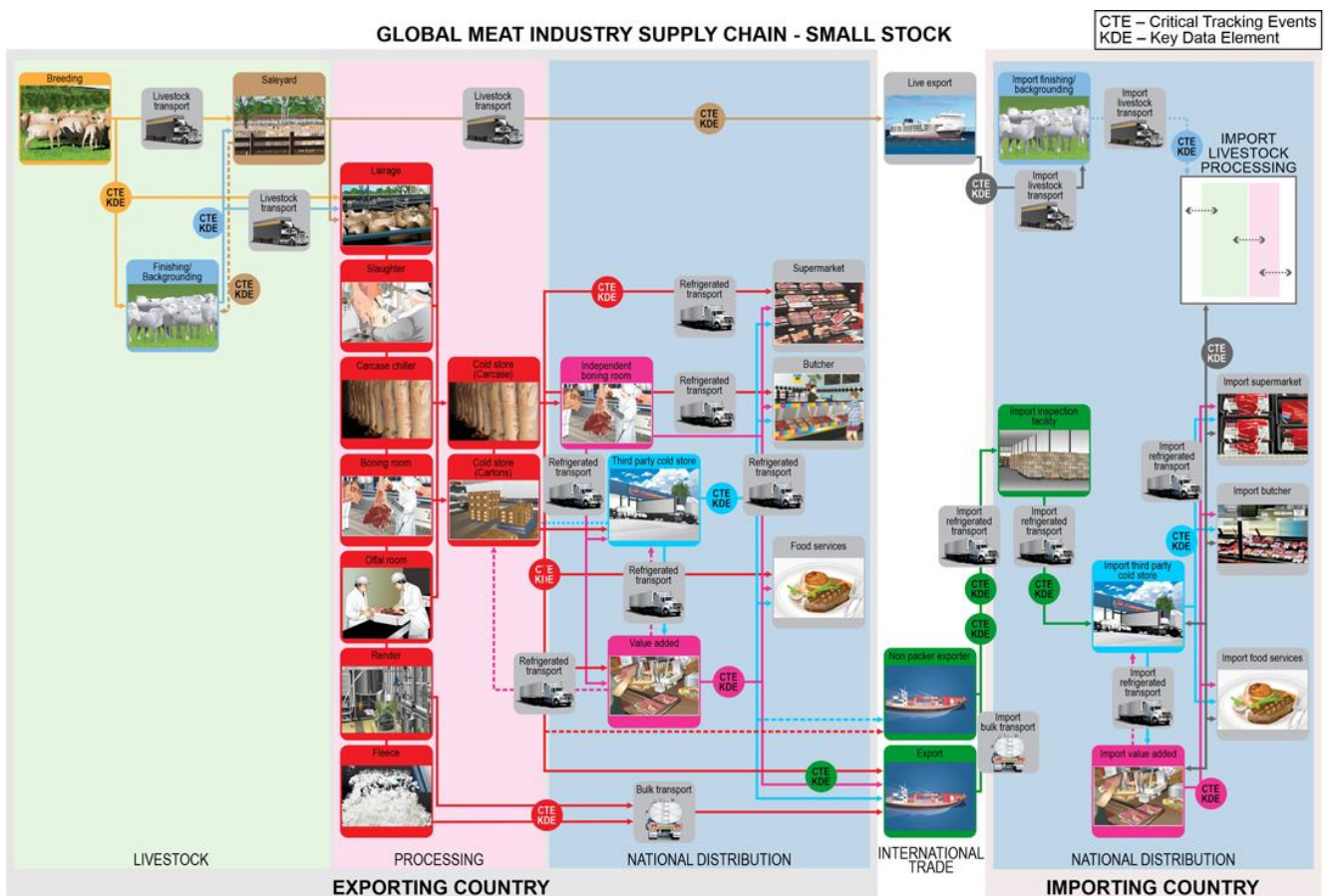

Figure 5. The global Small Stock Supply Chain Model

5.2 Supply Chain Sectors

5.2.1 Exporting Country - Livestock

5.2.1.1 Breeding

Breeding is the process in which animals are produced with a specific goal. These goals are critical to define in order to meet the needs of a producer for purchase. The market for which the animal is intended must be considered so that traits and characteristics of the animal can be accounted for in the breeding program. These characteristics might be the breed, growth rate or the fat depth of the animal.

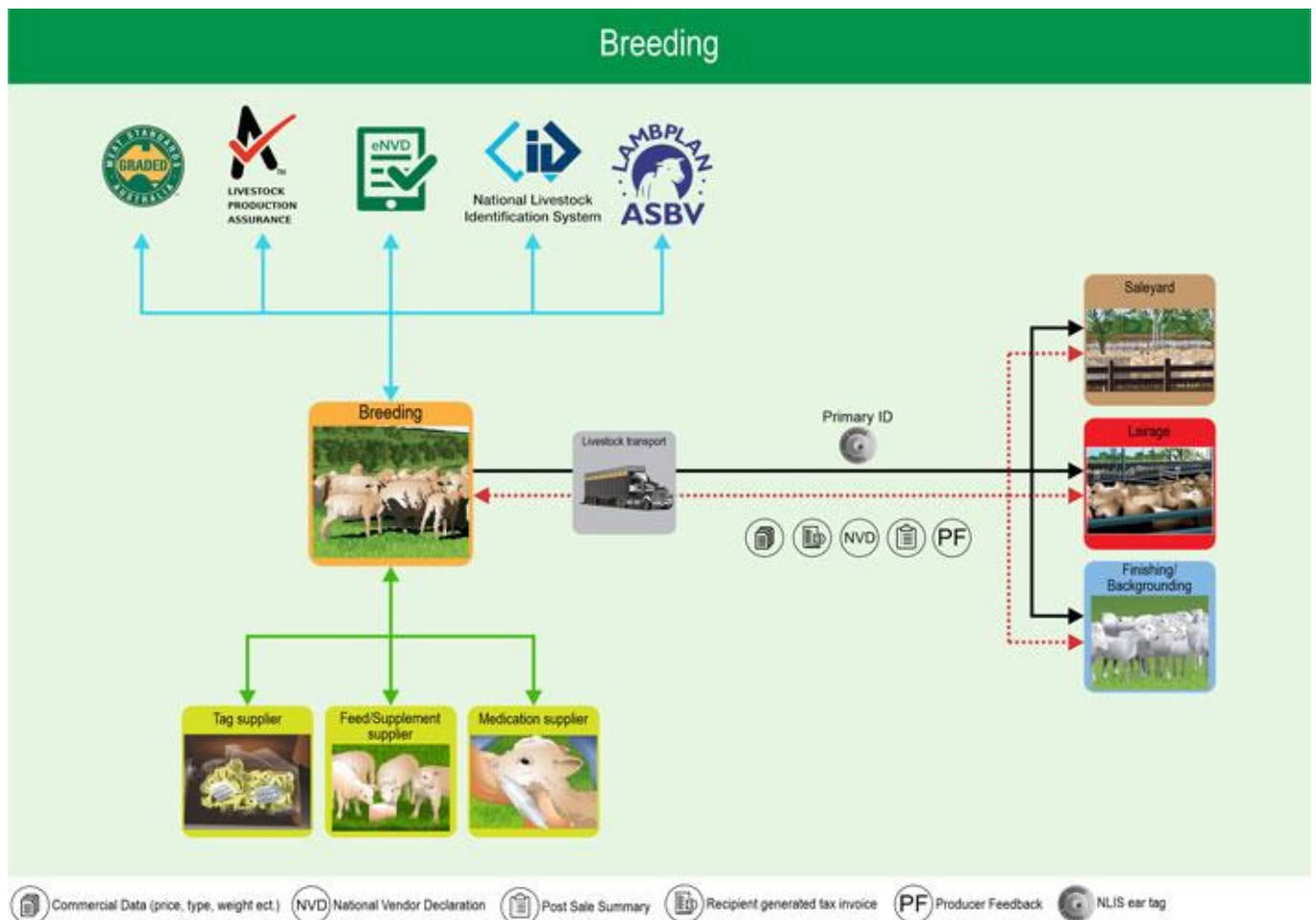

Figure 6. Inputs and outputs of the small stock supply chain breeding sector.

5.2.1.1.1 Physical Inputs including Critical Tracking Events (CTEs)

There are a range of physical inputs to a small stock breeding enterprise depending on the breeding and management strategy. These inputs typically include breeding livestock and/or artificial breeding technologies, any feed supplements and veterinary drugs that may be administered, and animal traceability tags. Information on all of these inputs must be recorded by the producer.

Critical Tracking Events (CTEs) are defined as those events which include the growing, receiving, transforming, creating, and shipping of food products. Such events are critical to the traceability of product throughout the supply chain.

The CTEs associated with inputs to the breeding system include the receipt of:

- Artificial breeding technology

- Breeding livestock
- Crop and pasture treatments
- Experts and veterinarians
- Feed supplies and supplements
- NLIS ID tags
- Veterinary drugs or other health treatments.

Table 1. Physical inputs and associated Critical Tracking Event related documents for a small stock breeding system.

Event related to the inputs	Description of the inputs	Critical Tracking Event (CTE) related documents (including electronic)	More details
Artificial breeding technology	These are technologies such as artificial insemination or embryo transfer which are used in place of or in addition to traditional livestock breeding methods.	Commercial supply contract, Receipt of purchase/Tax Invoice	
Breeding livestock	These are male and female livestock which have reached the appropriate age for breeding. Animals may be from a self-replacing herd or sourced from a seedstock breeder.	Commercial supply contract, Feed and water record, NLIS Movement Update, NVD Receipt of purchase/Tax Invoice, State specific movement forms	
Crop and pasture treatments	These are agricultural chemicals applied to crops, pastures and/or paddocks (inclusive of spot spraying) which livestock may come into contact with or consume.	Product label, Receipt of purchase/Tax Invoice	
Experts and veterinarians	These are professionals who provide services to the breeding enterprise which ensure the safety, wellbeing, and productivity of the livestock.	Receipt of purchase/Tax Invoice, Veterinary prescription	
Feed supplies and supplements	These are supplementary animal feed products such as hay or silage fodder, or mineral supplements which are provided to ensure the production efficiency and health of livestock are maintained. This may also include clean drinking water e.g., where livestock are in transit or at saleyards.	Commodity Vendor Declaration (CVD), Receipt of purchase/Tax Invoice	
NLIS ID tags	These are animal identification tags with a unique number which must be attached to animals moved off a PIC for traceability purposes.	NLIS Movement Update	
Veterinary drugs or other health treatments	These may be prescribed, or non-prescribed treatments or medications given to ensure the health and wellbeing of the livestock.	Receipt of purchase/Tax Invoice, Veterinary prescription	

5.2.1.1.2 Information Inputs including Key Data Elements (KDEs)

Key Data Elements (KDEs) are defined as those elements which are key in identifying and tracing the Critical Tracking Event (CTE). There are a range of information inputs that are essential for the traceability of management practices, animal movements and treatments applied to the small stock in a breeding enterprise. It is essential that all of these inputs are recorded by the producer for auditing purposes.

Table 2. Information inputs, Key Data Elements and Critical Tracking Event related documentation for a small stock breeding system.

Attributes (including KDEs)	Description of the Attributes (including KDEs)	Is a KDE	Critical Tracking Event (CTE) related documents (including electronic)	More details
Agreement date	This is the date on which an agreement between two parties was made.	Yes	Commercial supply contract	
APVMA approval number	This is a unique number allocated to each label by the APVMA.	Yes	Commodity Vendor Declaration, NVD, Product label	For more information visit the Australian Pesticides and Veterinary Medicine Authority.
Batch number	This is a unique number which identifies products sharing certain production characteristics and is used for traceability purposes.	Yes	Commodity Vendor Declaration, NVD, Product label	
Company/product code	This is an in-house code for the identification of the product in the unit.	Yes	Feed and water record, Receipt of purchase/Tax Invoice	
Contract number	This is a unique number allocated to the contract by the seller.	Yes	Commercial supply contract, Commodity Vendor Declaration	
Date	This is the date of signing or of which a record entry or transaction was made.	Yes	Commercial supply contract, Commodity Vendor Declaration, Feed and water record, NVD, Receipt of purchase/Tax Invoice, State specific movement forms	
From PIC	The Property Identification Code from/to where the livestock or product were consigned.	Yes	Commodity Vendor Declaration, NLIS Movement Update, NVD, State specific movement forms	For more information visit the Integrity systems website.
Movement date	The date on which livestock or other products (e.g., feed or meat products) were transported between PICs/establishments.	Yes	Commercial supply contract, Commodity Vendor Declaration, NLIS Movement Update, NVD, State specific movement forms	
National Grower Registration Number	A unique number assigned to individuals registered with the National Grower Register, an online business register for Australian growers.	Yes	Commodity Vendor Declaration	
NLIS Tag Number/RFID	All animals transported between PICs must have a permanent National Livestock Identification System tag attached. This tag has a unique animal identification number.	Yes	NLIS Movement Update	
NVD Serial Number	Each NVD form has a unique serial number.	Yes	NLIS Movement Update, NVD	For more information visit the Integrity systems website.

Attributes (including KDEs)	Description of the Attributes (including KDEs)	Is a KDE	Critical Tracking Event (CTE) related documents (including electronic)	More details
Prescription number	A unique certificate number issued for traceability purposes.	Yes	Veterinary prescription	
Product code/description	This is a unique identifier or description assigned by the seller to each product type marketed or for sale.	Yes	Commodity Vendor Declaration	
Recipient Australian Business Number (ABN)	This is an 11-digit registration number, issued by the Australian Tax Office, used to identify businesses.	Yes	Feed and water record, Receipt of purchase/Tax Invoice	For more information visit the ATO website.
Seller/Supplier Australian Business Number (ABN)	This is an 11-digit registration number, issued by the Australian Tax Office, used to identify businesses.	Yes	Feed and water record, Receipt of purchase/Tax Invoice	For more information visit the ATO website.
To PIC	The Property Identification Code from/to where the livestock or product were consigned.	Yes	Commodity Vendor Declaration, NLIS Movement Update, NVD, State specific movement forms	For more information visit the Integrity systems website.
Transport registration number	The registration number of the vehicle in which the animals or product were transported. For shipments of product this will be a shipping container number.	Yes	NVD	
Treatment date	The date on which a treatment or product was applied to a unit e.g., paddock, animal, fodder etc.	Yes	Commodity Vendor Declaration, Feed and water record, NVD	
Veterinary Registration Number	A unique number issued to veterinarians who are registered to practice, under the state legislative requirements, within the state in which they reside.	Yes	Veterinary prescription	

5.2.1.1.3 Physical Outputs including Critical Tracking Events (CTEs)

The physical outputs of a small stock breeding enterprise are weaners to be sold on for small stock meat production or retained for breeding. Other outputs may include cull or unwanted breeding stock.

Critical Tracking Events (CTEs) are defined as those events which include the growing, receiving, transforming, creating, and shipping of food products. Such events are critical to the traceability of product throughout the supply chain.

The CTEs associated with the outputs of the breeding system include the movement of:

- Weaners
- Cull livestock

off the property, premises, or supply chain sector.

Table 3. Physical outputs and associated Critical Tracking Event related documents for a small stock breeding system.

Event related to the inputs	Description of the inputs	Critical Tracking Event (CTE) related documents (including electronic)	More details
Weaners	These are young livestock to be raised for meat production and breeding.	Commercial supply contract, Feed and water record, MSA Declaration, NLIS Movement Update, NVD, Receipt of purchase/Tax Invoice, State specific movement forms	
Cull livestock	These are any unwanted livestock to be removed from the herd due to factors such as poor performance or age.	Commercial supply contract, Feed and water record, MSA Declaration, NLIS Movement Update, NVD, Receipt of purchase/Tax Invoice, State specific movement forms	

5.2.1.1.4 Information Outputs including Key Data Elements (KDEs)

Key Data Elements (KDEs) are defined as those elements which are key in identifying and tracing the Critical Tracking Event (CTE). Information outputs of the breeding enterprise include those that are related to enterprise productivity and animal traceability such as the movement date, NLIS ID number, PIC, and any health treatments or chemical exposure.

Table 4. Information outputs, Key Data Elements and Critical Tracking Event related documentation for a small stock breeding system.

Attributes (including KDEs)	Description of the Attributes (including KDEs)	Is a KDE	Critical Tracking Event (CTE) related documents (including electronic)	More details
Agreement date	This is the date on which an agreement between two parties was made.	Yes	Commercial supply contract	
APVMA approval number	This is a unique number allocated to each label by the APVMA.	Yes	NVD	For more information visit the Australian Pesticides and Veterinary Medicine Authority.
Batch number	This is a unique number which identifies products sharing certain production characteristics and is used for traceability purposes.	Yes	NVD	
Company/product code	This is an in-house code for the identification of the product in the unit.	Yes	Feed and water record, Receipt of purchase/Tax Invoice	
Contract number	This is a unique number allocated to the contract by the seller.	Yes	Commercial supply contract	
Date	This is the date of signing or of which a record entry or transaction was made.	Yes	Commercial supply contract, Feed and water record, MSA Declaration, NVD, Receipt of purchase/Tax Invoice, State specific movement forms	

From PIC	The Property Identification Code from/to where the livestock or product were consigned.	Yes	MSA Declaration, NLIS Movement Update, NVD, State specific movement forms	For more information visit the Integrity systems website.
Movement date	The date on which livestock or other products (e.g., feed or meat products) were transported between PICs/establishments.	Yes	Commercial supply contract, MSA Declaration, NLIS Movement Update, NVD, State specific movement forms	
Movement time	This is the time at which livestock were moved from the property (PIC) of origin. Direct consignments travelling to processors by road must be slaughtered with 48 hours of dispatch.	Yes	MSA Declaration	
MSA Declaration Serial Number	Each MSA Declaration form has a unique serial number.	Yes	MSA Declaration	For more information on MSA visit the MLA website.
MSA Licence Number	Any establishment consigning, supplying or identifying MSA Certified Product must be registered and have a unique MSA Licence Number.	Yes	MSA Declaration, Receipt of purchase/Tax Invoice	For more information on MSA visit the MLA website.
NLIS Tag Number/RFID	All animals transported between PICs must have a permanent National Livestock Identification System tag attached. This tag has a unique animal identification number.	Yes	NLIS Movement Update	
NVD Serial Number	Each NVD form has a unique serial number.	Yes	NLIS Movement Update, NVD	For more information visit the Integrity systems website.
Producer/Vendor MSA Registration Number	Producers consigning small stock to MSA markets are required to be registered and have a unique MSA Registration Number.	Yes	MSA Declaration	
Recipient Australian Business Number (ABN)	This is an 11-digit registration number, issued by the Australian Tax Office, used to identify businesses.	Yes	Feed and water record, Receipt of purchase/Tax Invoice	For more information visit the ATO website.
Seller/Supplier Australian Business Number (ABN)	This is an 11-digit registration number, issued by the Australian Tax Office, used to identify businesses.	Yes	Feed and water record, Receipt of purchase/Tax Invoice	For more information visit the ATO website.
To PIC	The Property Identification Code from/to where the livestock or product were consigned.	Yes	NLIS Movement Update, NVD, State specific movement forms	For more information visit the Integrity systems website.
Transport registration number	The registration number of the vehicle in which the animals or product were transported. For shipments of product this will be a shipping container number.	Yes	NVD	

Treatment date	The date on which a treatment or product was applied to a unit e.g., paddock, animal, fodder etc.	Yes	Feed and water record, NVD	
----------------	---	-----	----------------------------	--

5.2.1.1.5 Regulatory and Industry Programs

- LAMBPLAN
- Sheep Producers Australia
- eNVD
- Livestock Production Assurance (LPA)
- Meat Standards Australia (MSA)
- National Livestock Identification System (NLIS)

5.2.1.1.6 Supply Chain Node Traceability

The National Livestock Identification System (NLIS) is the Australian livestock traceability program which is administered by Integrity Systems Company (ISC). Where stipulated by State legislation and certain export markets, the NLIS system requires all animals bought, sold, and moved along the supply chain to be tagged with an accredited NLIS ID tag. In some states, these tags require only the visual display of the Property Identification Code (PIC), while other states require each tag to have an individualised NLIS tag number or Radio Frequency Identifier (RFID) for the traceability of the animal throughout its lifetime. Every property which holds livestock must have a Property Identification Code (PIC) to which the livestock are assigned in the NLIS Database. Each time livestock are transferred between PICs within Australia they must be accompanied by a livestock movement declaration, such as the National Vendor Declaration (NVD) form. This document typically outlines the transporter details, consignment details, compliance with intended market specifications, withholding periods, and the details of the new property PIC. All livestock movements between PICs require an NLIS movement update to be made by either or both the consigner and receiver. Where NLIS ID tags are lost livestock must be issued with a new post-breeder tag if not on the PIC of birth and this reconciled in the NLIS Database.

5.2.1.1.7 Data flow diagrams

Table 5. Data flow diagrams for the inputs and outputs of a small stock breeding system.

Direction	Description
Output	Breeding to Saleyard
Output	Breeding to Backgrounding
Output	Breeding to Finishing (grain or grass)
Output	Breeding to Lairage

5.2.1.1.7.1 Breeding to Saleyard

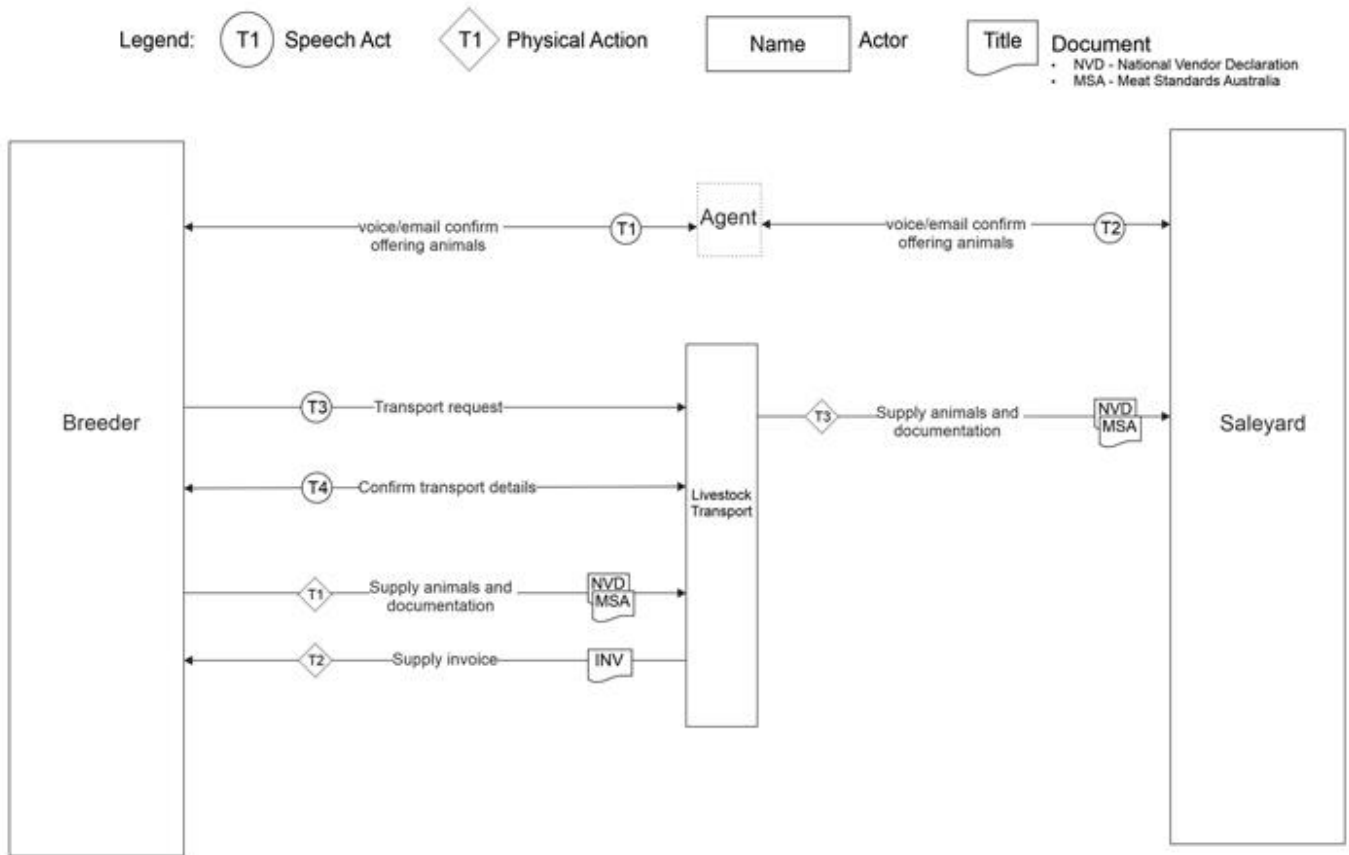

Breeding to Saleyard

Figure 7. Data or information flows from the breeding to saleyard systems in the small stock supply chain.

5.2.1.1.7.2 Breeding to Backgrounding

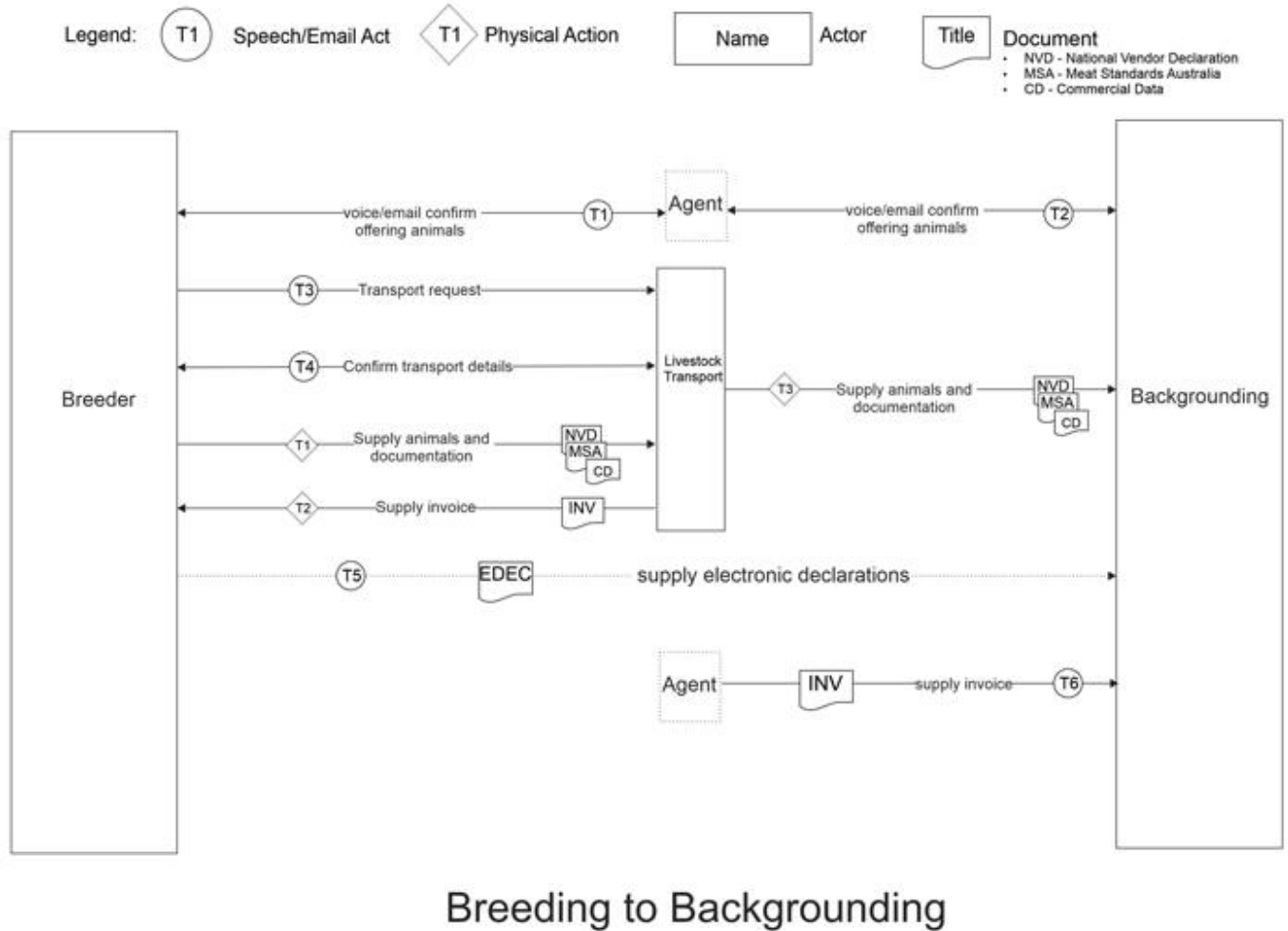

Figure 8. Data or information flows from the breeding to backgrounding systems in the small stock supply chain.

5.2.1.1.7.3 Breeding to Finishing (grain or grass)

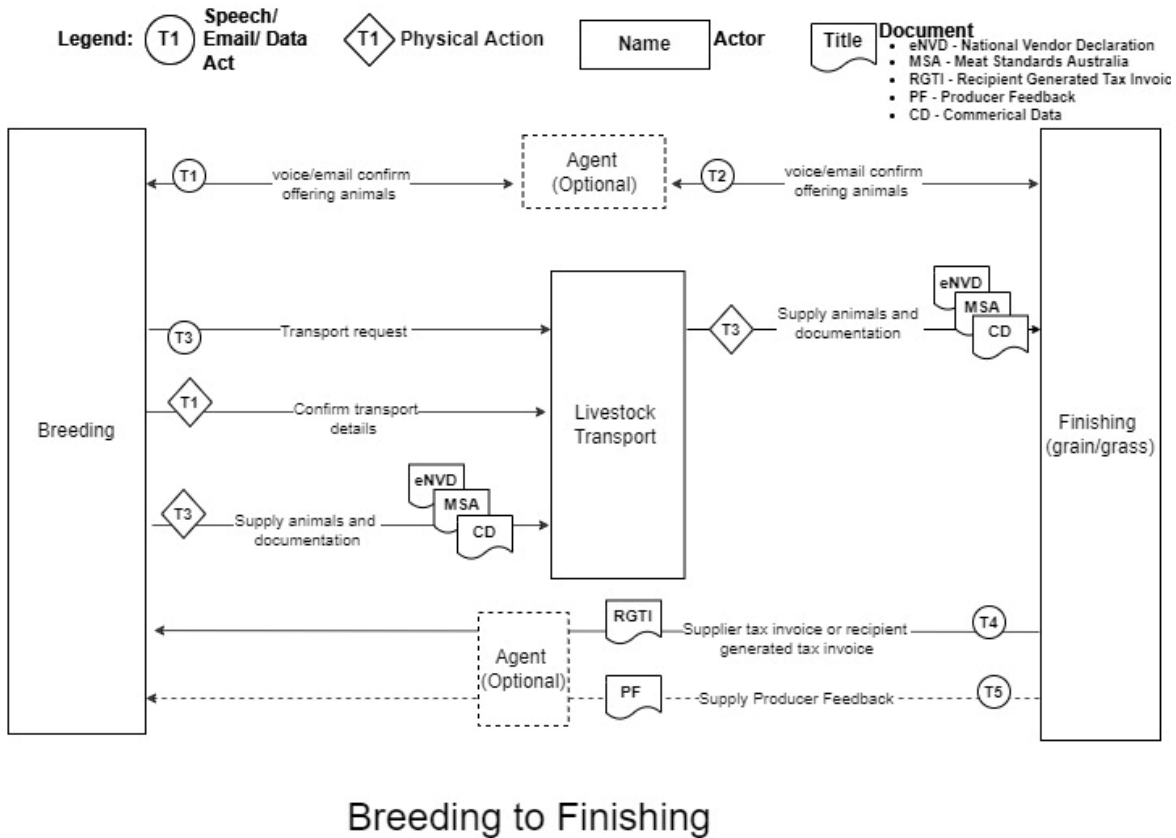

Figure 9. Data or information flows from the breeding to finishing (grain or grass) systems in the small stock supply chain.

5.2.1.1.7.4 Breeding to Lairage

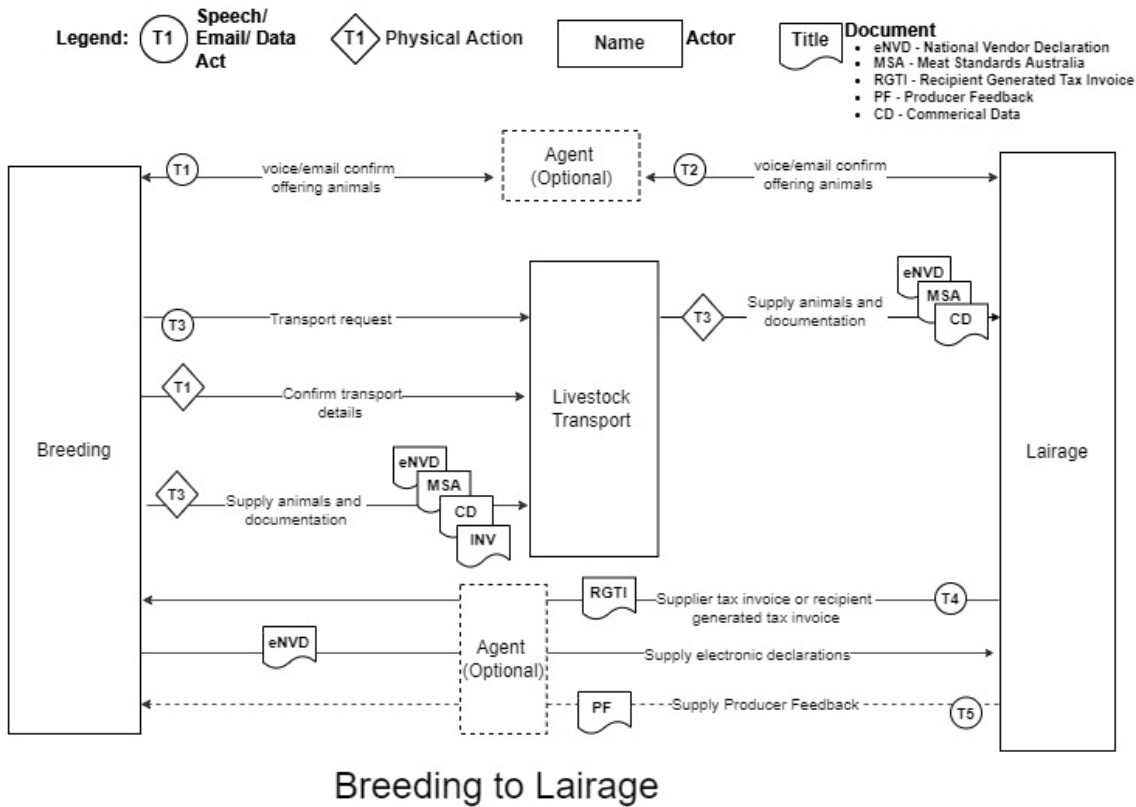

Figure 10. Data or information flows from the breeding to lairage systems in the small stock supply chain.

5.2.1.2 Finishing/Backgrounding

Backgrounding allows livestock to grow to an appropriate weight for slaughter while finishing or lot-feeding systems aim to optimise growth. In Australian small stock production systems, backgrounding is typically forage-based with animals grazing on pasture or crop stubbles. Grain rations are typically of higher quality than grass pasture and therefore improve the live weight gain of animals. Therefore, some systems may also integrate a lot-feeding component (aka feedlot) where animals are fed grain-based rations to maximise growth. In backgrounding/finishing systems there are typically three methods of grain feeding which include lib access (self-feeding), restricted feeding, and choice feeding. Further, these systems may also require nutritional supplements and health controls such as vaccination to ensure that livestock production efficiency and welfare are maximised.

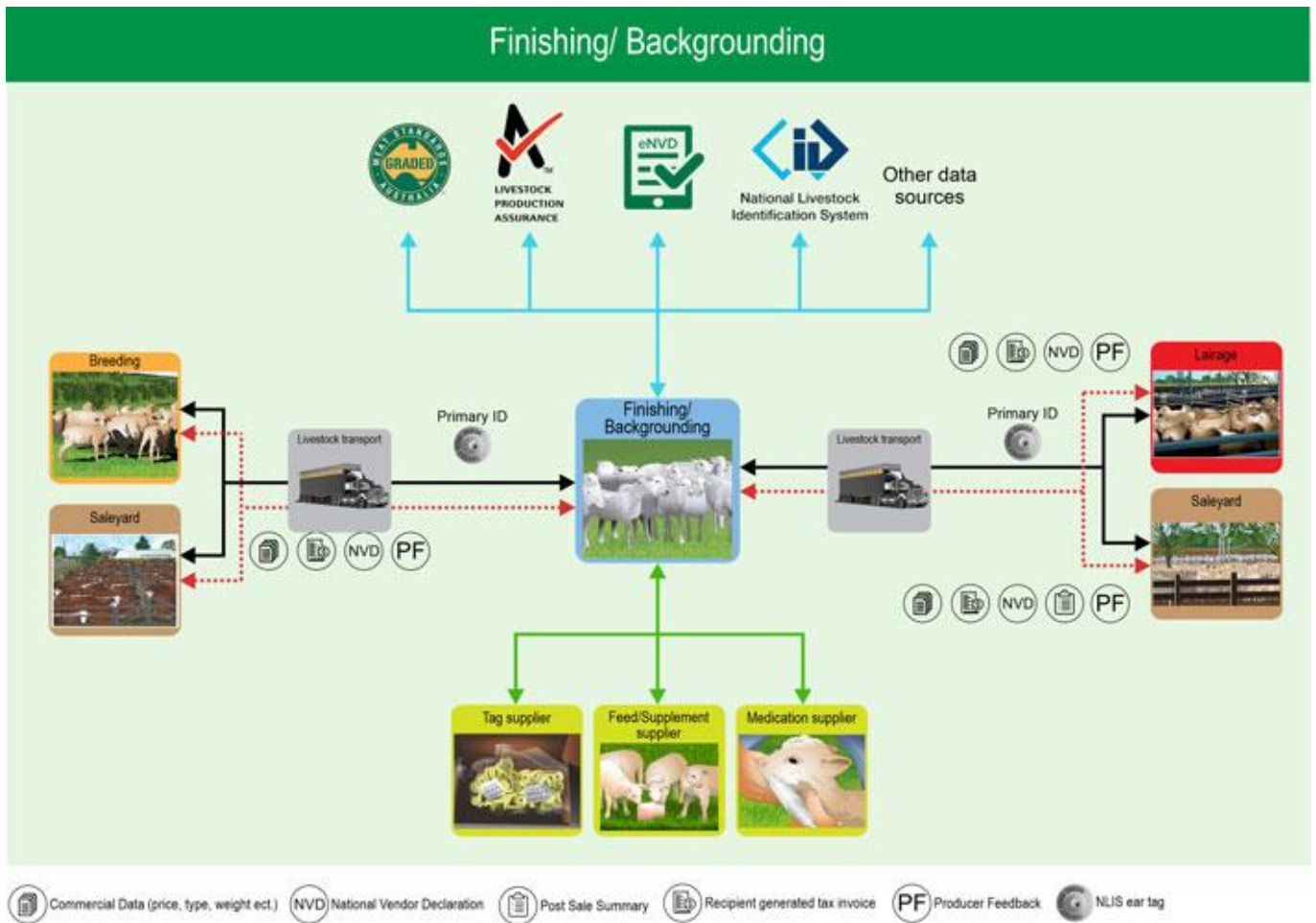

Figure 11. Inputs and outputs of the small stock supply chain finishing/backgrounding sector.

5.2.1.2.1 Physical Inputs including Critical Tracking Events (CTEs)

There are a limited number of inputs to the finishing/backgrounding supply chain section. These generally include the livestock and any feed supplements and veterinary drugs that may be administered. Information on all of these inputs must be recorded by the producer.

Critical Tracking Events (CTEs) are defined as those events which include the growing, receiving, transforming, creating and shipping of food products. Such events are critical to the traceability of product throughout the supply chain.

The CTEs associated with inputs to the finishing/backgrounding system include the receipt of:

- Small livestock
- Crop and pasture treatments
- Experts and veterinarians
- Feed supplies and supplements
- NLIS ID tags
- Veterinary drugs or other health treatments.

Table 6. Physical inputs and associated Critical Tracking Event related documents for a small stock finishing/backgrounding system.

Event related to the inputs	Description of the inputs	Critical Tracking Event (CTE) related documents (including electronic)	More details
-----------------------------	---------------------------	--	--------------

Small livestock	These are sheep or goat livestock and may include any class of animals e.g., weaners, ewe/nanny, ram/buck, cull livestock etc.	Commercial supply contract, Feed and water record, MSA Declaration, NLIS Movement Update, NVD, Receipt of purchase/Tax Invoice, State specific movement forms, Post Sale Summary	
Crop and pasture treatments	These are agricultural chemicals applied to crops, pastures and/or paddocks (inclusive of spot spraying) which livestock may come into contact with or consume.	Product label, Receipt of purchase/Tax Invoice	
Experts and veterinarians	These are professionals who provide services to the breeding enterprise which ensure the safety, wellbeing, and productivity of the livestock.	Receipt of purchase/Tax Invoice, Veterinary prescription	
Feed supplies and supplements	These are supplementary animal feed products such as hay or silage fodder, or mineral supplements which are provided to ensure the production efficiency and health of livestock are maintained. This may also include clean drinking water e.g., where livestock are in transit or at saleyards.	Commodity Vendor Declaration (CVD), Receipt of purchase/Tax Invoice	
NLIS ID tags	NLIS Movement Update	These are animal identification tags with a unique number which must be attached to animals moved off a PIC for traceability purposes.	
Veterinary drugs or other health treatments	These may be prescribed, or non-prescribed treatments or medications given to ensure the health and wellbeing of the livestock.	Receipt of purchase/Tax Invoice, Veterinary prescription	

5.2.1.2.2 Information Inputs including Key Data Elements (KDEs)

Key Data Elements (KDEs) are defined as those elements which are key in identifying and tracing the Critical Tracking Event (CTE). There are a range of measurements that are related to the inputs of finishing/backgrounding. These include the source of the small stock (PIC and ownership), transport details and any vaccinations or other treatments that the livestock have undergone. The general method for identifying small stock is through the NLIS device attached to the animals which may include a PIC or NLIS ID/RFID number. There is also likely to be a movement document such as a National Vendor Declaration (NVD) and/or Waybill which includes key traceability data.

Table 7. Information inputs, Key Data Elements and Critical Tracking Event related documentation for a small stock finishing/backgrounding system.

Attributes (including KDEs)	Description of the Attributes (including KDEs)	Is a KDE	Critical Tracking Event (CTE) related documents (including electronic)	More details
Agreement date	This is the date on which an agreement between two parties was made.	Yes	Commercial supply contract	

APVMA approval number	This is a unique number allocated to each label by the APVMA.	Yes	Commodity Vendor Declaration, NVD, Product label	For more information visit the Australian Pesticides and Veterinary Medicine Authority.
Batch number	This is a unique number which identifies products sharing certain production characteristics and is used for traceability purposes.	Yes	Commodity Vendor Declaration, NVD, Product label	
Company/product code	This is an in-house code for the identification of the product in the unit.	Yes	Feed and water record, Receipt of purchase/Tax Invoice	
Contract number	This is a unique number allocated to the contract by the seller.	Yes	Commercial supply contract, Commodity Vendor Declaration	
Date	This is the date of signing or of which a record entry or transaction was made.	Yes	Commercial supply contract, Commodity Vendor Declaration, Feed and water record, MSA Declaration, NVD, Post Sale Summary, Receipt of purchase/Tax Invoice, State specific movement forms	
From PIC	The Property Identification Code from/to where the livestock or product were consigned.	Yes	Commodity Vendor Declaration, MSA Declaration, NLIS Movement Update, NVD, Post Sale Summary, State specific movement forms	For more information visit the Integrity systems website.
Movement date	The date on which livestock or other products (e.g., feed or meat products) were transported between PICs/establishments.	Yes	Commercial supply contract, Commodity Vendor Declaration, MSA Declaration, NLIS Movement Update, NVD, State specific movement forms	
Movement time	This is the time at which livestock were moved from the property (PIC) of origin. Direct consignments travelling to processors by road must be slaughtered with 48 hours of dispatch.	Yes	MSA Declaration	
MSA Declaration Serial Number	Each MSA Declaration form has a unique serial number.	Yes	MSA Declaration	For more information on MSA visit the MLA website.
MSA Licence Number	Any establishment consigning, supplying, or identifying MSA Certified Product must be registered and have a unique MSA Licence Number.	Yes	MSA Declaration, Receipt of purchase/Tax Invoice	For more information on MSA visit the MLA website.
National Grower Registration Number	A unique number assigned to individuals registered with the National Grower Register, an online business register for Australian growers.	Yes	Commodity Vendor Declaration	

NLIS Tag Number/RFID	All animals transported between PICs must have a permanent National Livestock Identification System tag attached. This tag has a unique animal identification number.	Yes	NLIS Movement Update	For more information visit the Integrity systems website.
NVD Serial Number	Each NVD form has a unique serial number.	Yes	NLIS Movement Update, NVD, Post Sale Summary	For more information visit the Integrity systems website.
Prescription number	A unique certificate number issued for traceability purposes.	Yes	Veterinary prescription	
Producer/Vendor MSA Registration Number	Producers consigning small stock to MSA markets are required to be registered and have a unique MSA Registration Number.	Yes	MSA Declaration	For more information on MSA visit the MLA website.
Product code/description	This is a unique identifier or description assigned by the seller to each product type marketed or for sale.	Yes	Commodity Vendor Declaration	
Recipient Australian Business Number (ABN)	This is an 11-digit registration number, issued by the Australian Tax Office, used to identify businesses.	Yes	Feed and water record, Receipt of purchase/Tax Invoice	For more information visit the ATO website.
Seller/Supplier Australian Business Number (ABN)	This is an 11-digit registration number, issued by the Australian Tax Office, used to identify businesses.	Yes	Feed and water record, Receipt of purchase/Tax Invoice	For more information visit the ATO website.
To PIC	The Property Identification Code from/to where the livestock or product were consigned.	Yes	Commodity Vendor Declaration, NLIS Movement Update, NVD, Post Sale Summary, State specific movement forms	For more information visit the Integrity systems website.
Transport registration number	The registration number of the vehicle in which the animals or product were transported. For shipments of product this will be a shipping container number.	Yes	NVD	
Treatment date	The date on which a treatment or product was applied to a unit e.g., paddock, animal, fodder etc.	Yes	Commodity Vendor Declaration, Feed and water record, NVD	
Veterinary Registration Number	A unique number issued to veterinarians who are registered to practice, under the state legislative requirements, within the state in which they reside.	Yes	Veterinary prescription	

5.2.1.2.3 Physical Outputs including Critical Tracking Events (CTEs)

The outputs from finishing/backgrounding are small stock that have been prepared for movement to a saleyard for auction or sale/movement directly to a processor. There is information about the livestock that should be made available to these next links in the supply chain. This information is normally passed forward on movement

documents such as a National Vendor Declaration (NVD).

Critical Tracking Events (CTEs) are defined as those events which include the growing, receiving, transforming, creating, and shipping of food products. Such events are critical to the traceability of product throughout the supply chain.

The CTEs associated with the outputs of the finishing/backgrounding system include the movement of:

- Small livestock

off the property, premises, or supply chain sector.

Table 8. Physical outputs and associated Critical Tracking Event related documents for a small stock finishing/backgrounding system.

Event related to the inputs	Description of the inputs	Critical Tracking Event (CTE) related documents (including electronic)	More details
Small livestock	These are sheep or goat livestock and may include any class of animals e.g., weaners, ewe/nanny, ram/buck, cull livestock etc.	Commercial supply contract, Feed and water record, MSA Declaration, NLIS Movement Update, NVD, Receipt of purchase/Tax Invoice, State specific movement forms	

5.2.1.2.4 Information Outputs including Key Data Elements (KDEs)

Key Data Elements (KDEs) are defined as those elements which are key in identifying and tracing the Critical Tracking Event (CTE). The information outputs from finishing/backgrounding may include NLIS ID tag numbers, the Property Identification Code (PIC), Contract numbers and other information found Critical Tracking Event related documentation. Any details of treatments or vaccinations livestock have received (anthelmintics, etc.) will also be transferred to the next link in the supply chain.

Table 9. Information outputs, Key Data Elements and Critical Tracking Event related documentation for a small stock finishing/backgrounding system.

Attributes (including KDEs)	Description of the Attributes (including KDEs)	Is a KDE	Critical Tracking Event (CTE) related documents (including electronic)	More details
Agreement date	This is the date on which an agreement between two parties was made.	Yes	Commercial supply contract	
APVMA approval number	This is a unique number allocated to each label by the APVMA.	Yes	NVD	For more information visit the Australian Pesticides and Veterinary Medicine Authority.
Batch number	This is a unique number which identifies products sharing certain production characteristics and is used for traceability purposes.	Yes	NVD	

Company/product code	This is an in-house code for the identification of the product in the unit.	Yes	Feed and water record, Receipt of purchase/Tax Invoice	
Contract number	This is a unique number allocated to the contract by the seller.	Yes	Commercial supply contract	
Date	This is the date of signing or of which a record entry or transaction was made.	Yes	Commercial supply contract, Feed and water record, MSA Declaration, NVD, Receipt of purchase/Tax Invoice, State specific movement forms	
From PIC	The Property Identification Code from/to where the livestock or product were consigned.	Yes	MSA Declaration, NLIS Movement Update, NVD, State specific movement forms	For more information visit the Integrity systems website.
Movement date	The date on which livestock or other products (e.g., feed or meat products) were transported between PICs/establishments.	Yes	Commercial supply contract, MSA Declaration, NLIS Movement Update, NVD, State specific movement forms	
Movement time	This is the time at which livestock were moved from the property (PIC) of origin. Direct consignments travelling to processors by road must be slaughtered with 48 hours of dispatch.	Yes	MSA Declaration	
MSA Declaration Serial Number	Each MSA Declaration form has a unique serial number.	Yes	MSA Declaration	For more information on MSA visit the MLA website.
MSA Licence Number	Any establishment consigning, supplying, or identifying MSA Certified Product must be registered and have a unique MSA Licence Number.	Yes	MSA Declaration, Receipt of purchase/Tax Invoice	For more information on MSA visit the MLA website.
NLIS Tag Number/RFID	All animals transported between PICs must have a permanent National Livestock Identification System tag attached. This tag has a unique animal identification number.	Yes	NLIS Movement Update	For more information visit the Integrity systems website.
NVD Serial Number	Each NVD form has a unique serial number.	Yes	NLIS Movement Update, NVD	For more information visit the Integrity systems website.
Producer/Vendor MSA Registration Number	Producers consigning small stock to MSA markets are required to be registered and have a unique MSA Registration Number.	Yes	MSA Declaration	For more information on MSA visit the MLA website.
Recipient Australian Business Number (ABN)	This is an 11-digit registration number, issued by the Australian Tax Office, used to identify businesses.	Yes	Feed and water record, Receipt of purchase/Tax Invoice	For more information visit the ATO website.

Seller/Supplier Australian Business Number (ABN)	This is an 11-digit registration number, issued by the Australian Tax Office, used to identify businesses.	Yes	Feed and water record, Receipt of purchase/Tax Invoice	For more information visit the ATO website.
To PIC	The Property Identification Code from/to where the livestock or product were consigned.	Yes	NLIS Movement Update, NVD, State specific movement forms	For more information visit the Integrity systems website.
Transport registration number	The registration number of the vehicle in which the animals or product were transported. For shipments of product this will be a shipping container number.	Yes	NVD	
Treatment date	The date on which a treatment or product was applied to a unit e.g., paddock, animal, fodder etc.	Yes	Feed and water record, NVD	

5.2.1.2.5 Regulatory and Industry Programs

- Sheep Producers Australia
- eNVD
- Livestock Production Assurance (LPA)
- Meat Standards Australia (MSA)
- National Livestock Identification System (NLIS)
- Other data sources

5.2.1.2.6 Supply Chain Node Traceability

The National Livestock Identification System (NLIS) is the Australian livestock traceability program which is administered by Integrity Systems Company (ISC). Where stipulated by State legislation and certain export markets, the NLIS system requires all animals bought, sold, and moved along the supply chain to be tagged with an accredited NLIS ID tag. In some states, these tags require only the visual display of the Property Identification Code (PIC), while other states require each tag to have an individualised NLIS tag number or Radio Frequency Identifier (RFID) for the traceability of the animal throughout its lifetime. Every property which holds livestock must have a Property Identification Code (PIC) to which the livestock are assigned in the NLIS Database. Each time livestock are transferred between PICs within Australia they must be accompanied by a livestock movement declaration, such as the National Vendor Declaration (NVD) form. This document typically outlines the transporter details, consignment details, compliance with intended market specifications, withholding periods, and the details of the new property PIC. All livestock movements between PICs require an NLIS movement update to be made by either or both the consigner and receiver. Where NLIS ID tags are lost livestock must be issued with a new post-breeder tag if not on the PIC of birth and this reconciled in the NLIS Database.

5.2.1.2.7 Data flow diagrams

<INSERT>

5.2.1.3 Saleyard

There are many types of selling options for small livestock, from forward contracts to paddock sales. However, saleyard auctions are commonly used for live small stock sales. Saleyards are a physical location to which animals are transported and penned for a short period of time. Small stock are subsequently auctioned by livestock agents

to the highest bidder and then transported to either a backgrounding/finishing property, to lairage (intended for slaughter) or to live export.

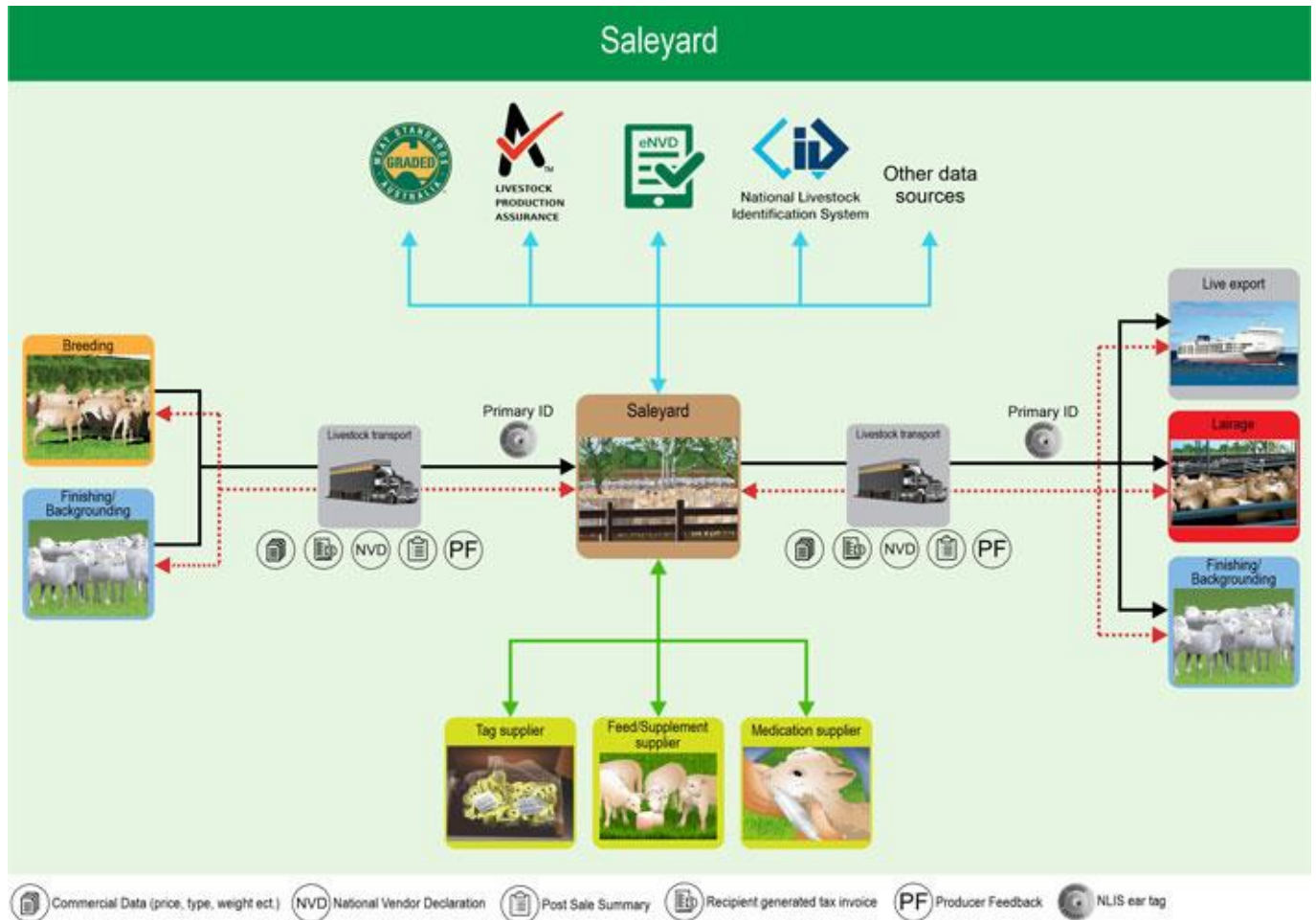

Figure 12. Inputs and outputs of the small stock supply chain saleyard sector.

5.2.1.3.1 Physical Inputs including Critical Tracking Events (CTEs)

The physical inputs bought into the saleyard selling system for livestock include the livestock themselves, experts, and veterinarians for the delivery of advice and treatments relating to animal health management, health treatments, NLIS ID tags for traceability as well as feed and water.

Critical Tracking Events (CTEs) are defined as those events which include the growing, receiving, transforming, creating, and shipping of food products. Such events are critical to the traceability of product throughout the supply chain.

The CTEs associated with inputs to the saleyard system include the receipt of:

- Small livestock
- Experts and veterinarians
- Feed supplies and supplements
- NLIS ID tags
- Veterinary drugs or other health treatments.

Table 10. Physical inputs and associated Critical Tracking Event related documents for a small stock saleyard system.

Event related to the inputs	Description of the inputs	Critical Tracking Event (CTE) related documents (including electronic)	More details
Small livestock	These are sheep or goat livestock and may include any class of animals e.g., weaners, ewe/nanny, ram/buck, cull livestock etc.	Feed and water record, MSA Declaration, NLIS Movement Update, NVD, State specific movement forms, Receipt of purchase/Tax Invoice	
Experts and veterinarians	These are professionals who provide services to the breeding enterprise which ensure the safety, wellbeing, and productivity of the livestock.	Receipt of purchase/Tax Invoice, Veterinary prescription	
Feed supplies and supplements	These are supplementary animal feed products such as hay or silage fodder, or mineral supplements which are provided to ensure the production efficiency and health of livestock are maintained. This may also include clean drinking water e.g., where livestock are in transit or at saleyards.	Commodity Vendor Declaration (CVD), Receipt of purchase/Tax Invoice	
NLIS ID tags	These are animal identification tags with a unique number which must be attached to animals moved off a PIC for traceability purposes.	NLIS Movement Update	
Veterinary drugs or other health treatments	These may be prescribed, or non-prescribed treatments or medications given to ensure the health and wellbeing of the livestock.	Receipt of purchase/Tax Invoice, Veterinary prescription	

5.2.1.3.2 Information Inputs including Key Data Elements (KDEs)

Key Data Elements (KDEs) are defined as those elements which are key in identifying and tracing the Critical Tracking Event (CTE). Information attributes and KDEs relating to the inputs of the saleyard system are those which can be drawn from the documents associated with the Critical Tracking Events. These namely include the National Vendor Declaration, any Receipts of Purchase/Tax Invoices, animal health treatments or feeding records and any other documents required under industry certification programs.

Table 11. Information inputs, Key Data Elements and Critical Tracking Event related documentation for a small stock saleyard system.

Attributes (including KDEs)	Description of the Attributes (including KDEs)	Is a KDE	Critical Tracking Event (CTE) related documents (including electronic)	More details
APVMA approval number	This is a unique number allocated to each label by the APVMA.	Yes	Commodity Vendor Declaration, NVD	For more information visit the Australian Pesticides and Veterinary Medicine Authority.
Batch number	This is a unique number which identifies products sharing certain production characteristics and is used for traceability purposes.	Yes	Commodity Vendor Declaration, NVD	

Company/product code	This is an in-house code for the identification of the product in the unit.	Yes	Feed and water record, Receipt of purchase/Tax Invoice	
Contract number	This is a unique number allocated to the contract by the seller.	Yes	Commodity Vendor Declaration	
Date	This is the date of signing or of which a record entry or transaction was made.	Yes	Commodity Vendor Declaration, Feed and water record, MSA Declaration, NVD, Receipt of purchase/Tax Invoice, State specific movement forms	
From PIC	The Property Identification Code from/to where the livestock or product were consigned.	Yes	Commodity Vendor Declaration, MSA Declaration, NLIS Movement Update, NVD, State specific movement forms	For more information visit the Integrity systems website.
Movement date	The date on which livestock or other products (e.g., feed or meat products) were transported between PICs/establishments.	Yes	Commodity Vendor Declaration, MSA Declaration, NLIS Movement Update, NVD, State specific movement forms	
Movement time	This is the time at which livestock were moved from the property (PIC) of origin. Direct consignments travelling to processors by road must be slaughtered with 48 hours of dispatch.	Yes	MSA Declaration	
MSA Declaration Serial Number	Each MSA Declaration form has a unique serial number.	Yes	MSA Declaration	For more information on MSA visit the MLA website.
MSA Licence Number	Any establishment consigning, supplying, or identifying MSA Certified Product must be registered and have a unique MSA Licence Number.	Yes	MSA Declaration, Receipt of purchase/Tax Invoice	For more information on MSA visit the MLA website.
National Grower Registration Number	A unique number assigned to individuals registered with the National Grower Register, an online business register for Australian growers.	Yes	Commodity Vendor Declaration	
NLIS Tag Number/RFID	All animals transported between PICs must have a permanent National Livestock Identification System tag attached. This tag has a unique animal identification number.	Yes	NLIS Movement Update	For more information visit the Integrity systems website.
NVD Serial Number	Each NVD form has a unique serial number.	Yes	NLIS Movement Update, NVD	For more information visit the Integrity systems website.

Prescription number	A unique certificate number issued for traceability purposes.	Yes	Veterinary prescription	
Producer/Vendor MSA Registration Number	Producers consigning small stock to MSA markets are required to be registered and have a unique MSA Registration Number.	Yes	MSA Declaration	For more information on MSA visit the MLA website.
Product code/description	This is a unique identifier or description assigned by the seller to each product type marketed or for sale.	Yes	Commodity Vendor Declaration	
Recipient Australian Business Number (ABN)	This is an 11-digit registration number, issued by the Australian Tax Office, used to identify businesses.	Yes	Feed and water record, Receipt of purchase/Tax Invoice	For more information visit the ATO website.
Seller/Supplier Australian Business Number (ABN)	This is an 11-digit registration number, issued by the Australian Tax Office, used to identify businesses.	Yes	Feed and water record, Receipt of purchase/Tax Invoice	For more information visit the ATO website.
To PIC	The Property Identification Code from/to where the livestock or product were consigned.	Yes	Commodity Vendor Declaration, NLIS Movement Update, NVD, State specific movement forms	For more information visit the Integrity systems website.
Transport registration number	The registration number of the vehicle in which the animals or product were transported. For shipments of product this will be a shipping container number.	Yes	NVD	
Treatment date	The date on which a treatment or product was applied to a unit e.g., paddock, animal, fodder etc.	Yes	Commodity Vendor Declaration, Feed and water record, NVD	
Veterinary Registration Number	A unique number issued to veterinarians who are registered to practice, under the state legislative requirements, within the state in which they reside.	Yes	Veterinary prescription	

5.2.1.3.3 Physical Outputs including Critical Tracking Events (CTEs)

The outputs from a saleyard system are small stock that have been sold to a buyer (farm, processor, exporter). For traceability purposes there is information that is required to be passed on to the next links in the supply chain and this information is associated with documents linked to the animals NLIS device such as the National Vendor Declaration or Post Sale Summary (PSS) and MSA Declaration.

Critical Tracking Events (CTEs) are defined as those events which include the growing, receiving, transforming, creating, and shipping of food products. Such events are critical to the traceability of product throughout the supply chain.

The CTEs associated with the outputs of the saleyard system include the movement of:

- Small livestock

off the property, premises, or supply chain sector.

Table 12. Physical outputs and associated Critical Tracking Event related documents for a small stock saleyard system.

Event related to the inputs	Description of the inputs	Critical Tracking Event (CTE) related documents (including electronic)	More details
Small livestock	These are sheep or goat livestock and may include any class of animals e.g., weaners, ewe/nanny, ram/buck, cull livestock etc.	Feed and water record, MSA Declaration, NLIS Movement Update, NVD, Post Sale Summary, Receipt of purchase/Tax Invoice, State specific movement forms	

5.2.1.3.4 Information Outputs including Key Data Elements (KDEs)

Key Data Elements (KDEs) are defined as those elements which are key in identifying and tracing the Critical Tracking Event (CTE). Information outputs of the saleyard system are related to small stock traceability and any health, feed or water treatments received. These are detailed on regulated documents required to be passed to the next links in the supply chain including the National Vendor Declaration Form, Post Sale Summary and any documentation relating to accreditation programs such as the MSA Declaration.

Table 13. Information outputs, Key Data Elements and Critical Tracking Event related documentation for a small stock saleyard system.

Attributes (including KDEs)	Description of the Attributes (including KDEs)	Is a KDE	Critical Tracking Event (CTE) related documents (including electronic)	More details
APVMA approval number	This is a unique number allocated to each label by the APVMA.	Yes	NVD	For more information visit the Australian Pesticides and Veterinary Medicine Authority.
Batch number	This is a unique number which identifies products sharing certain production characteristics and is used for traceability purposes.	Yes	NVD	
Company/product code	This is an in-house code for the identification of the product in the unit.	Yes	Feed and water record, Receipt of purchase/Tax Invoice	
Date	This is the date of signing or of which a record entry or transaction was made.	Yes	Feed and water record, MSA Declaration, NVD, Post Sale Summary, Receipt of purchase/Tax Invoice, State specific movement forms	
From PIC	The Property Identification Code from/to where the livestock or product were consigned.	Yes	MSA Declaration, NLIS Movement Update, NVD, Post Sale Summary, State specific movement forms	For more information visit the Integrity systems website.
Movement date	The date on which livestock or other products (e.g., feed or meat products) were transported between PICs/establishments.	Yes	MSA Declaration, NLIS Movement Update, NVD, State specific movement forms	
Movement time	This is the time at which livestock were moved from the property (PIC)	Yes	MSA Declaration	

	of origin. Direct consignments travelling to processors by road must be slaughtered with 48 hours of dispatch.			
MSA Declaration Serial Number	Each MSA Declaration form has a unique serial number.	Yes	MSA Declaration	For more information on MSA visit the MLA website.
MSA Licence Number	Any establishment consigning, supplying, or identifying MSA Certified Product must be registered and have a unique MSA Licence Number.	Yes	MSA Declaration, Receipt of purchase/Tax Invoice	For more information on MSA visit the MLA website.
NLIS Tag Number/RFID	All animals transported between PICs must have a permanent National Livestock Identification System tag attached. This tag has a unique animal identification number.	Yes	NLIS Movement Update	For more information visit the Integrity systems website.
NVD Serial Number	Each NVD form has a unique serial number.	Yes	NLIS Movement Update, NVD, Post Sale Summary	For more information visit the Integrity systems website.
Producer/Vendor MSA Registration Number	Producers consigning small stock to MSA markets are required to be registered and have a unique MSA Registration Number.	Yes	MSA Declaration	For more information on MSA visit the MLA website.
Recipient Australian Business Number (ABN)	This is an 11-digit registration number, issued by the Australian Tax Office, used to identify businesses.	Yes	Feed and water record, Receipt of purchase/Tax Invoice	For more information visit the ATO website.
Seller/Supplier Australian Business Number (ABN)	This is an 11-digit registration number, issued by the Australian Tax Office, used to identify businesses.	Yes	Feed and water record, Receipt of purchase/Tax Invoice	For more information visit the ATO website.
To PIC	The Property Identification Code from/to where the livestock or product were consigned.	Yes	NLIS Movement Update, NVD, Post Sale Summary, State specific movement forms	For more information visit the Integrity systems website.
Transport registration number	The registration number of the vehicle in which the animals or product were transported. For shipments of product this will be a shipping container number.	Yes	NVD	
Treatment date	The date on which a treatment or product was applied to a unit e.g., paddock, animal, fodder etc.	Yes	Feed and water record, NVD	

5.2.1.3.5 Regulatory and Industry Programs

- Australian Livestock Markets Association (AMLA)
- eNVD
- Livestock Production Assurance (LPA)
- Meat Standards Australia (MSA)
- National Livestock Identification System (NLIS)

- Other data sources

5.2.1.3.6 Supply Chain Node Traceability

The National Livestock Identification System (NLIS) is the Australian livestock traceability program which is administered by Integrity Systems Company (ISC). Where stipulated by State legislation and certain export markets, the NLIS system requires all animals bought, sold, and moved along the supply chain to be tagged with an accredited NLIS ID tag. In some states, these tags require only the visual display of the Property Identification Code (PIC), while other states require each tag to have an individualised NLIS tag number or Radio Frequency Identifier (RFID) for the traceability of the animal throughout its lifetime. Every property which holds livestock must have a Property Identification Code (PIC) to which the livestock are assigned in the NLIS Database. Each time livestock are transferred between PICs within Australia they must be accompanied by a livestock movement declaration, such as the National Vendor Declaration (NVD) form. This document typically outlines the transporter details, consignment details, compliance with intended market specifications, withholding periods, and the details of the new property PIC. All livestock movements between PICs require an NLIS movement update to be made by either or both the consigner and receiver. Where NLIS ID tags are lost livestock must be issued with a new post-breeder tag if not on the PIC of birth and this reconciled in the NLIS Database.

5.2.1.3.7 Data flow diagrams

Table 14. Data flow diagrams for the inputs and outputs of a small stock saleyard system.

Direction	Description
Input	Saleyard to Feedlot
Output	Feedlot to Lairage - over the hooks (direct consignment)
Output	Feedlot to Lairage - company owned
Output	Feedlot to Lairage - 3rd party kill or operator
Output	Feedlot to Saleyard

5.2.1.3.7.1 Salyard to Feedlot

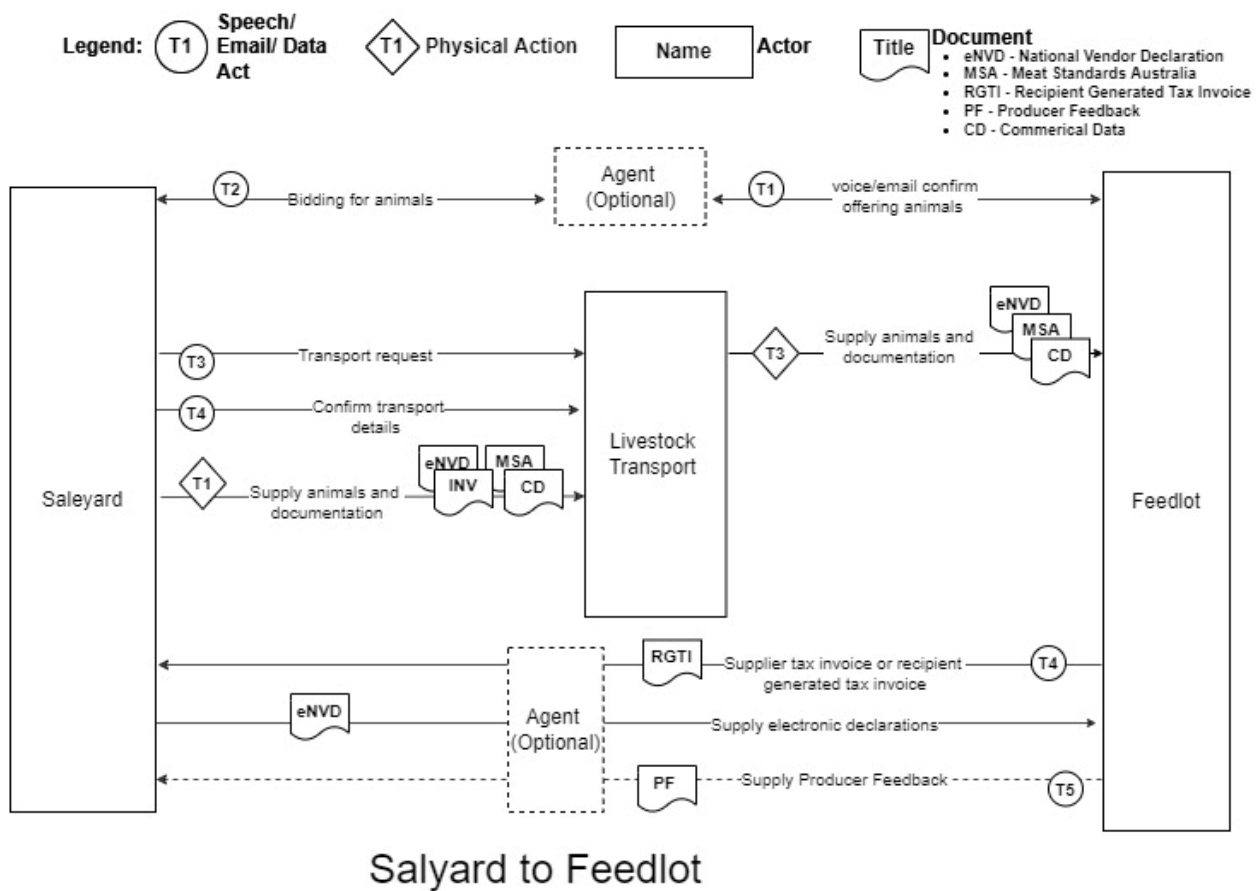
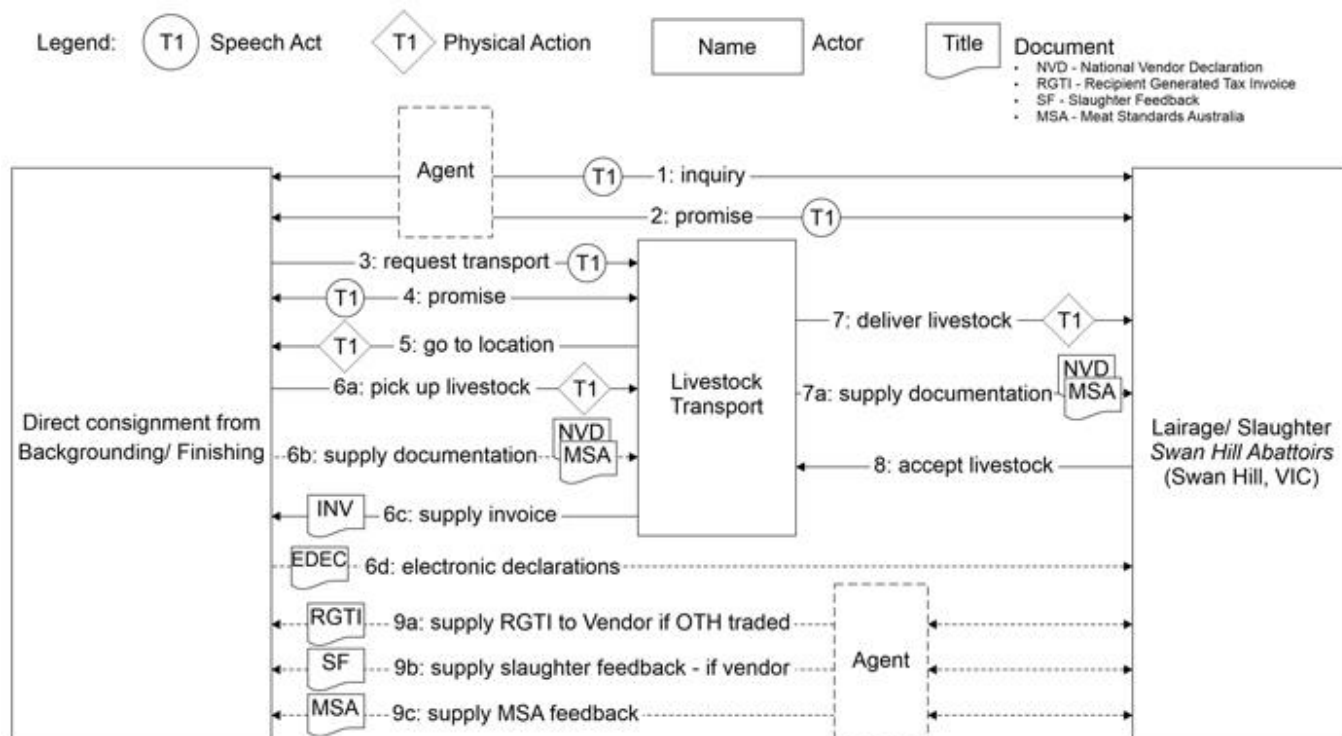

Figure 13. Data or information flows from the saleyard to feedlot systems in the small stock supply chain.

5.2.1.3.7.2 Feedlot to Lairage - over the hooks (direct consignment)



Feedlot to Lairage - Over the Hooks

Figure 14. Data or information flows from the feedlot to lairage (over the hooks direct consignment) systems in the small stock supply chain.

5.2.1.3.7.3 Feedlot to Lairage - company owned

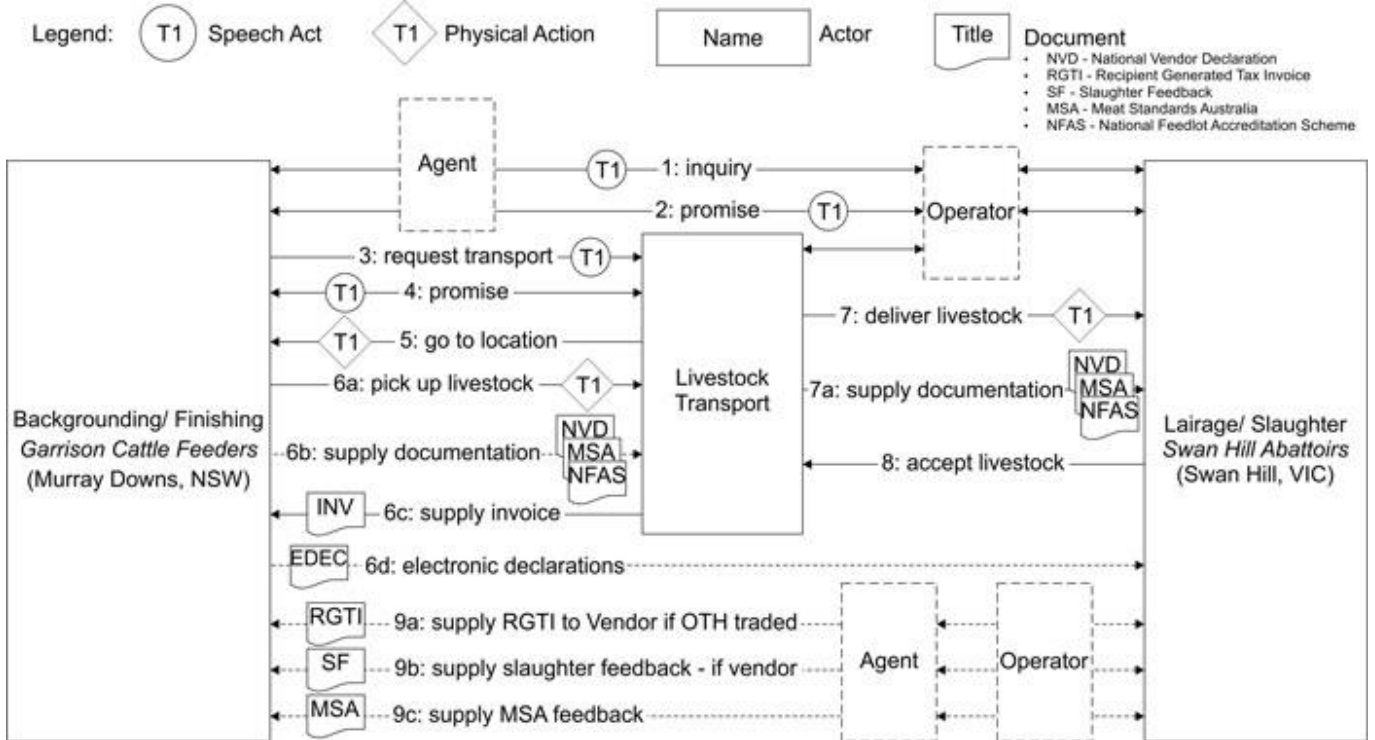

Figure 15. Data or information flows from the feedlot to lairage (company owned) systems in the small stock supply chain.

5.2.1.3.7.4 Feedlot to Lairage - 3rd party kill or operator

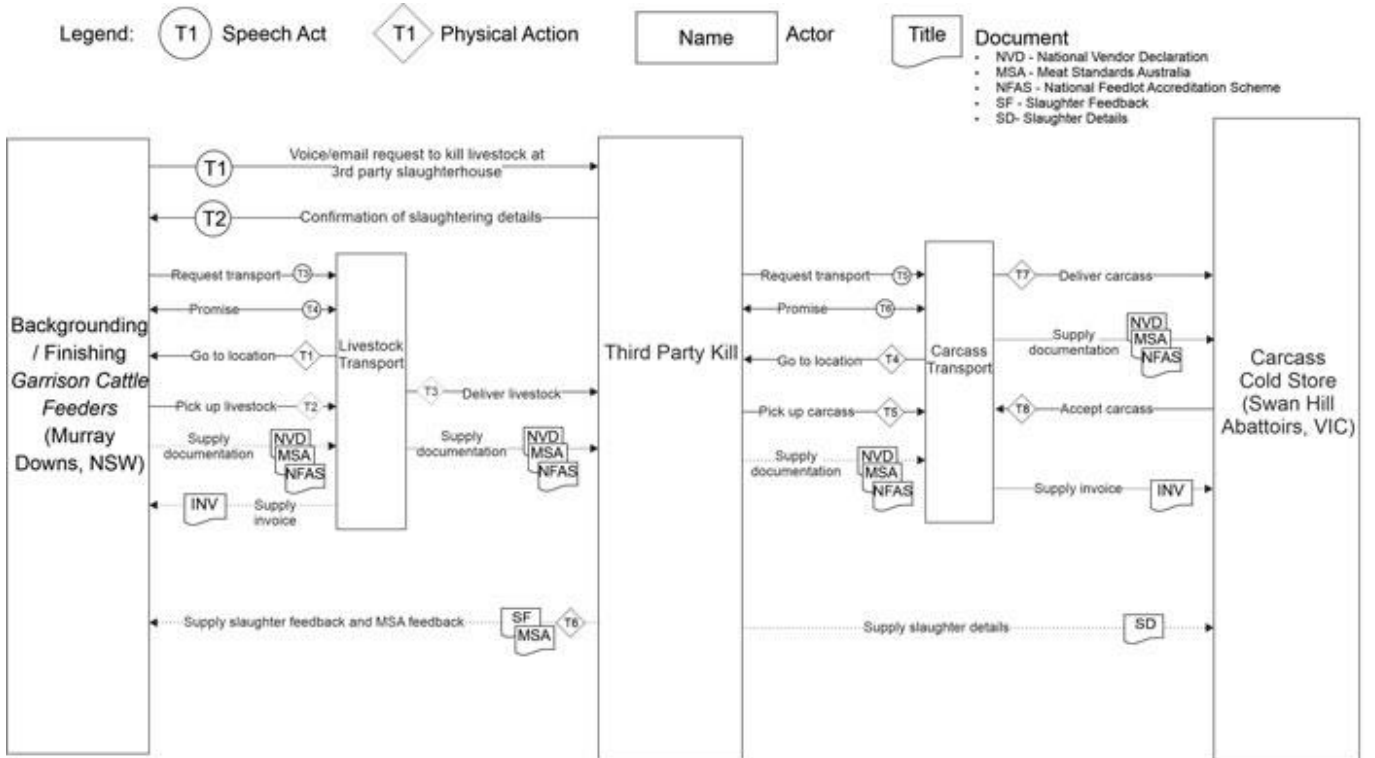

Figure 16. Data or information flows from the feedlot to lairage (3rd party kill or operator) systems in the small stock supply chain.

5.2.1.3.7.5 Feedlot to Saleyard

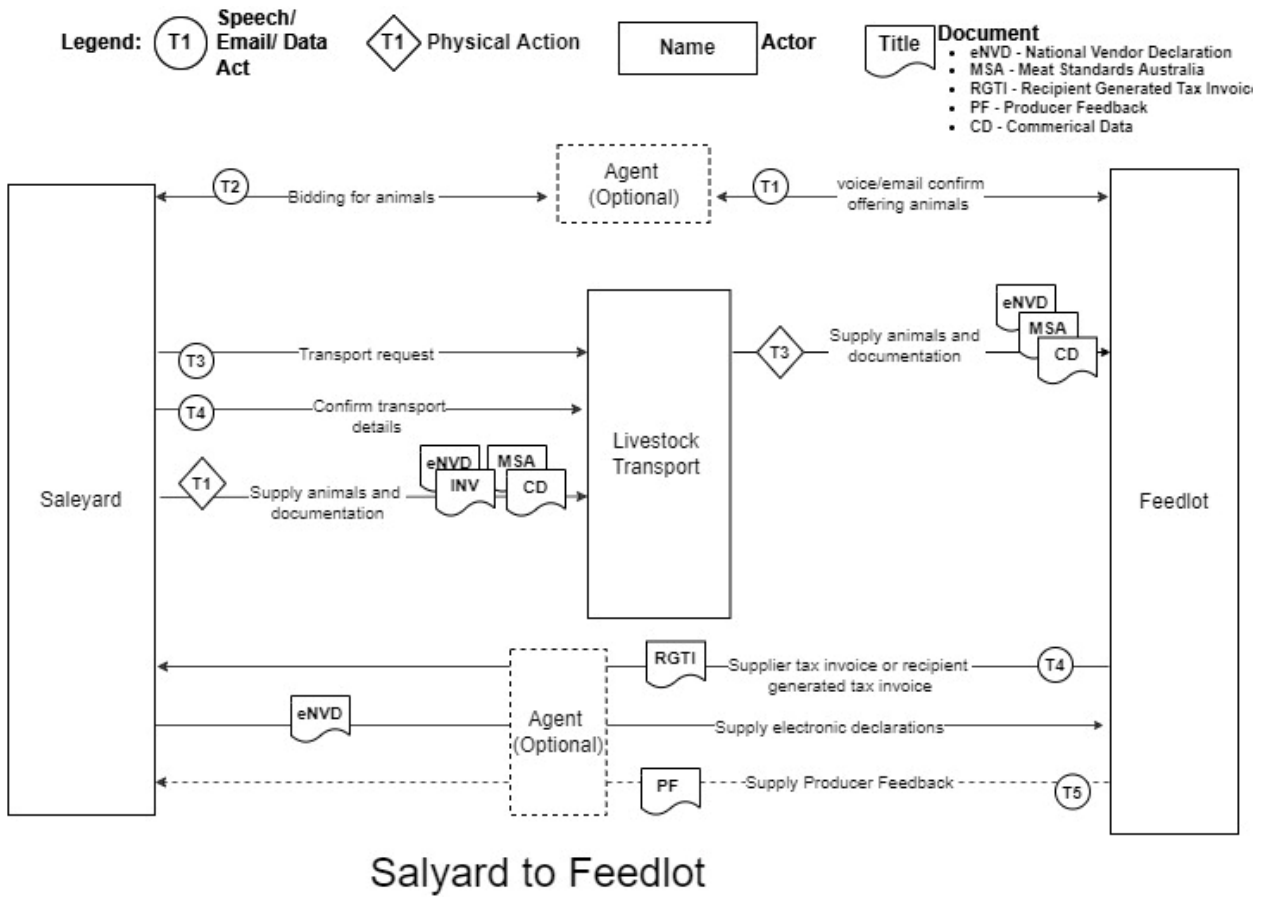

Figure 17. Data or information flows from the feedlot to saleyard systems in the small stock supply chain.

5.2.2 Exporting Country - Processing

5.2.2.1 Lairage

Lairage is the location whereby animals are rested immediately prior to slaughter. These locations are usually holding pens where animals must spend a minimum of 2 hrs before being slaughtered. Typically, animals spend between 12-24 hrs in lairage in which time they have free access to potable water.

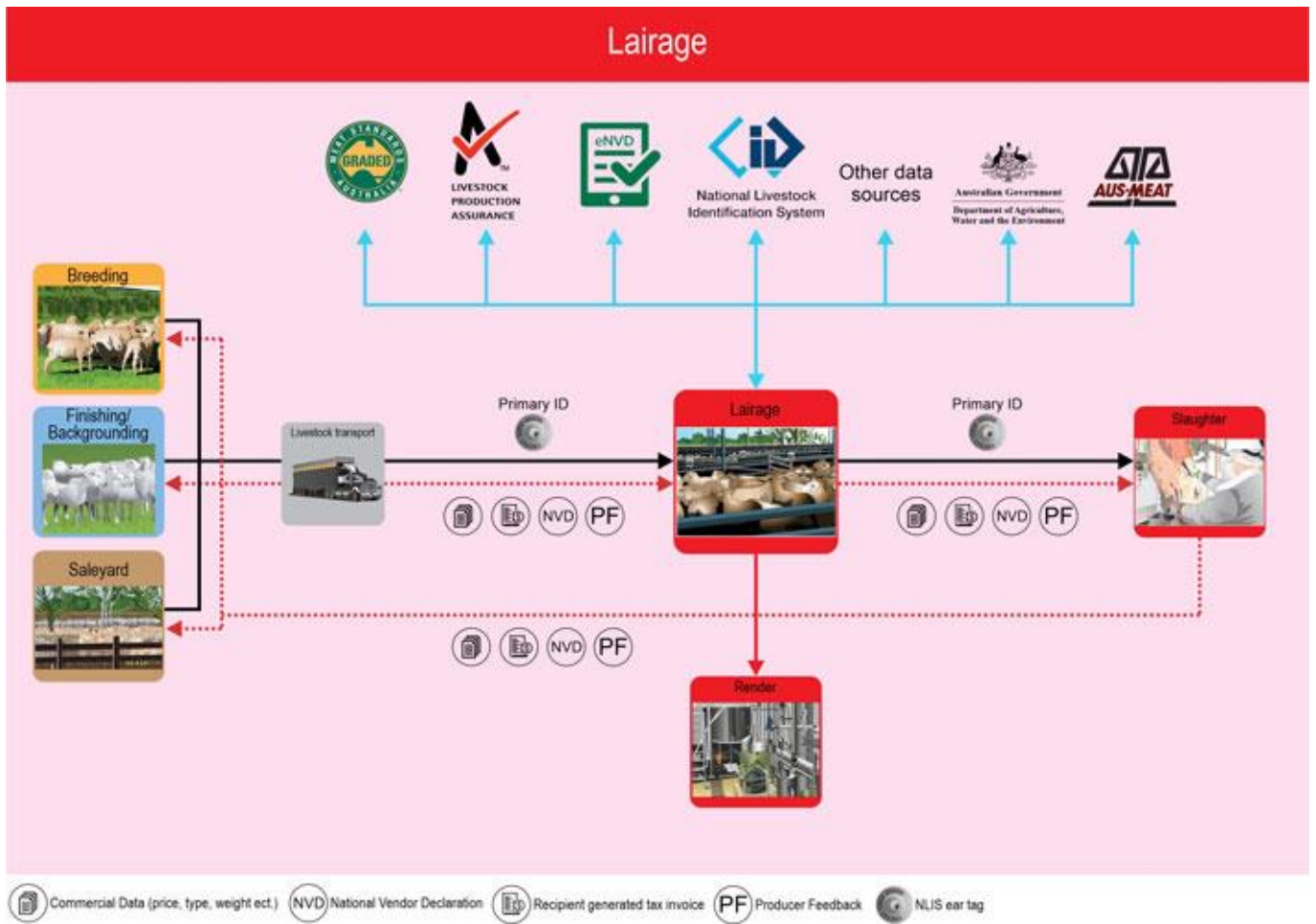

Figure 18. Inputs and outputs of the small stock supply chain lairage sector.

5.2.2.1.1 Physical Inputs including Critical Tracking Events (CTEs)

Lairage is simply the area for holding the livestock before slaughter and doesn't include any complex processes. Therefore, the inputs are minimal.

Critical Tracking Events (CTEs) are defined as those events which include the growing, receiving, transforming, creating, and shipping of food products. Such events are critical to the traceability of product throughout the supply chain.

The CTEs associated with inputs to the lairage system include the receipt of:

- Small livestock.

Table 15. Physical inputs and associated Critical Tracking Event related documents for a small stock lairage system.

Event related to the inputs	Description of the inputs	Critical Tracking Event (CTE) related documents (including electronic)	More details
Small livestock	These are sheep or goat livestock and may include any class of animals e.g., weaners, ewe/nanny, ram/buck, cull livestock etc.	Commercial supply contract, Feed and water record, MSA Declaration, NLIS Movement Update, NVD, Post Sale Summary, Receipt of purchase/Tax Invoice, State specific movement forms	

5.2.2.1.2 Information Inputs including Key Data Elements (KDEs)

Key Data Elements (KDEs) are defined as those elements which are key in identifying and tracing the Critical Tracking Event (CTE). Critical information associated with the transfer of small stock into lairage is drawn from key movement documentation such as the National Vendor Declaration form. Other information required by industry programs such as MSA is also transferred into lairage.

Table 16. Information inputs, Key Data Elements and Critical Tracking Event related documentation for a small stock lairage system.

Attributes (including KDEs)	Description of the Attributes (including KDEs)	Is a KDE	Critical Tracking Event (CTE) related documents (including electronic)	More details
Agreement date	This is the date on which an agreement between two parties was made.	Yes	Commercial supply contract	
APVMA approval number	This is a unique number allocated to each label by the APVMA.	Yes	NVD	For more information visit the Australian Pesticides and Veterinary Medicine Authority.
Batch number	This is a unique number which identifies products sharing certain production characteristics and is used for traceability purposes.	Yes	NVD	
Company/product code	This is an in-house code for the identification of the product in the unit.	Yes	Receipt of purchase/Tax Invoice	
Contract number	This is a unique number allocated to the contract by the seller.	Yes	Commercial supply contract	
Date	This is the date of signing or of which a record entry or transaction was made.	Yes	Commercial supply contract, Feed and water record, MSA Declaration, NVD, Post Sale Summary, Receipt of purchase/Tax Invoice, State specific movement forms	
From PIC	The Property Identification Code from/to where the livestock or product were consigned.	Yes	MSA Declaration, NLIS Movement Update, NVD, Post Sale Summary, State specific movement forms	For more information visit the Integrity systems website.
Movement date	The date on which livestock or other products (e.g., feed or meat products) were transported between PICs/establishments.	Yes	Commercial supply contract, MSA Declaration, NLIS Movement Update, NVD, State specific movement forms	
Movement time	This is the time at which livestock were moved from the property (PIC) of origin. Direct consignments travelling to processors by road must be slaughtered with 48 hours of dispatch.	Yes	MSA Declaration	

MSA Declaration Serial Number	Each MSA Declaration form has a unique serial number.	Yes	MSA Declaration	For more information on MSA visit the MLA website.
MSA Licence Number	Any establishment consigning, supplying, or identifying MSA Certified Product must be registered and have a unique MSA Licence Number.	Yes	MSA Declaration, Receipt of purchase/Tax Invoice	For more information on MSA visit the MLA website.
NLIS Tag Number/RFID	All animals transported between PICs must have a permanent National Livestock Identification System tag attached. This tag has a unique animal identification number.	Yes	NLIS Movement Update	For more information visit the Integrity systems website.
NVD Serial Number	Each NVD form has a unique serial number.	Yes	NLIS Movement Update, NVD, Post Sale Summary	For more information visit the Integrity systems website.
Producer/Vendor MSA Registration Number	Producers consigning small stock to MSA markets are required to be registered and have a unique MSA Registration Number.	Yes	MSA Declaration	For more information on MSA visit the MLA website.
Recipient Australian Business Number (ABN)	This is an 11-digit registration number, issued by the Australian Tax Office, used to identify businesses.	Yes	Feed and water record, Receipt of purchase/Tax Invoice	For more information visit the ATO website.
Seller/Supplier Australian Business Number (ABN)	This is an 11-digit registration number, issued by the Australian Tax Office, used to identify businesses.	Yes	Feed and water record, Receipt of purchase/Tax Invoice	For more information visit the ATO website.
To PIC	The Property Identification Code from/to where the livestock or product were consigned.	Yes	NLIS Movement Update, NVD, Post Sale Summary, State specific movement forms	For more information visit the Integrity systems website.
Transport registration number	The registration number of the vehicle in which the animals or product were transported. For shipments of product this will be a shipping container number.	Yes	NVD	
Treatment date	The date on which a treatment or product was applied to a unit e.g., paddock, animal, fodder etc.	Yes	Feed and water record, NVD	

5.2.2.1.3 Physical Outputs including Critical Tracking Events (CTEs)

The physical outputs from lairage include small stock suitable for processing, or in situations where animals are unfit for movement, they may be humanely slaughtered in lairage. In such instances, condemned carcasses may also be outputs.

Critical Tracking Events (CTEs) are defined as those events which include the growing, receiving, transforming, creating, and shipping of food products. Such events are critical to the traceability of product throughout the supply chain.

The CTEs associated with the outputs of the lairage system include the movement of:

- Small livestock
- Condemned carcase

off the property, premises, or supply chain sector.

Table 17. Physical outputs and associated Critical Tracking Event related documents for a small stock lairage system.

Event related to the inputs	Description of the inputs	Critical Tracking Event (CTE) related documents (including electronic)	More details
Small livestock	These are sheep or goat livestock and may include any class of animals e.g., weaners, ewe/nanny, ram/buck, cull livestock etc.	Commercial supply contract, Feed and water record, MSA Declaration, NLIS Movement Update, NVD, Post Sale Summary, Processing plant production management system, Receipt of purchase/Tax Invoice, State specific movement forms	
Condemned carcase	The body of a slaughtered animal deemed unfit for human consumption. This may be a condemned dressed carcase when hide/skin, head, feet, and offal are removed.	Commercial supply contract, Feed and water record, MSA Declaration, NLIS Movement Update, NVD, Post Sale Summary, Processing plant production management system, Receipt of purchase/Tax Invoice, State specific movement forms	

5.2.2.1.4 Information Outputs including Key Data Elements (KDEs)

Key Data Elements (KDEs) are defined as those elements which are key in identifying and tracing the Critical Tracking Event (CTE). Information outputs for lairage are those which are found on critical transfer documentation and the required documents for regulatory programs. This includes documents such as the NVD and MSA Declaration.

Table 18. Information outputs, Key Data Elements and Critical Tracking Event related documentation for a small stock lairage system.

Attributes (including KDEs)	Description of the Attributes (including KDEs)	Is a KDE	Critical Tracking Event (CTE) related documents (including electronic)	More details
Agreement date	This is the date on which an agreement between two parties was made.	Yes	Commercial supply contract, Processing plant production management system	
APVMA approval number	This is a unique number allocated to each label by the APVMA.	Yes	NVD, Processing plant production management system	For more information visit the Australian Pesticides and Veterinary Authority.
Batch number	This is a unique number which identifies products sharing certain production characteristics and is used for traceability purposes.	Yes	NVD, Processing plant production management system	
Company/product code	This is an in-house code for the identification of the product in the unit.	Yes	Processing plant production management system, Receipt of purchase/Tax Invoice	

Contract number	This is a unique number allocated to the contract by the seller.	Yes	Commercial supply contract, Processing plant production management system	
Date	This is the date of signing or of which a record entry or transaction was made.	Yes	Commercial supply contract, Feed and water record, MSA Declaration, NVD, Post Sale Summary, Processing plant production management system, Receipt of purchase/Tax Invoice, State specific movement forms	
From PIC	The Property Identification Code from/to where the livestock or product were consigned.	Yes	MSA Declaration, NLIS Movement Update, NVD, Post Sale Summary, Processing plant production management system, State specific movement forms	For more information visit the Integrity systems website.
Lot number	A lot is a number assigned by the processor to each group of small stock consigned to slaughter and is usually vendor specific.	Yes	Processing plant production management system	
Movement date	The date on which livestock or other products (e.g., feed or meat products) were transported between PICs/establishments.	Yes	Commercial supply contract, MSA Declaration, NLIS Movement Update, NVD, Processing plant production management system, State specific movement forms	
Movement time	This is the time at which livestock were moved from the property (PIC) of origin. Direct consignments travelling to processors by road must be slaughtered with 48 hours of dispatch.	Yes	MSA Declaration, Processing plant production management system	
MSA Declaration Serial Number	Each MSA Declaration form has a unique serial number.	Yes	MSA Declaration, Processing plant production management system	For more information on MSA visit the MLA website.
MSA Licence Number	Any establishment consigning, supplying, or identifying MSA Certified Product must be registered and have a unique MSA Licence Number.	Yes	MSA Declaration, Processing plant production management system, Receipt of purchase/Tax Invoice	For more information on MSA visit the MLA website.
NLIS Tag Number/RFID	All animals transported between PICs must have a permanent National Livestock Identification System tag attached. This tag has a unique animal identification number.	Yes	NLIS Movement Update, Processing plant production management system	For more information visit the Integrity systems website.
NVD Serial Number	Each NVD form has a unique serial number.	Yes	NLIS Movement Update, NVD, Post Sale Summary, Processing plant production management system	For more information visit the Integrity systems website.

Producer/Vendor MSA Registration Number	Producers consigning livestock to MSA markets are required to be registered and have a unique MSA Registration Number.	Yes	MSA Declaration, Processing plant production management system	For more information on MSA visit the MLA website.
Recipient Australian Business Number (ABN)	This is an 11-digit registration number, issued by the Australian Tax Office, used to identify businesses.	Yes	Feed and water record, Processing plant production management system, Receipt of purchase/Tax Invoice	For more information visit the ATO website.
Seller/Supplier Australian Business Number (ABN)	This is an 11-digit registration number, issued by the Australian Tax Office, used to identify businesses.	Yes	Feed and water record, Processing plant production management system, Receipt of purchase/Tax Invoice	For more information visit the ATO website.
To PIC	The Property Identification Code from/to where the livestock or product were consigned.	Yes	NLIS Movement Update, NVD, Post Sale Summary, Processing plant production management system, State specific movement forms	For more information visit the Integrity systems website.
Transport registration number	The registration number of the vehicle in which the animals or product were transported. For shipments of product this will be a shipping container number.	Yes	NVD, Processing plant production management system	
Treatment date	The date on which a treatment or product was applied to a unit e.g., paddock, animal, fodder etc.	Yes	Feed and water record, NVD, Processing plant production management system	

5.2.2.1.5 Regulatory and Industry Programs

- AUS-MEAT
- Australian Meat Industry Council (AMIC)
- Department of Agriculture
- eNVD
- Livestock Production Assurance (LPA)
- Meat Standards Australia (MSA)
- National Livestock Identification System (NLIS)
- Other data sources

5.2.2.1.6 Supply Chain Node Traceability

The National Livestock Identification System (NLIS) is the Australian livestock traceability program which is administered by Integrity Systems Company (ISC). Where stipulated by State legislation and certain export markets, the NLIS system requires all animals bought, sold, and moved along the supply chain to be tagged with an accredited NLIS ID tag. In some states, these tags require only the visual display of the Property Identification Code (PIC), while other states require each tag to have an individualised NLIS tag number or Radio Frequency Identifier (RFID) for the traceability of the animal throughout its lifetime. Every property which holds livestock must have a Property Identification Code (PIC) to which the livestock are assigned in the NLIS Database. Each time livestock are transferred between PICs within Australia they must be accompanied by a livestock movement declaration, such as the National Vendor Declaration (NVD) form. This document typically outlines the transporter details, consignment details, compliance with intended market specifications, withholding periods, and the details

of the new property PIC. All livestock movements between PICs require an NLIS movement update to be made by either or both the consigner and receiver. Where NLIS ID tags are lost livestock must be issued with a new post-breeder tag if not on the PIC of birth and this reconciled in the NLIS Database.

5.2.2.1.7 Data flow diagrams

Table 19. Data flow diagrams for the inputs and outputs of a small stock lairage system.

Direction	Description
Input	Feedlot to Lairage - over the hooks (direct consignment)
Input	Feedlot to Lairage - company owned
Input	Feedlot to Lairage - 3rd party kill or operator
Input	Saleyard to Lairage
Output	Lairage to Slaughter
Output	Lairage to Render - condemn or dead on arrival

5.2.2.1.7.1 Feedlot to Lairage - over the hooks (direct consignment)

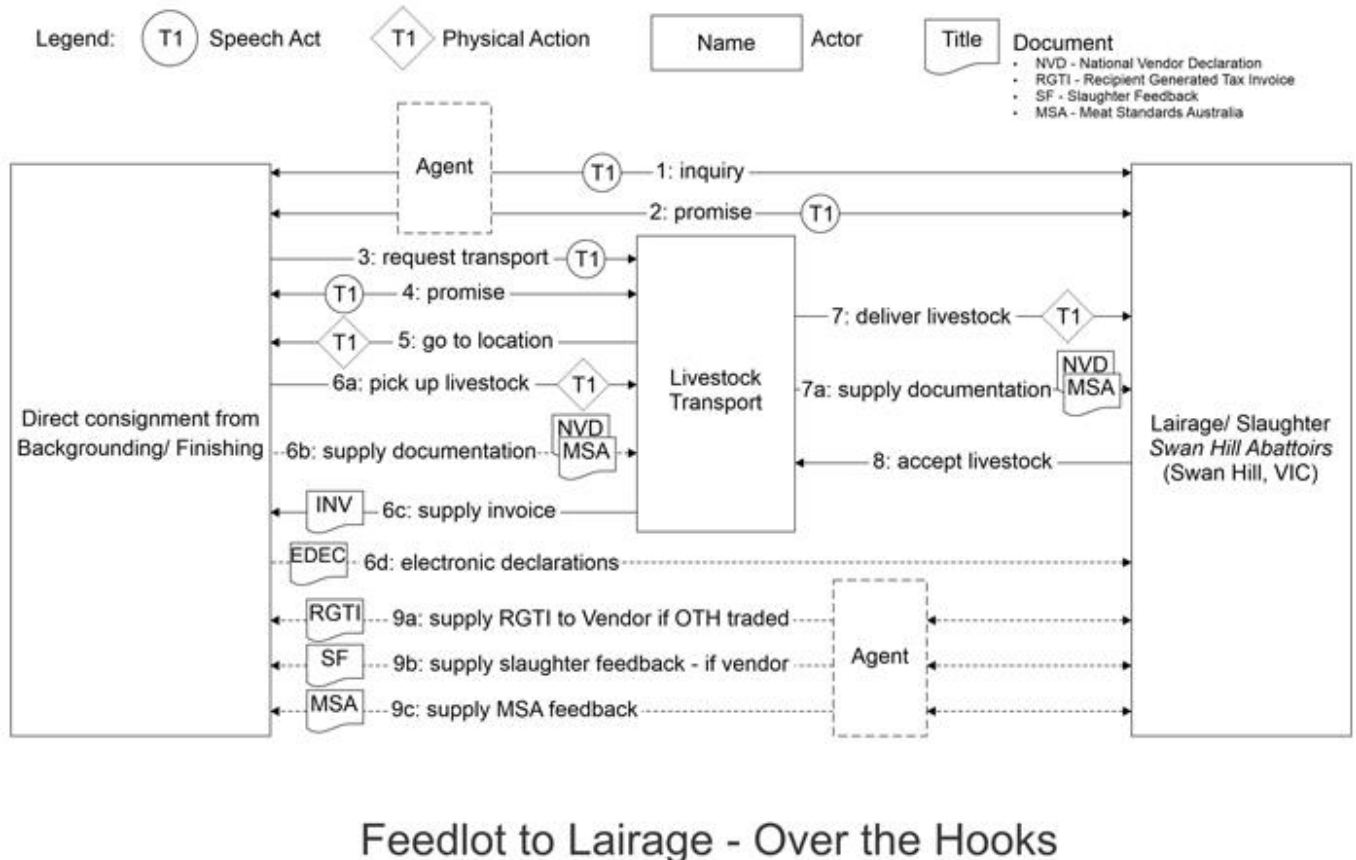

Feedlot to Lairage - Over the Hooks

Figure 19. Data or information flows from the feedlot to lairage (over the hooks) systems in the small stock supply chain.

5.2.2.1.7.2 Feedlot to Lairage - company owned

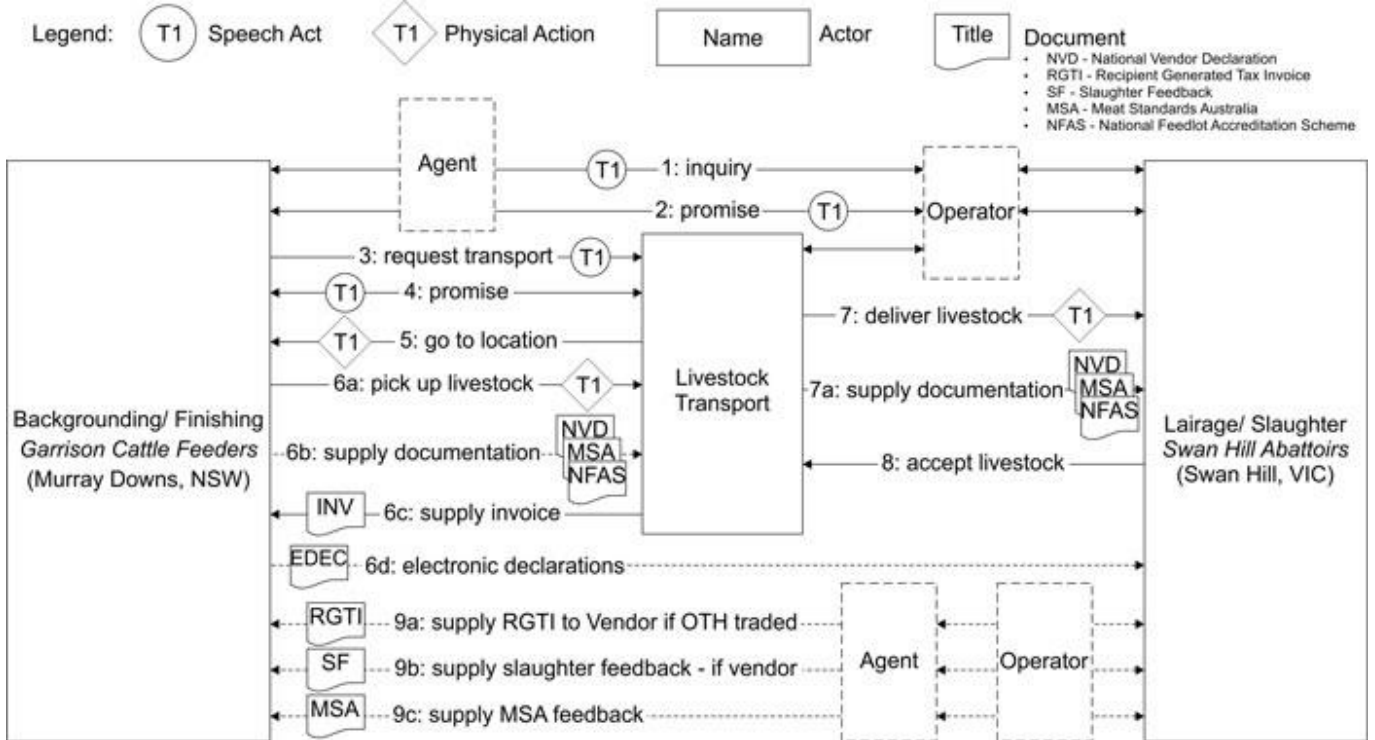

Figure 20. Data or information flows from the feedlot to lairage (company owned) systems in the small stock supply chain.

5.2.2.1.7.3 Feedlot to Lairage - 3rd party kill or operator

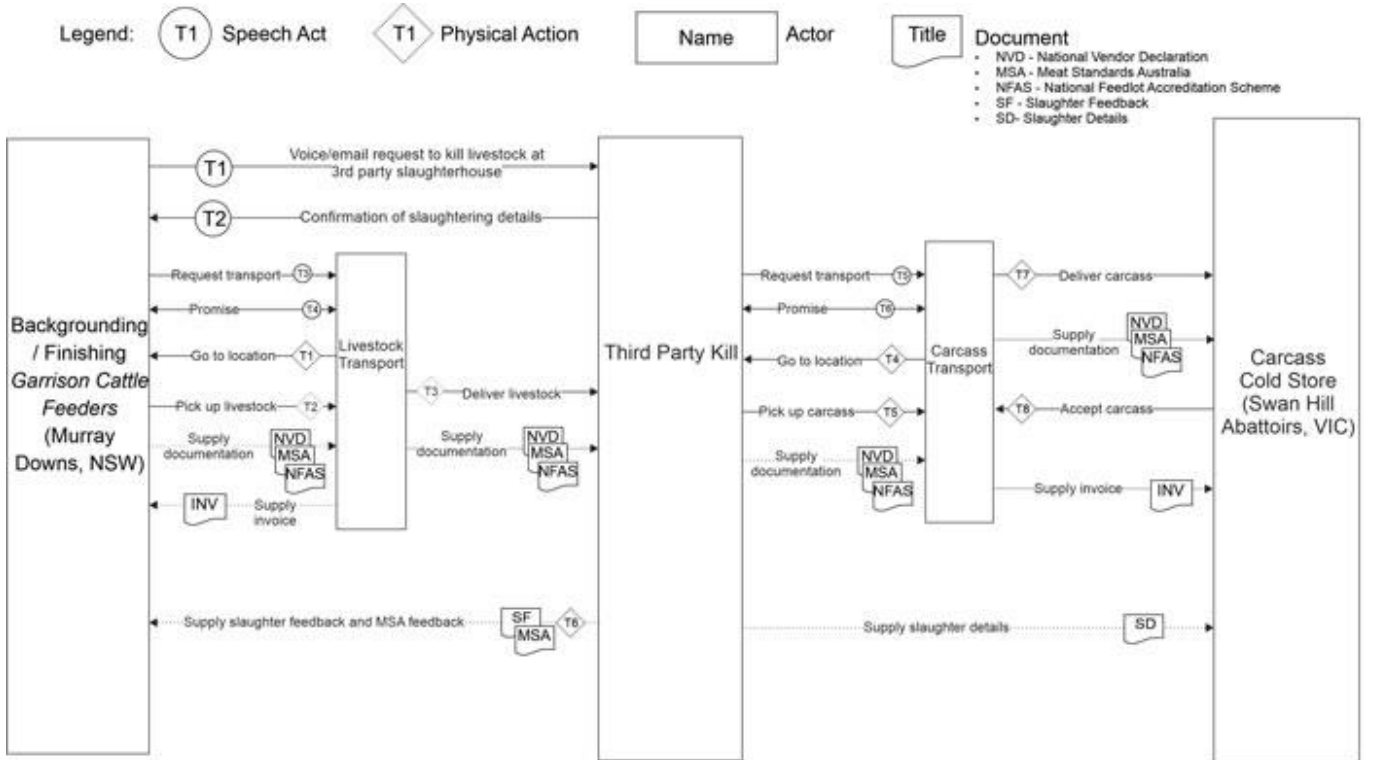
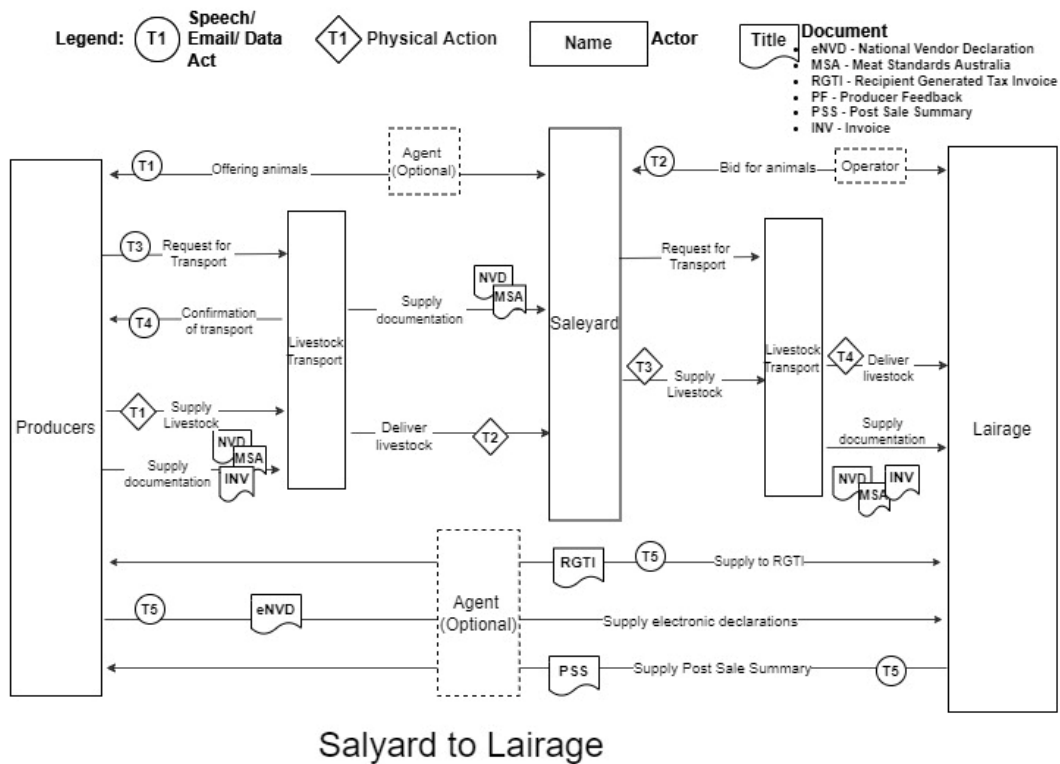

Figure 21. Data or information flows from the feedlot to lairage (3rd part kill or operator) systems in the small stock supply chain.

5.2.2.1.7.4 Saleyard to Lairage



Saleyard to Lairage

Figure 22. Data or information flows from the saleyard to lairage systems in the small stock supply chain.

5.2.2.1.7.5 Lairage to Slaughter

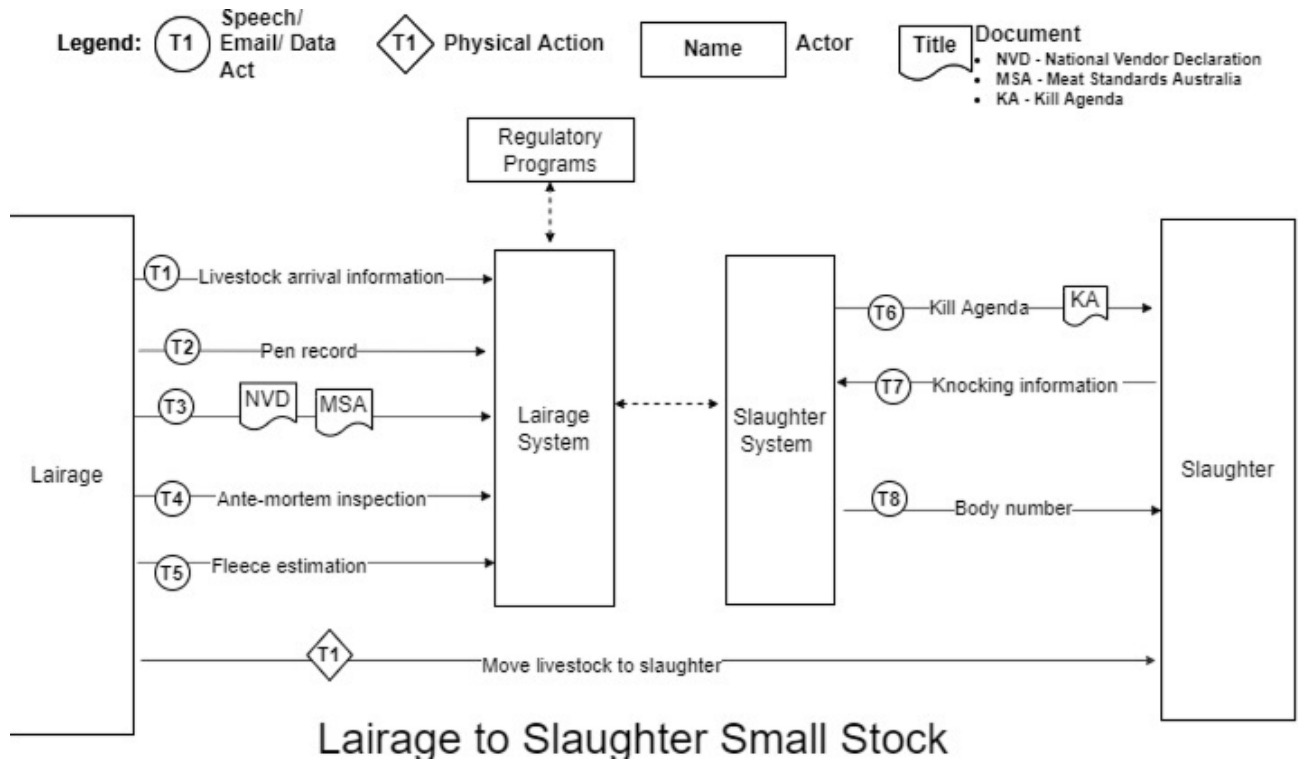

Lairage to Slaughter Small Stock

Figure 23. Data or information flows from the lairage to slaughter systems in the small stock supply chain.

5.2.2.1.7.6 Lairage to Render - condemn or dead on arrival

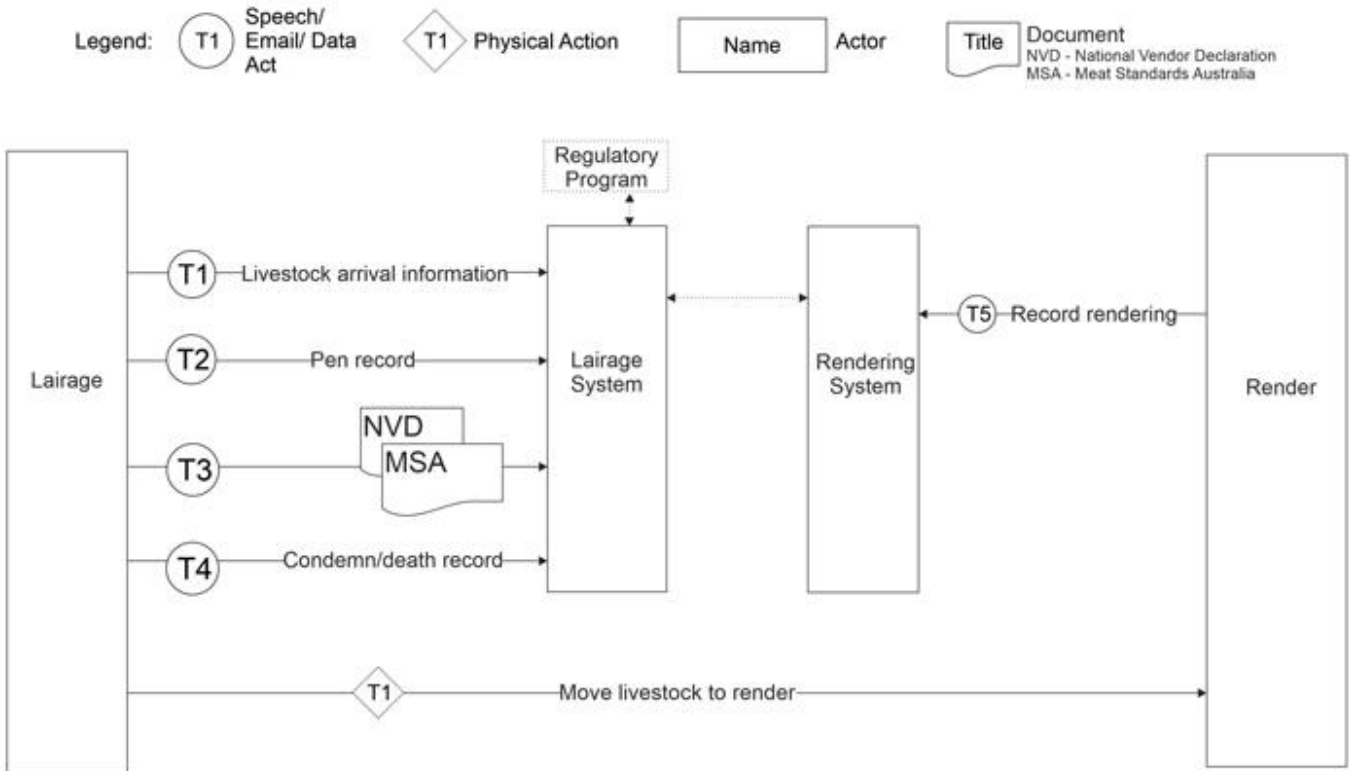

Lairage to Render - Condemns and Dead on arrival/ in pen

Figure 24. Data or information flows from the lairage to render (condemn or dead on

arrival) systems in the small stock supply chain.

5.2.2.2 Slaughter

Slaughter is the term which collectively describes a number of processes that begin with the slaughter of the live animal and end with a dressed carcass whereby the head, skin, legs, tail and viscera have been removed. These processes include the stunning, bleeding, evisceration, inspection, trimming, and ticketing of carcasses. Towards the end of the slaughter process, each carcass is issued a carcass ticket with a unique serialised identifier. This identifier allows the forward and backward traceability of the carcass through the value chain, being correlated to the live animal NLIS tag number and remaining with the carcass until it is boned into cartoned product and receives a serialised carton label.

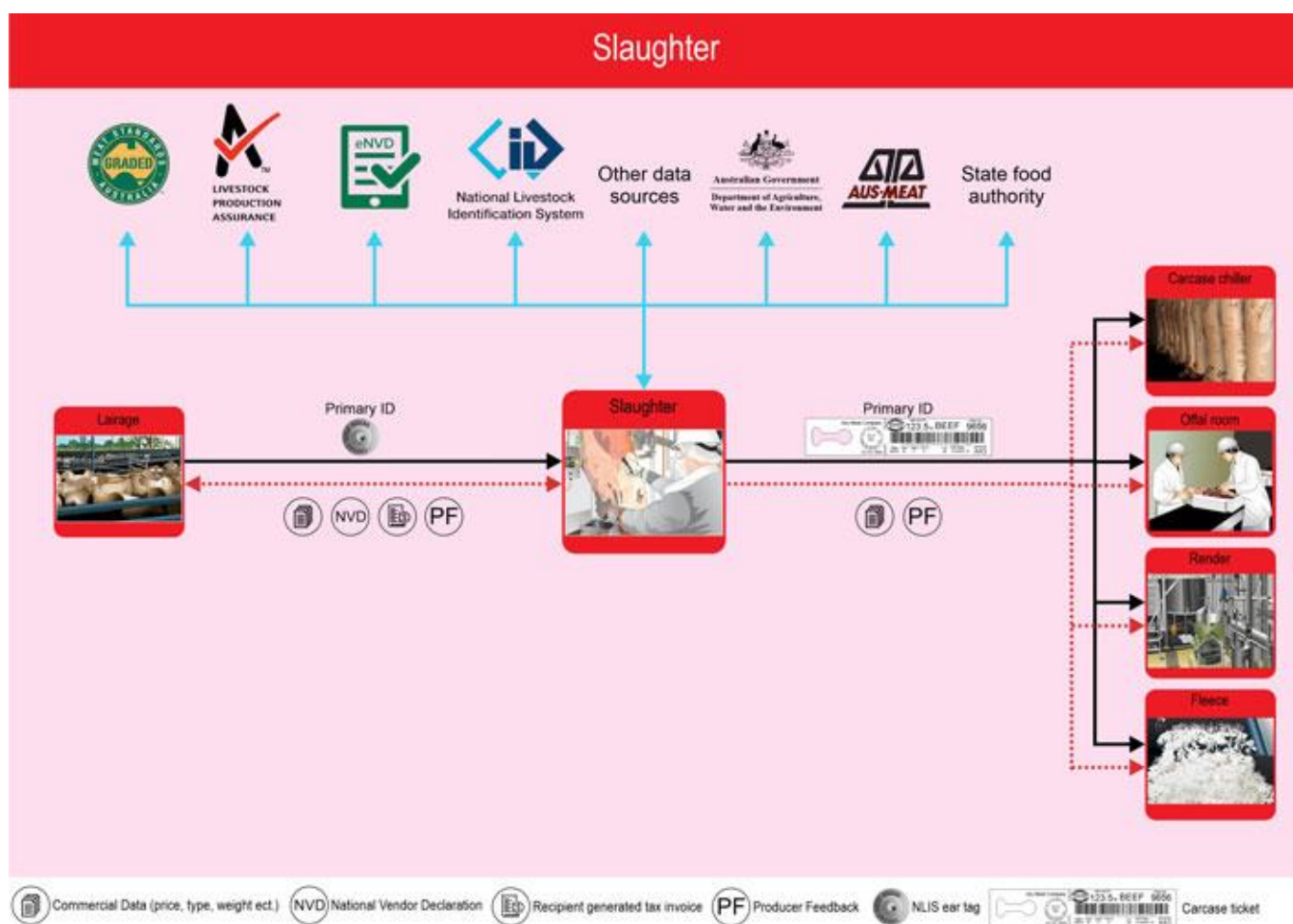

Figure 25. Inputs and outputs of the small stock supply chain slaughter sector.

5.2.2.2.1 Physical Inputs including Critical Tracking Events (CTEs)

The slaughter process is carefully done to ensure that the animal is killed correctly and humanely and to increase efficiency. Live animals from lairage, which have been passed for slaughter at ante mortem inspection by an Authorised Officer, are physical inputs into the slaughter system.

Critical Tracking Events (CTEs) are defined as those events which include the growing, receiving, transforming, creating, and shipping of food products. Such events are critical to the traceability of product throughout the supply chain.

The CTEs associated with inputs to the slaughter system include the receipt of:

- Small livestock.

Table 20. Physical inputs and associated Critical Tracking Event related documents for a small stock slaughter system.

Event related to the inputs	Description of the inputs	Critical Tracking Event (CTE) related documents (including electronic)	More details
Small livestock	These are sheep or goat livestock and may include any class of animals e.g., weaners,	Commercial supply contract, Feed and water record, MSA Declaration, NLIS Movement Update, NVD, Post Sale Summary, Processing plant production management	

	ewe/nanny, ram/buck, cull livestock etc.	system, Receipt of purchase/Tax Invoice, State specific movement forms	
--	--	--	--

5.2.2.2.2 Information Inputs including Key Data Elements (KDEs)

Key Data Elements (KDEs) are defined as those elements which are key in identifying and tracing the Critical Tracking Event (CTE). Information inputs for slaughter are those which are carried through from lairage and associated with critical movement documentation.

Table 21. Information inputs, Key Data Elements and Critical Tracking Event related documentation for a small stock slaughter system.

Attributes (including KDEs)	Description of the Attributes (including KDEs)	Is a KDE	Critical Tracking Event (CTE) related documents (including electronic)	More details
Agreement date	This is the date on which an agreement between two parties was made.	Yes	Commercial supply contract, Processing plant production management system	
APVMA approval number	This is a unique number allocated to each label by the APVMA.	Yes	NVD, Processing plant production management system	For more information visit the Australian Pesticides and Veterinary Medicine Authority.
Batch number	This is a unique number which identifies products sharing certain production characteristics and is used for traceability purposes.	Yes	NVD, Processing plant production management system	
Company/product code	This is an in-house code for the identification of the product in the unit.	Yes	Processing plant production management system, Receipt of purchase/Tax Invoice	
Contract number	This is a unique number allocated to the contract by the seller.	Yes	Commercial supply contract, Processing plant production management system	
Date	This is the date of signing or of which a record entry or transaction was made.	Yes	Commercial supply contract, Feed and water record, MSA Declaration, NVD, Post Sale Summary, Processing plant production management system, Receipt of purchase/Tax Invoice, State specific movement forms	
From PIC	The Property Identification Code from/to where the livestock or product were consigned.	Yes	MSA Declaration, NLIS Movement Update, NVD, Post Sale Summary, Processing plant production management system, State specific movement forms	For more information visit the Integrity systems website.
Lot number	A lot is a number assigned by the processor to each group of livestock consigned to slaughter and is usually vendor specific.	Yes	Processing plant production management system	
Movement date	The date on which livestock or other products (e.g., feed or	Yes	Commercial supply contract, MSA Declaration, NLIS Movement	

	meat products) were transported between PICs/establishments.		Update, NVD, Processing plant production management system, State specific movement forms	
Movement time	This is the time at which livestock were moved from the property (PIC) of origin. Direct consignments travelling to processors by road must be slaughtered with 48 hours of dispatch.	Yes	MSA Declaration, Processing plant production management system	
MSA Declaration Serial Number	Each MSA Declaration form has a unique serial number.	Yes	MSA Declaration, Processing plant production management system	For more information on MSA visit the MLA website.
MSA Licence Number	Any establishment consigning, supplying, or identifying MSA Certified Product must be registered and have a unique MSA Licence Number.	Yes	MSA Declaration, Processing plant production management system, Receipt of purchase/Tax Invoice	For more information on MSA visit the MLA website.
NLIS Tag Number/RFID	All animals transported between PICs must have a permanent National Livestock Identification System tag attached. This tag has a unique animal identification number.	Yes	NLIS Movement Update, Processing plant production management system	For more information visit the Integrity systems website.
NVD Serial Number	Each NVD form has a unique serial number.	Yes	NLIS Movement Update, NVD, Post Sale Summary, Processing plant production management system	For more information visit the Integrity systems website.
Producer/Vendor MSA Registration Number	Producers consigning livestock to MSA markets are required to be registered and have a unique MSA Registration Number.	Yes	MSA Declaration, Processing plant production management system	For more information on MSA visit the MLA website.
Recipient Australian Business Number (ABN)	This is an 11-digit registration number, issued by the Australian Tax Office, used to identify businesses.	Yes	Feed and water record, Processing plant production management system, Receipt of purchase/Tax Invoice	For more information visit the ATO website.
Seller/Supplier Australian Business Number (ABN)	This is an 11-digit registration number, issued by the Australian Tax Office, used to identify businesses.	Yes	Feed and water record, Processing plant production management system, Receipt of purchase/Tax Invoice	For more information visit the ATO website.
To PIC	The Property Identification Code from/to where the livestock or product were consigned.	Yes	NLIS Movement Update, NVD, Post Sale Summary, Processing plant production management system, State specific movement forms	For more information visit the Integrity systems website.
Transport registration number	The registration number of the vehicle in which the animals or product were transported. For shipments of product this will be a shipping container number.	Yes	NVD, Processing plant production management system	
Treatment date	The date on which a treatment or product was applied to a unit	Yes	Feed and water record, NVD, Processing plant production management system	

	e.g., paddock, animal, fodder etc.			
--	------------------------------------	--	--	--

5.2.2.2.3 Physical Outputs including Critical Tracking Events (CTEs)

The physical outputs from the slaughter process include carcasses and offal passed by Authorised Officers for human consumption, as well as condemned carcasses, carcass parts and offal. This product cannot be processed and sold for human consumption.

Critical Tracking Events (CTEs) are defined as those events which include the growing, receiving, transforming, creating, and shipping of food products. Such events are critical to the traceability of product throughout the supply chain.

The CTEs associated with the outputs of the slaughter system include the movement of:

- Carcass
- Condemned carcass
- Condemned carcass parts
- Condemned offal
- Hide/Skin
- Offal

off the property, premises, or supply chain sector.

Table 22. Physical outputs and associated Critical Tracking Event related documents for a small stock slaughter system.

Event related to the inputs	Description of the inputs	Critical Tracking Event (CTE) related documents (including electronic)	More details
Carcass	The body of a slaughtered animal after bleeding. Becomes a dressed carcass when hide/skin, head, feet, and offal are removed.	Carcass Ticket, MSA Data Capture Unit/myMSA, NLIS Movement Update, Processing plant production management system	
Condemned carcass	The body of a slaughtered animal deemed unfit for human consumption. This may be a condemned dressed carcass when hide/skin, head, feet, and offal are removed.	Carcass Ticket, Processing plant production management system	
Condemned carcass parts	Any tissue or structure removed from a slaughtered animal deemed unfit for human consumption. These parts may include the head, viscera, offal, musculature, and blood. Note condemned offal is treated as a separate item here.	Processing plant production management system	
Condemned offal	Offal tissues deemed unfit for human consumption.	Processing plant production management system	
Hide/Skin	The pelt of the animal. Typically referred to as 'hide' for larger animals e.g., cattle and 'skin' for smaller animals e.g., sheep, calves.	Processing plant production management system	
Offal	The organs of the thoracic and abdominal cavities, the brain, the muscular tissues of the head and diaphragm, the tail, feet, or tendons.	Processing plant production management system	

5.2.2.2.4 Information Outputs including Key Data Elements (KDEs)

Key Data Elements (KDEs) are defined as those elements which are key in identifying and tracing the Critical Tracking Event (CTE). Information outputs from slaughter are derived principally from carcass tickets which include regulated information for traceability purposes. This information is linked to that received in lairage through the processing production management system.

Table 23. Information outputs, Key Data Elements and Critical Tracking Event related documentation for a small stock slaughter system.

Attributes (including KDEs)	Description of the Attributes (including KDEs)	Is a KDE	Critical Tracking Event (CTE) related documents (including electronic)	More details
Batch number	This is a unique number which identifies products sharing certain production characteristics and is used for traceability purposes.	Yes	Carcass Ticket, Processing plant production management system	
From Establishment number	A number issued by Federal and State Authorities to identify the originating site from which meat or meat products were distributed to domestic or export markets. For transfer certificates, the Establishment numbers for both the dispatching and receiving establishments are recorded.	Yes	Carcass Ticket, Processing plant production management system	
From PIC	The Property Identification Code from/to where the livestock or product were consigned.	Yes	NLIS Movement Update, Processing plant production management system	For more information visit the Integrity systems website.
Global Trade Item Number (GTIN)	Encoded in the GS1 barcode, the GTIN is a globally unique 14-digit number used to identify trade items, products, or services.	Yes	Carcass Ticket, Processing plant production management system	For more information visit the GS1 website.
Lot number	A lot is a number assigned by the processor to each group of small stock consigned to slaughter and is usually vendor specific.	Yes	Carcass Ticket, MSA Data Capture Unit/myMSA, Processing plant production management system	
Movement date	The date on which livestock or other products (e.g., feed or meat products) were transported between PICs/establishments.	Yes	NLIS Movement Update, Processing plant production management system	
MSA Declaration Serial Number	Each MSA Declaration form has a unique serial number.	Yes	MSA Data Capture Unit/myMSA, Processing plant	For more information on MSA

			production management system	visit the MLA website.
MSA Licence Number	Any establishment consigning, supplying, or identifying MSA Certified Product must be registered and have a unique MSA Licence Number.	Yes	MSA Data Capture Unit/myMSA, Processing plant production management system	For more information on MSA visit the MLA website.
Net Weight (Kilograms)	Usually encoded in the GS1 barcode, the Net Weight is a variable measure of the trade item e.g., carton, pallet or shipment recorded in kilograms.	Yes	Carcase Ticket, Processing plant production management system	For more information visit the GS1 website.
NLIS Tag Number/RFID	All animals transported between PICs must have a permanent National Livestock Identification System tag attached. This tag has a unique animal identification number.	Yes	MSA Data Capture Unit/myMSA, NLIS Movement Update, Processing plant production management system	For more information visit the Integrity systems website.
NVD Serial Number	Each NVD form has a unique serial number.	Yes	NLIS Movement Update, Processing plant production management system	For more information visit the Integrity systems website.
Official mark	Any stamp, seal, label, or mark that is declared by the regulations to be an official mark. An official mark signifies that the product has been inspected by and approved as safe for human consumption by an Authorised Officer.	Yes	Carcase Ticket	
Producer/Vendor MSA Registration Number	Producers consigning livestock to MSA markets are required to be registered and have a unique MSA Registration Number.	Yes	MSA Data Capture Unit/myMSA, Processing plant production management system	For more information on MSA visit the MLA website.
Production Date (YYMMDD)	Encoded in the GS1 barcode, this is the 'kill' or slaughter' date of the product and is recorded in the format year, month, day (YYMMDD).	Yes	Carcase Ticket, Processing plant production management system	For more information visit the GS1 website.
Serial Number	Encoded in the GS1 barcode, this is a code, numeric or alphanumeric, assigned to an individual instance of an item for its lifetime.	Yes	Carcase Ticket, Processing plant production management system	For more information visit the GS1 website.
Slaughter or processing date	This is the date on which livestock were slaughtered by the processor or the day on which carcasses were processed (if different to slaughter date).	Yes	MSA Data Capture Unit/myMSA, NLIS Movement Update, Processing plant production	

			management system	
To PIC	The Property Identification Code from/to where the livestock or product were consigned.	Yes	NLIS Movement Update, Processing plant production management system	For more information visit the Integrity systems website.
Trade description	This is a collective set of words that says what the product is and may include information such as species, net weight of product, name and address of establishments, category ciphers, market endorsements, MSA eating quality etc.	Yes	Carcase Ticket, Processing plant production management system	

5.2.2.2.5 Regulatory and Industry Programs

- AUS-MEAT
- Australian Meat Industry Council (AMIC)
- Department of Agriculture
- eNVD
- Livestock Production Assurance (LPA)
- Meat Standards Australia (MSA)
- National Livestock Identification System (NLIS)
- State food authority
- Other data sources

5.2.2.2.6 Supply Chain Node Traceability

The National Livestock Identification System (NLIS) is the Australian livestock traceability program which is administered by Integrity Systems Company (ISC). Where stipulated by State legislation and certain export markets, the NLIS system requires all animals bought, sold and, moved along the supply chain to be tagged with an accredited NLIS ID tag. In some states, these tags require only the visual display of the Property Identification Code (PIC), while other states require each tag to have an individualised NLIS tag number or Radio Frequency Identifier (RFID) for the traceability of the animal throughout its lifetime. Every property which holds livestock must have a Property Identification Code (PIC) to which the livestock are assigned in the NLIS Database. Each time livestock are transferred between PICs within Australia they must be accompanied by a livestock movement declaration, such as the National Vendor Declaration (NVD) form. This document typically outlines the transporter details, consignment details, compliance with intended market specifications, withholding periods, and the details of the new property PIC. All livestock movements between PICs require an NLIS movement update to be made by either or both the consigner and receiver. Where NLIS ID tags are lost livestock must be issued with a new post-breeder tag if not on the PIC of birth and this reconciled in the NLIS Database. Once animals are slaughtered, carcasses are issued with a carcass ticket which contains key information correlating with the PIC, NLIS tag number or RFID. This key information, including GS1 meat industry barcode, body number, processing establishment number and production date or 'kill date' must be uploaded to the NLIS Database.

5.2.2.2.7 Data flow diagrams

Table 24. Data flow diagrams for the inputs and outputs of a small stock slaughter system.

Direction	Description
Input	Lairage to Slaughter
Output	Slaughter to Render - full condemn, hides, partial condemn
Output	Slaughter to Offal room
Output	Slaughter to Chiller

5.2.2.2.7.1 Lairage to Slaughter

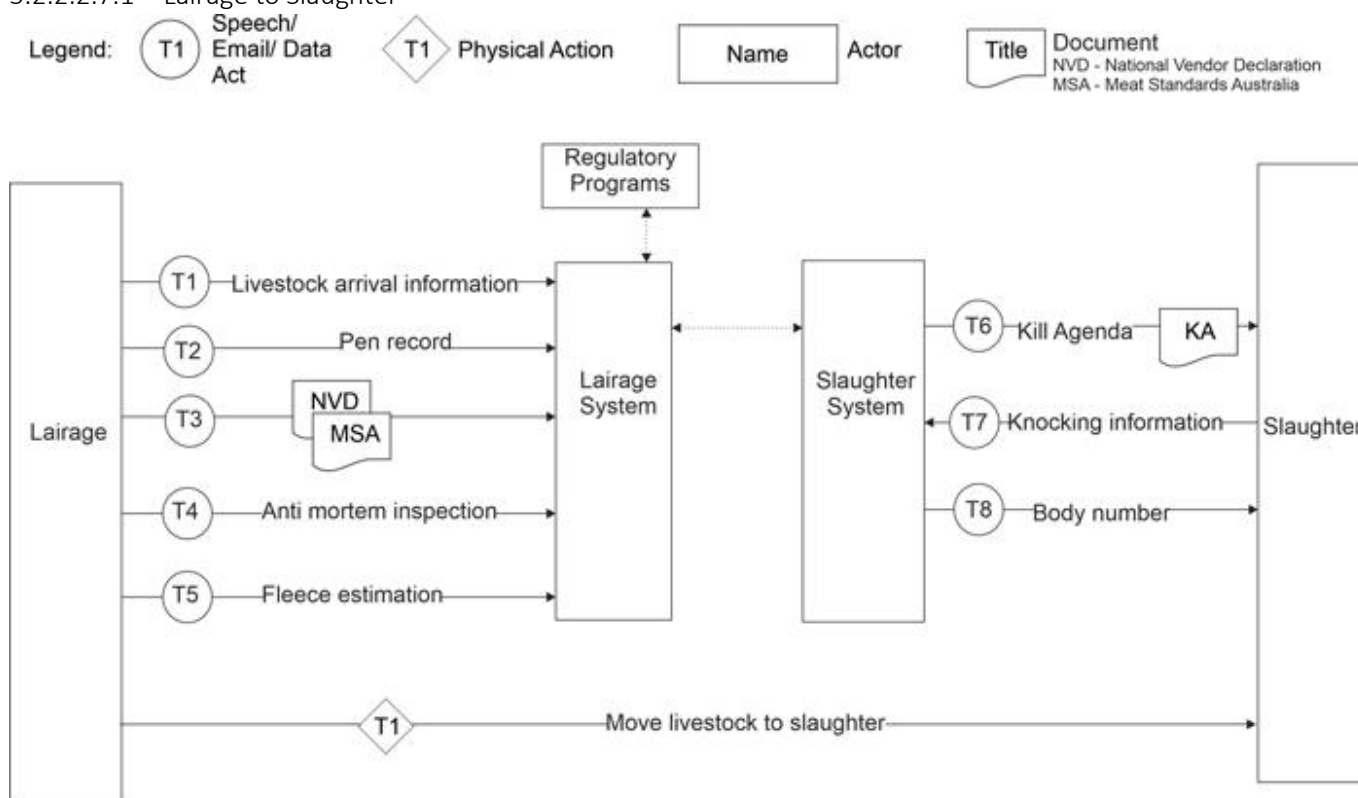

Lairage to Slaughter Small Stock

Figure 26. Data or information flows from the lairage to slaughter systems in the small stock supply chain.

5.2.2.2.7.2 Slaughter to Render – full condemn, hides, partial condemn

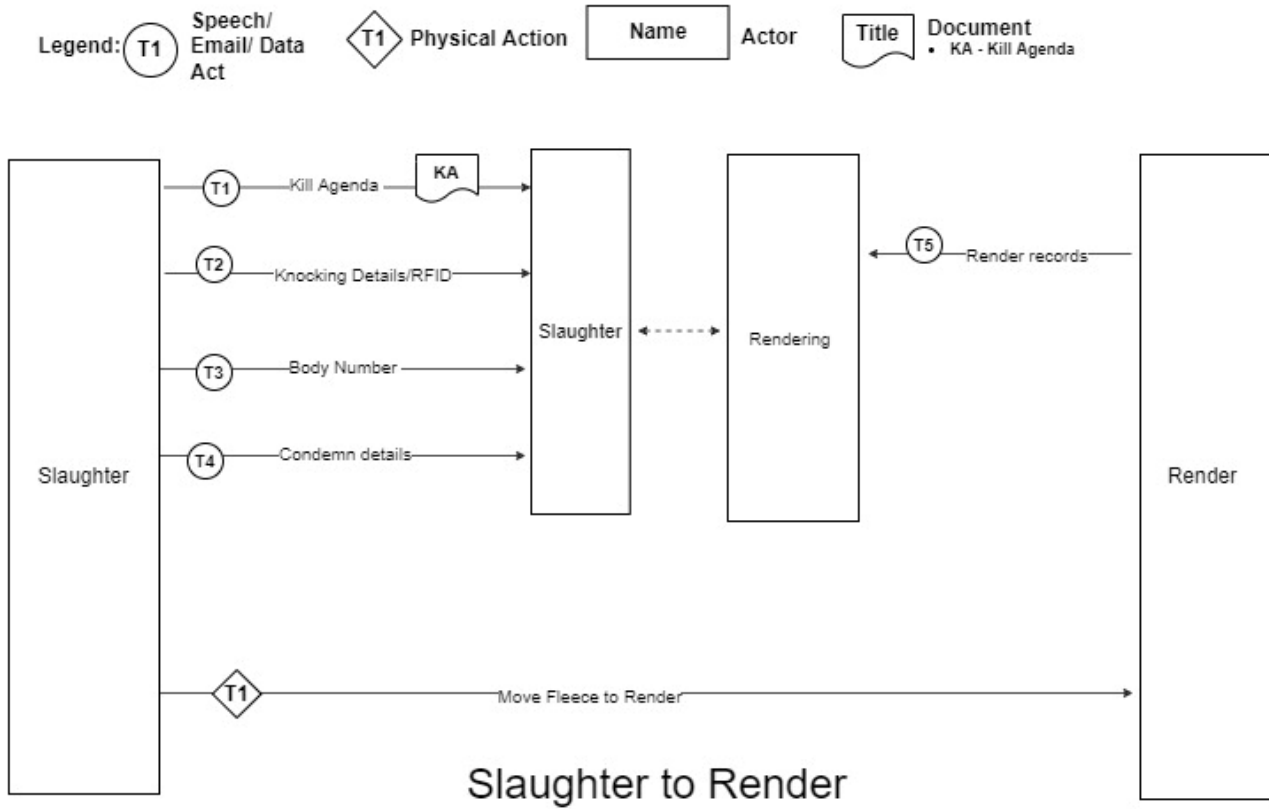

Figure 27. Data or information flows from the slaughter to render (full condemn, hides, partial condemn) systems in the small stock supply chain.

5.2.2.2.7.3 Slaughter to Offal room

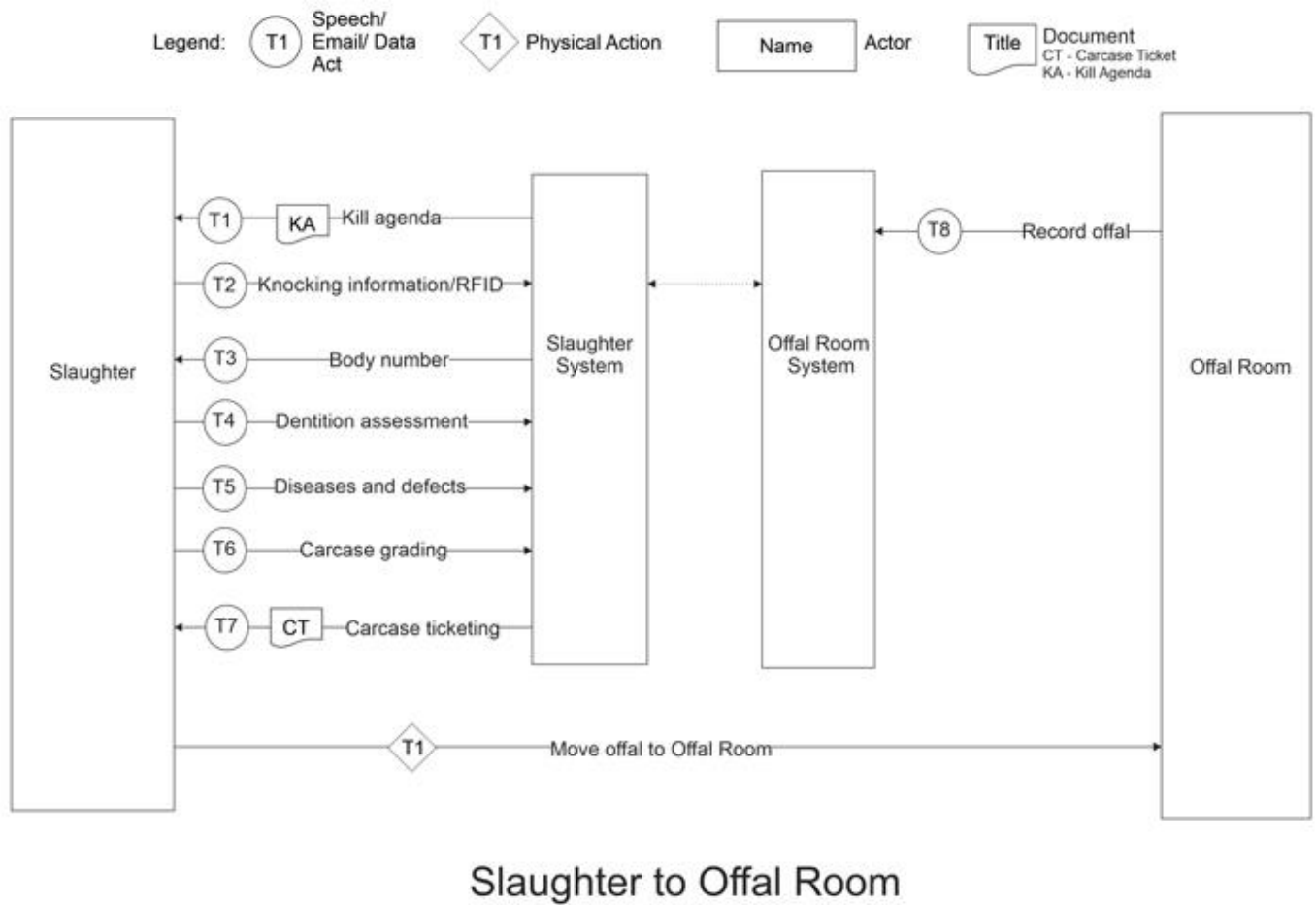

Figure 28. Data or information flows from the slaughter to offal room systems in the small stock supply chain.

5.2.2.2.7.4 Slaughter to Chiller

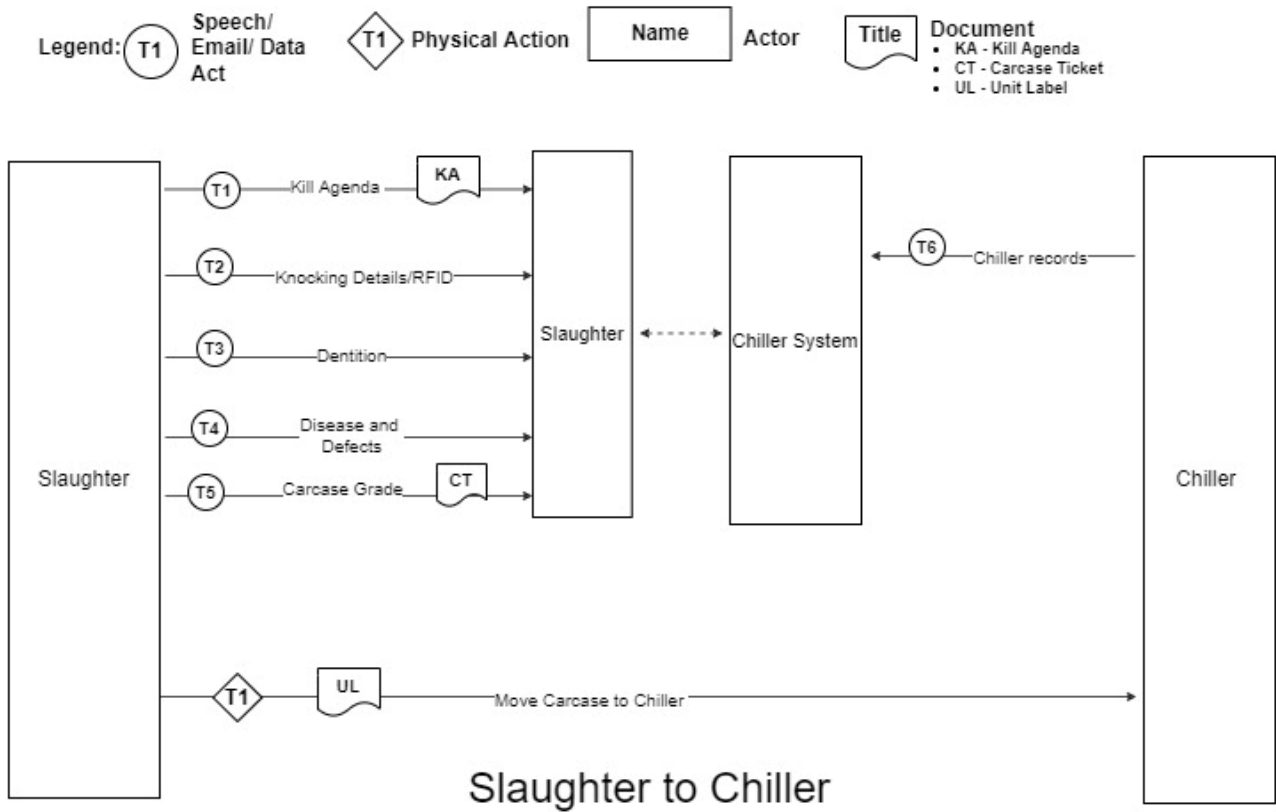

Figure 29. Data or information flows from the slaughter to chiller systems in the small stock supply chain.

5.2.2.3 Carcase chiller

Once the slaughter process is complete, carcasses are transferred into the carcase chiller in order to maintain and ensure product wholesomeness (safe to eat and aesthetically pleasing). The Australian standard requires all carcasses to be placed under refrigeration conditions for chilling or freezing within two hours of slaughter. Carcasses must be chilled to no more than 7 degrees Celsius within a period of 24 hours. Additionally, it is essential that hot carcasses do not enter the same carcase chiller containing already chilled product. This is to ensure meat safety.

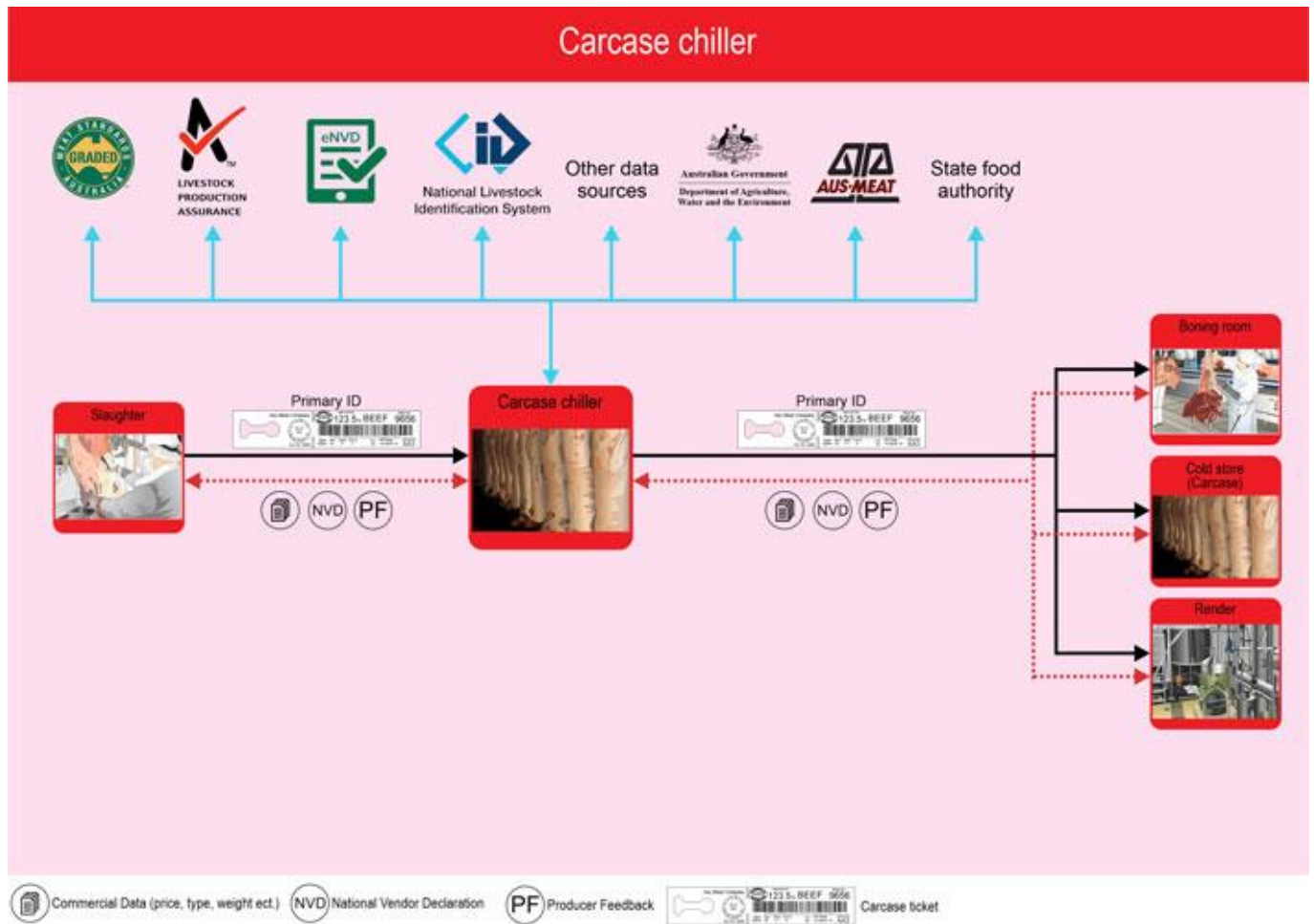

Figure 30. Inputs and outputs of the small stock supply chain carcass chiller sector.

5.2.2.3.1 Physical Inputs including Critical Tracking Events (CTEs)

The physical inputs for carcass chillers include the carcasses themselves with the Critical Tracking Event related documents including those which include important traceability information such as the carcass ticket.

Critical Tracking Events (CTEs) are defined as those events which include the growing, receiving, transforming, creating, and shipping of food products. Such events are critical to the traceability of product throughout the supply chain.

The CTEs associated with inputs to the carcass chiller system include the receipt of:

- Carcass.

Table 25. Physical inputs and associated Critical Tracking Event related documents for a small stock carcass chiller system.

Event related to the inputs	Description of the inputs	Critical Tracking Event (CTE) related documents (including electronic)	More details
Carcass	The body of a slaughtered animal after bleeding. Becomes a dressed carcass when hide/skin, head, feet, and offal are removed.	Carcass Ticket, MSA Data Capture Unit/myMSA, Processing plant production management system	

5.2.2.3.2 Information Inputs including Key Data Elements (KDEs)

Key Data Elements (KDEs) are defined as those elements which are key in identifying and tracing the Critical Tracking Event (CTE). There are a number of information inputs associated with the movement of carcasses into the carcass chiller system. These are largely included on the carcass ticket and are Key Data Elements encapsulated by the GS1 barcode, as well as other information required by federal legislation.

Table 26. Information inputs, Key Data Elements and Critical Tracking Event related documentation for a small stock carcass chiller system.

Attributes (including KDEs)	Description of the Attributes (including KDEs)	Is a KDE	Critical Tracking Event (CTE) related documents (including electronic)	More details
Body number	This is a number assigned to each carcass by the processor for identification purposes.	Yes	Carcass Ticket, MSA Data Capture Unit/myMSA, Processing plant production management system	
From Establishment number	A number issued by Federal and State Authorities to identify the originating site from which meat or meat products were distributed to domestic or export markets. For transfer certificates, the Establishment numbers for both the dispatching and receiving establishments are recorded.	Yes	Carcass Ticket, Processing plant production management system	
Global Trade Item Number (GTIN)	Encoded in the GS1 barcode, the GTIN is a globally unique 14-digit number used to identify trade items, products, or services.	Yes	Carcass Ticket, Processing plant production management system	For more information visit the GS1 website.
Lot number	A lot is a number assigned by the processor to each group of livestock consigned to slaughter and is usually vendor specific.	Yes	MSA Data Capture Unit/myMSA, Processing plant production management system	
MSA Declaration Serial Number	Each MSA Declaration form has a unique serial number.	Yes	MSA Data Capture Unit/myMSA, Processing plant production	For more information on MSA visit the MLA website.

			management system	
MSA Licence Number	Any establishment consigning, supplying, or identifying MSA Certified Product must be registered and have a unique MSA Licence Number.	Yes	MSA Data Capture Unit/myMSA, Processing plant production management system	For more information on MSA visit the MLA website.
Net Weight (Kilograms)	Usually encoded in the GS1 barcode, the Net Weight is a variable measure of the trade item e.g., carton, pallet or shipment recorded in kilograms.	Yes	Carcase Ticket, Processing plant production management system	For more information visit the GS1 website.
NLIS Tag Number/RFID	All animals transported between PICs must have a permanent National Livestock Identification System tag attached. This tag has a unique animal identification number.	Yes	MSA Data Capture Unit/myMSA, Processing plant production management system	For more information visit the Integrity systems website.
Official mark	Any stamp, seal, label, or mark that is declared by the regulations to be an official mark. An official mark signifies that the product has been inspected by and approved as safe for human consumption by an Authorised Officer.	Yes	Carcase Ticket	
Producer/Vendor MSA Registration Number	Producers consigning livestock to MSA markets are required to be registered and have a unique MSA Registration Number.	Yes	MSA Data Capture Unit/myMSA, Processing plant production management system	For more information on MSA visit the MLA website.
Production Date (YYMMDD)	Encoded in the GS1 barcode, this is the 'kill' or slaughter' date of the product and is recorded in the format year, month, day (YYMMDD).	Yes	Carcase Ticket, Processing plant production management system	For more information visit the GS1 website.
Serial Number	Encoded in the GS1 barcode, this is a code, numeric or alphanumeric, assigned to an individual instance of an item for its lifetime.	Yes	Carcase Ticket, Processing plant production management system	For more information visit the GS1 website.
Slaughter or processing date	This is the date on which livestock were slaughtered by the processor or the day on which carcasses were processed (if different to slaughter date).	Yes	MSA Data Capture Unit/myMSA, Processing plant production management system	
Trade description	This is a collective set of words that says what the product is and may include information such as species, net weight of product, name and address of establishments, category ciphers, market endorsements, MSA eating quality etc.	Yes	Carcase Ticket, Processing plant production management system	

5.2.2.3.3 Physical Outputs including Critical Tracking Events (CTEs)

The physical outputs of the carcass chiller system include carcasses passed as safe for human consumption as well as any carcasses previously identified as requiring a further disposition and deemed unfit for consumption (condemned carcasses).

Critical Tracking Events (CTEs) are defined as those events which include the growing, receiving, transforming, creating, and shipping of food products. Such events are critical to the traceability of product throughout the supply chain.

The CTEs associated with the outputs of the carcass chiller system include the movement of:

- Carcass
- Condemned carcass

off the property, premises, or supply chain sector.

Table 27. Physical outputs and associated Critical Tracking Event related documents for a small stock carcass chiller system.

Event related to the inputs	Description of the inputs	Critical Tracking Event (CTE) related documents (including electronic)	More details
Carcass	The body of a slaughtered animal after bleeding. Becomes a dressed carcass when hide/skin, head, feet, and offal are removed.	Carcass Ticket, MSA Carcass Ticket, MSA Data Capture Unit/myMSA, Processing plant production management system	
Condemned carcass	The body of a slaughtered animal deemed unfit for human consumption. This may be a condemned dressed carcass when hide/skin, head, feet, and offal are removed.	Carcass Ticket, Processing plant production management system	

5.2.2.3.4 Information Outputs including Key Data Elements (KDEs)

Key Data Elements (KDEs) are defined as those elements which are key in identifying and tracing the Critical Tracking Event (CTE). The information outputs relating to the movement of carcasses out of the chiller system is largely the same as for the movement of carcasses into the chiller system. This information can predominantly be found on the carcass ticket and will be stored in the processing plants production management system.

Table 28. Information outputs, Key Data Elements and Critical Tracking Event related documentation for a small stock carcass chiller system.

Attributes (including KDEs)	Description of the Attributes (including KDEs)	Is a KDE	Critical Tracking Event (CTE) related documents (including electronic)	More details
Body number	This is a number assigned to each carcass by the processor for identification purposes.	Yes	Carcass Ticket, MSA Data Capture Unit/myMSA, Processing plant production management system	

From Establishment number	A number issued by Federal and State Authorities to identify the originating site from which meat or meat products were distributed to domestic or export markets. For transfer certificates, the Establishment numbers for both the dispatching and receiving establishments are recorded.	Yes	Carcase Ticket, Processing plant production management system	
Global Trade Item Number (GTIN)	Encoded in the GS1 barcode, the GTIN is a globally unique 14-digit number used to identify trade items, products, or services.	Yes	Carcase Ticket, Processing plant production management system	For more information visit the GS1 website.
Lot number	A lot is a number assigned by the processor to each group of livestock consigned to slaughter and is usually vendor specific.	Yes	MSA Data Capture Unit/myMSA, Processing plant production management system	
MSA Declaration Serial Number	Each MSA Declaration form has a unique serial number.	Yes	MSA Data Capture Unit/myMSA, Processing plant production management system	For more information on MSA visit the MLA website.
MSA Licence Number	Any establishment consigning, supplying, or identifying MSA Certified Product must be registered and have a unique MSA Licence Number.	Yes	MSA Data Capture Unit/myMSA, Processing plant production management system	For more information on MSA visit the MLA website.
Net Weight (Kilograms)	Usually encoded in the GS1 barcode, the Net Weight is a variable measure of the trade item e.g., carton, pallet or shipment recorded in kilograms.	Yes	Carcase Ticket, Processing plant production management system	For more information visit the GS1 website.
NLIS Tag Number/RFID	All animals transported between PICs must have a permanent National Livestock Identification System tag attached. This tag has a unique animal identification number.	Yes	MSA Data Capture Unit/myMSA, Processing plant production management system	For more information visit the Integrity systems website.
Official mark	Any stamp, seal, label, or mark that is declared by the regulations to be an official mark. An official mark signifies that the product has been inspected by and approved as safe for human consumption by an Authorised Officer.	Yes	Carcase Ticket	
Producer/Vendor MSA Registration Number	Producers consigning livestock to MSA markets are required to be registered and have a unique MSA Registration Number.	Yes	MSA Data Capture Unit/myMSA, Processing plant production management system	For more information on MSA visit the MLA website.

Production Date (YYMMDD)	Encoded in the GS1 barcode, this is the 'kill' or slaughter' date of the product and is recorded in the format year, month, day (YYMMDD).	Yes	Carcase Ticket, Processing plant production management system	For more information visit the GS1 website.
Serial Number	Encoded in the GS1 barcode, this is a code, numeric or alphanumeric, assigned to an individual instance of an item for its lifetime.	Yes	Carcase Ticket, Processing plant production management system	For more information visit the GS1 website.
Slaughter or processing date	This is the date on which livestock were slaughtered by the processor or the day on which carcasses were processed (if different to slaughter date).	Yes	MSA Data Capture Unit/myMSA, Processing plant production management system	
Trade description	This is a collective set of words that says what the product is and may include information such as species, net weight of product, name and address of establishments, category ciphers, market endorsements, MSA eating quality etc.	Yes	Carcase Ticket, Processing plant production management system	

5.2.2.3.5 Regulatory and Industry Programs

- AUS-MEAT
- Australian Meat Industry Council (AMIC)
- Department of Agriculture
- eNVD
- Livestock Production Assurance (LPA)
- Meat Standards Australia (MSA)
- National Livestock Identification System (NLIS)
- State food authority
- Other data sources

5.2.2.3.6 Supply Chain Node Traceability

Traceability of whole carcasses back to the live animal or consignment group is possible, depending on the NLIS tag type, and can be done by the processing establishment where the animal was slaughtered. Here, carcasses are issued a carcass ticket which correlates to the PIC number or live animal identifier and contains key information, including GS1 meat industry barcode, body number, processing establishment number and production date or 'kill date'. This information is uploaded to the NLIS Database, by the processor, under the processing establishments Property Identification Code (PIC). Thus, whole carcasses (identified with a unique serialised carcass ticket) within a processing facility, chiller, cold store, or that are loaded for export or transport to other premises (e.g., retail) are fully traceable back to the individual live animal, or the consignment group and property of origin.

5.2.2.3.7 Data flow diagrams

Table 29: Data flow diagrams for the inputs and outputs of a s small stock slaughter system

Direction	Description
Input	Slaughter to Carcase Chiller
Output	Carcase Chiller to Boning Room
Output	Carcase Chiller to Cold Store (Carcase)
Output	Carcase Chiller to Render

5.2.2.3.7.1 Slaughter to Carcase Chiller

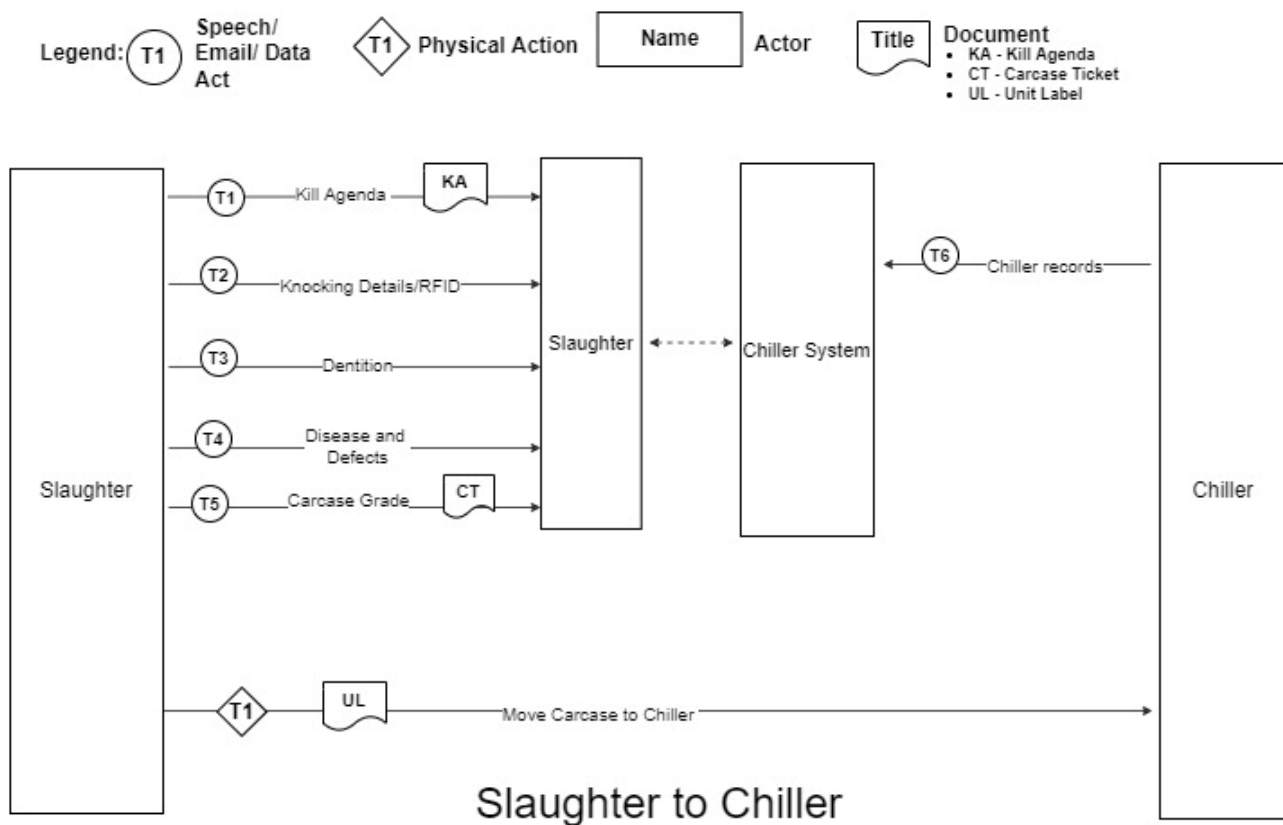

Figure 31: Data or information flows from slaughter to chillers in the small stock supply chain

5.2.2.3.7.2 Carcase chiller to boning room

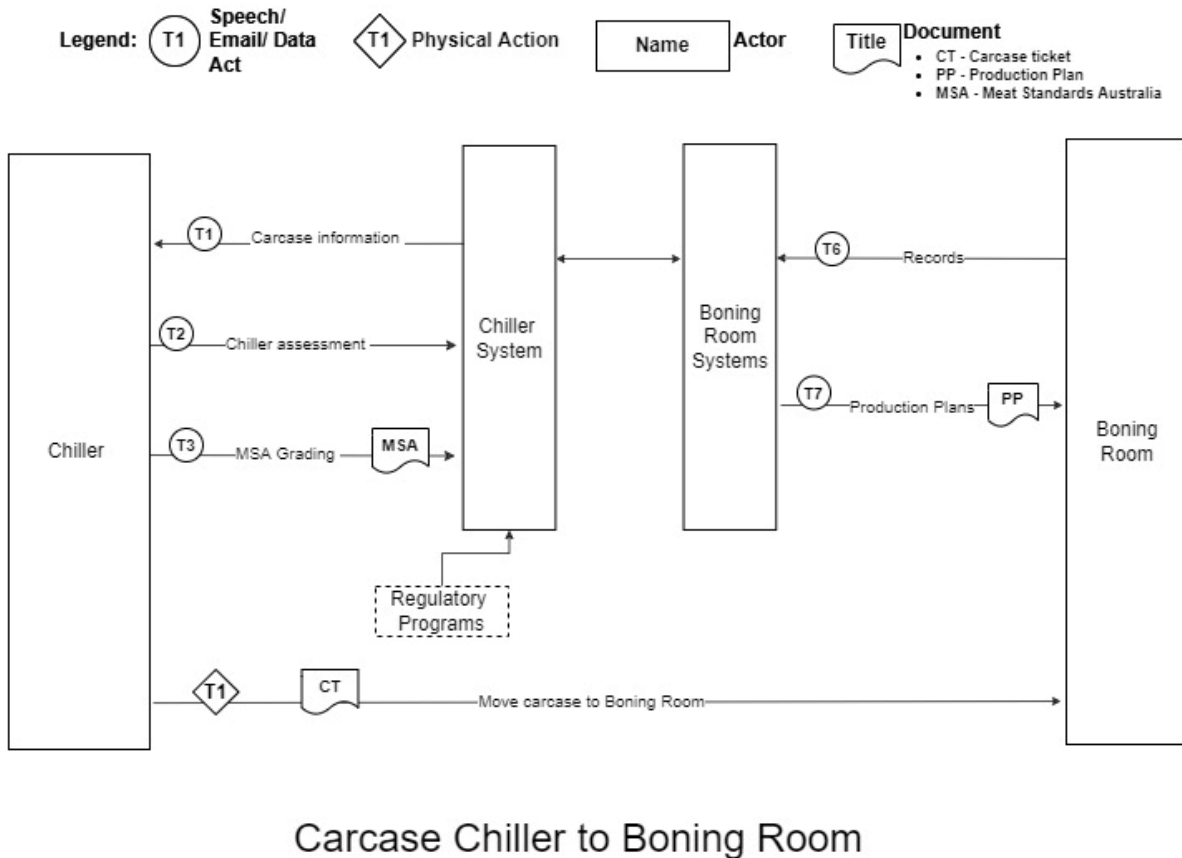

Figure 32: Data or information flows from the carcase chiller to boning room in the small stock supply chain

5.2.2.3.7.3 Carcase Chiller to Cold Store

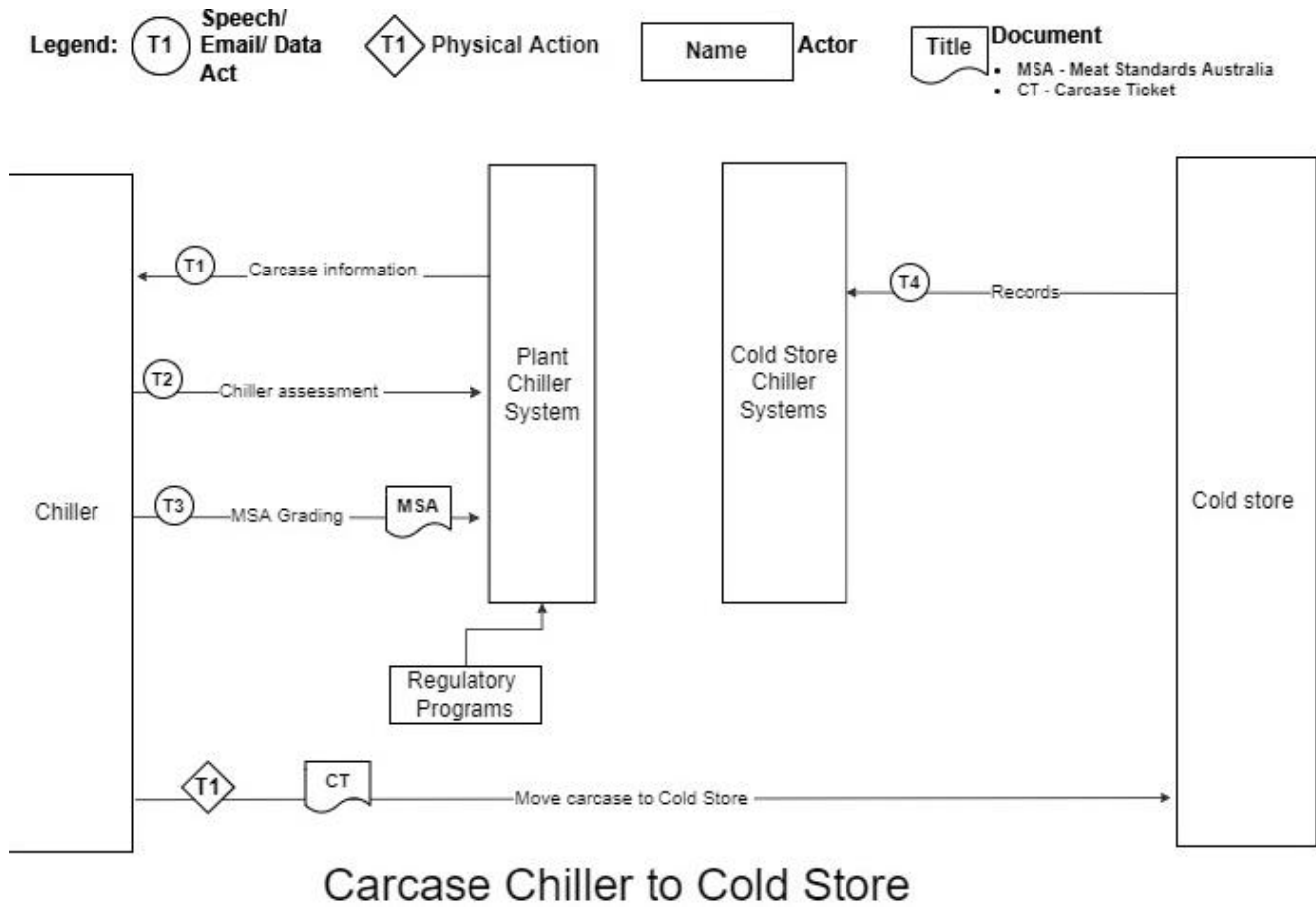

Figure 33: Data or information flows from the carcase chiller to cold stores in the small stock supply chain

5.2.2.3.7.4 Carcase chiller to Rendering

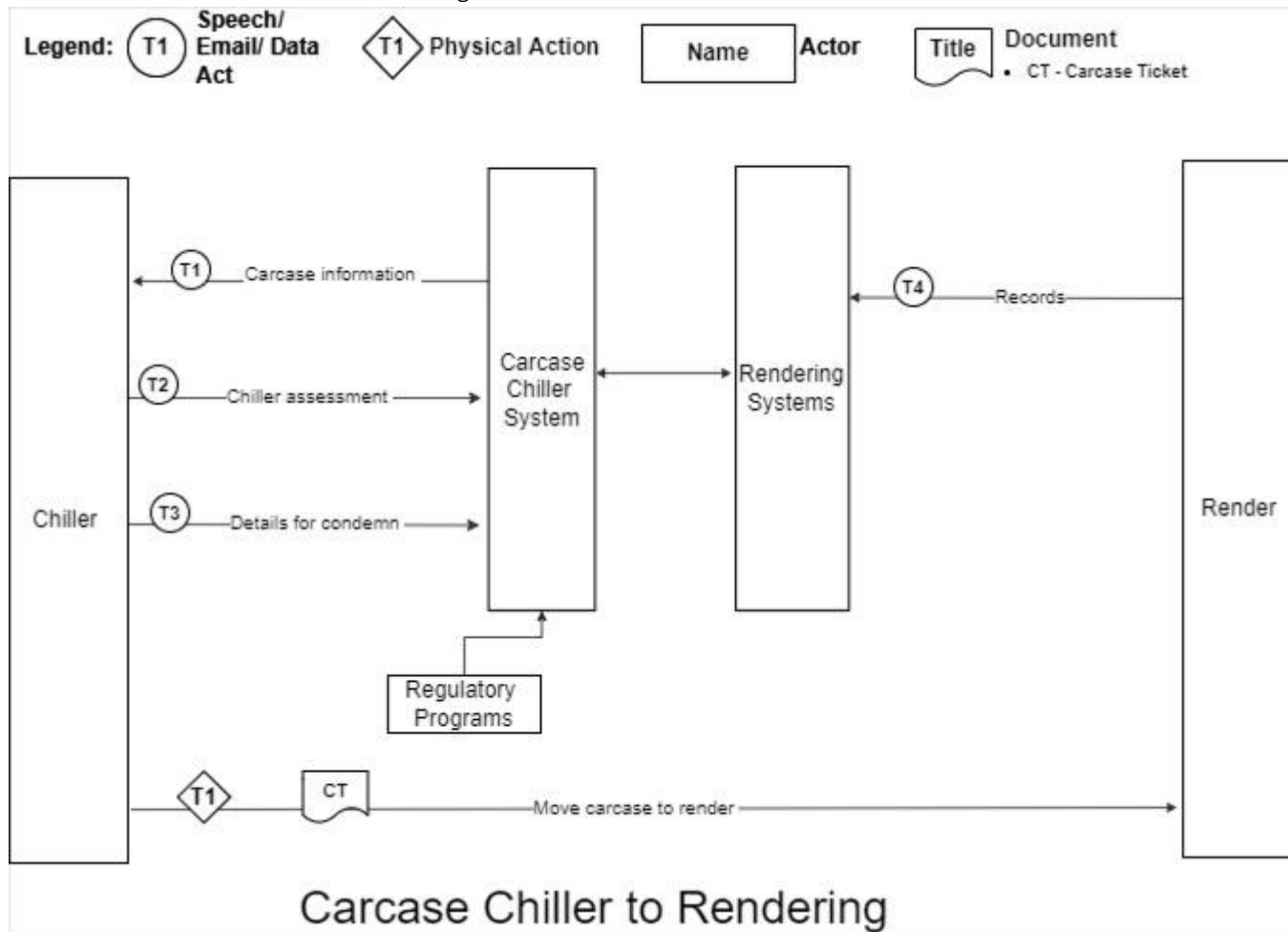

Figure 34: Data or information flows from the carcase chiller to rendering in the small stock supply chain

5.2.2.4 Boning room

Boning is a process or procedure whereby meat is removed from carcasses or carcase parts, or bone-in or boneless meat cuts are produced. The boning room is the location where these activities occur. Typically, carcasses enter the boning room after chilling and are broken down into portions and cuts such as primal, sub-primal and trim cuts. This process is very critical, as any errors in cutting can decrease the value of a cut and impact directly on profit. Additionally, there is a high risk of cross-contamination to the cuts and health and safety risks to workers operating the boning room tools and machinery.

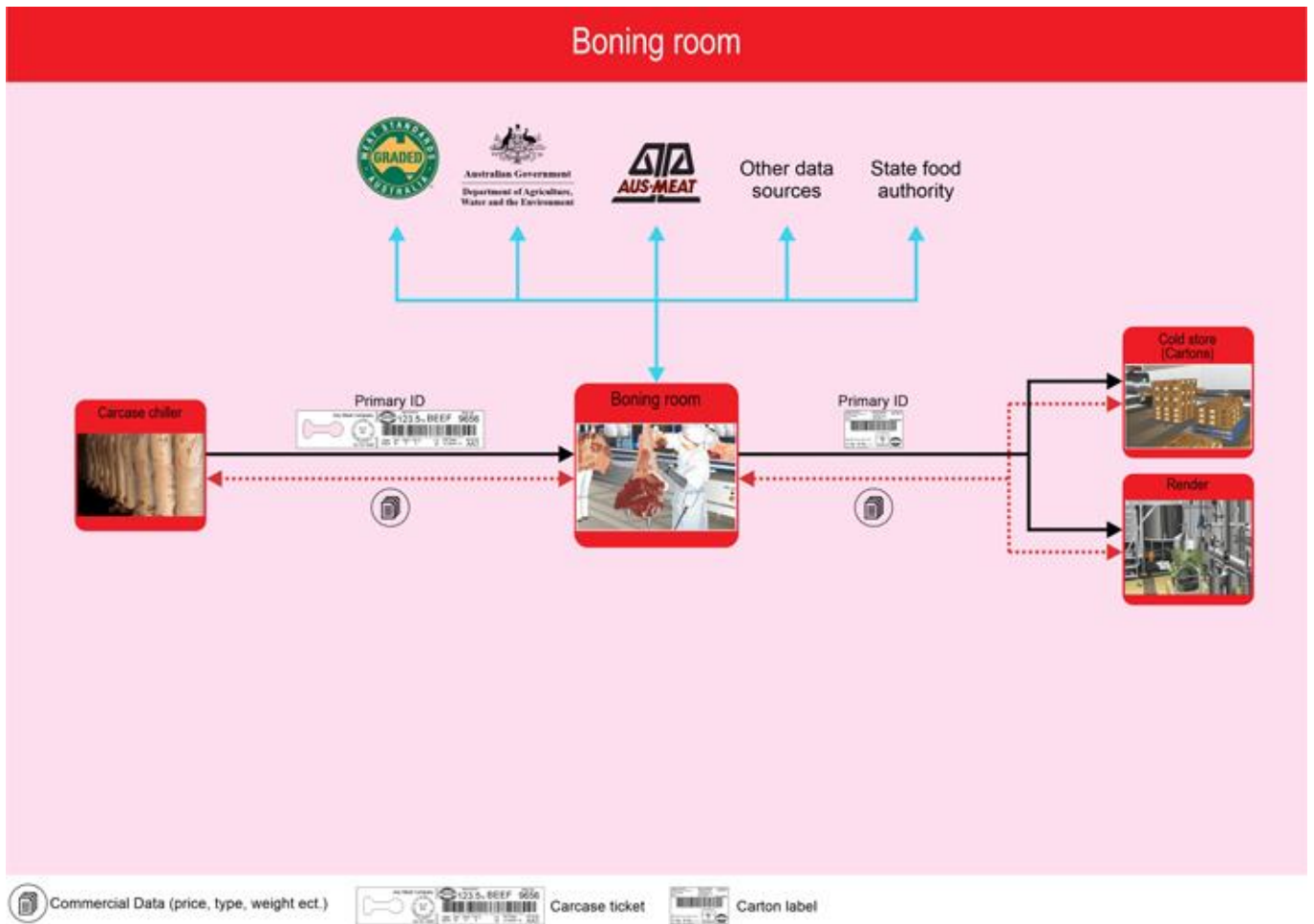

Figure 35. Inputs and outputs of the small stock supply chain boning room sector.

5.2.2.4.1 Physical Inputs including Critical Tracking Events (CTEs)

Physical inputs into the boning room related to product traceability are those carcasses transferred out of the carcass chiller system. This includes the CTE documentation such as the carcass ticket.

Critical Tracking Events (CTEs) are defined as those events which include the growing, receiving, transforming, creating, and shipping of food products. Such events are critical to the traceability of product throughout the supply chain.

The CTEs associated with inputs to the boning room system include the receipt of:

- Carcass.

Table 30. Physical inputs and associated Critical Tracking Event related documents for a small stock boning room system.

Event related to the inputs	Description of the inputs	Critical Tracking Event (CTE) related documents (including electronic)	More details
Carcass	The body of a slaughtered animal after bleeding. Becomes a dressed carcass when hide/skin, head, feet, and offal are removed.	Carcass Ticket, MSA Carcass Ticket, Processing plant production management system	

5.2.2.4.2 Information Inputs including Key Data Elements (KDEs)

Key Data Elements (KDEs) are defined as those elements which are key in identifying and tracing the Critical Tracking Event (CTE). The information inputs associated with the movement of carcasses into the boning room can largely be found on the carcass ticket. This may include the GS1 barcode as well as other carcass information. In addition, carcasses will be classified into different MSA eating quality grade groups for boning of like carcasses.

Table 31. Information inputs, Key Data Elements and Critical Tracking Event related documentation for a small stock boning room system.

Attributes (including KDEs)	Description of the Attributes (including KDEs)	Is a KDE	Critical Tracking Event (CTE) related documents (including electronic)	More details
Body number	This is a number assigned to each carcass by the processor for identification purposes.	Yes	Carcass Ticket, Processing plant production management system	
From Establishment number	A number issued by Federal and State Authorities to identify the originating site from which meat or meat products were distributed to domestic or export markets. For transfer certificates, the Establishment numbers for both the dispatching and receiving establishments are recorded.	Yes	Carcass Ticket, Processing plant production management system	
Global Trade Item Number (GTIN)	Encoded in the GS1 barcode, the GTIN is a globally unique 14-digit number used to identify trade items, products, or services.	Yes	Carcass Ticket, Processing plant production management system	For more information visit the GS1 website.
Lot number	A lot is a number assigned by the processor to each group of livestock consigned to slaughter and is usually vendor specific.	Yes	Carcass Ticket, Processing plant production management system	
MSA eating quality group/grade	This identifies carcasses with similar MSA and eating quality grades, these may align with brands packed by the processor for logistic simplicity. Carcasses are grouped for boning according to eating quality grades.	Yes	MSA Carcass Ticket, Processing plant production management system	For more information on MSA visit the MLA website.
Net Weight (Kilograms)	Usually encoded in the GS1 barcode, the Net Weight is a variable measure of the trade item e.g., carton, pallet or shipment recorded in kilograms.	Yes	Carcass Ticket, Processing plant production management system	For more information visit the GS1 website.

Official mark	Any stamp, seal, label, or mark that is declared by the regulations to be an official mark. An official mark signifies that the product has been inspected by and approved as safe for human consumption by an Authorised Officer.	Yes	Carcase Ticket	
Production Date (YYMMDD)	Encoded in the GS1 barcode, this is the 'kill' or slaughter' date of the product and is recorded in the format year, month, day (YYMMDD).	Yes	Carcase Ticket, Processing plant production management system	For more information visit the GS1 website.
Serial Number	Encoded in the GS1 barcode, this is a code, numeric or alphanumeric, assigned to an individual instance of an item for its lifetime.	Yes	Carcase Ticket, Processing plant production management system	For more information visit the GS1 website.
Trade description	This is a collective set of words that says what the product is and may include information such as species, net weight of product, name and address of establishments, category ciphers, market endorsements, MSA eating quality etc.	Yes	Carcase Ticket, Processing plant production management system	

5.2.2.4.3 Physical Outputs including Critical Tracking Events (CTEs)

The output of the Boning room is meat which can be classified, measured, and identified as red meat products for human consumption or condemned carcass parts such as trim. Product for human consumption may be packaged into cartons or onto pallets for transport.

Critical Tracking Events (CTEs) are defined as those events which include the growing, receiving, transforming, creating, and shipping of food products. Such events are critical to the traceability of product throughout the supply chain.

The CTEs associated with the outputs of the boning room system include the movement of:

- Carton
- Condemned carcass parts
- Pallet

off the property, premises, or supply chain sector.

Table 32. Physical outputs and associated Critical Tracking Event related documents for a small stock boning room system.

Event related to the inputs	Description of the inputs	Critical Tracking Event (CTE) related documents (including electronic)	More details
Carton	This is a case, crate, or barrel of product.	Carton label, Official seal, Processing plant production management system	

Condemned carcass parts	The body of a slaughtered animal deemed unfit for human consumption. This may be a condemned dressed carcass when hide/skin, head, feet, and offal are removed.	Processing plant production management system	
Pallet	A logistic unit which includes a number of cartons or goods items packed together for transport or storage purposes.	Processing plant production management system, SSCC/Pallet label	

5.2.2.4.4 Information Outputs including Key Data Elements (KDEs)

Key Data Elements (KDEs) are defined as those elements which are key in identifying and tracing the Critical Tracking Event (CTE). The information outputs associated with the movement of product out of the boning room is found on the carton and pallet labels. This information is also recorded in the processing plants production management system and includes application identifiers from the GS1 barcodes as well as other trade description information.

Table 33. Information outputs, Key Data Elements and Critical Tracking Event related documentation for a small stock boning room system.

Attributes (including KDEs)	Description of the Attributes (including KDEs)	Is a KDE	Critical Tracking Event (CTE) related documents (including electronic)	More details
Company/product code	This is an in-house code for the identification of the product in the unit.	Yes	Carton label, Processing plant production management system, SSCC/Pallet label	
Consignment Serial Shipping Container Code (SSCC)	Encoded in the GS1 barcode, this is a unique number which identifies the individual logistic unit i.e., shipment/message that is assigned by the establishment constructing the unit. The SSCC remains the same for the life of the logistic unit.	Yes	Processing plant production management system, SSCC/Pallet label	For more information visit the GS1 website.
Count of Trade Items	Usually encoded in the GS1 barcode, this is the number of trade items e.g., cartons in the logistic unit.	Yes	Processing plant production management system, SSCC/Pallet label	For more information visit the GS1 website.
From Establishment number	A number issued by Federal and State Authorities to identify the originating site from which meat or meat products were distributed to domestic or export markets. For transfer certificates, the Establishment numbers for both the dispatching and receiving establishments are recorded.	Yes	Carton label, Processing plant production management system,	

			SSCC/Pallet label	
Global Trade Item Number (GTIN)	Encoded in the GS1 barcode, the GTIN is a globally unique 14-digit number used to identify trade items, products, or services.	Yes	Carton label, Processing plant production management system, SSCC/Pallet label	For more information visit the GS1 website.
GTIN of Contained Trade Items	Encoded in the GS1 barcode, the GTIN of the contained trade items is a globally unique 14-digit number used to identify trade items, products, or services in the logistic unit.	Yes	Processing plant production management system, SSCC/Pallet label	For more information visit the GS1 website.
Net Weight (Kilograms)	Usually encoded in the GS1 barcode, the Net Weight is a variable measure of the trade item e.g., carton, pallet or shipment recorded in kilograms.	Yes	Carton label, Processing plant production management system, SSCC/Pallet label	For more information visit the GS1 website.
Official mark	Any stamp, seal, label, or mark that is declared by the regulations to be an official mark. An official mark signifies that the product has been inspected by and approved as safe for human consumption by an Authorised Officer.	Yes	Carton label, SSCC/Pallet label	
Packaging Date	Encoded in the GS1 barcode, the Packaging Date is the date on which the item was packaged and is recorded in the format year, month, day (YYMMDD).	Yes	Carton label, Processing plant production management system, SSCC/Pallet label	For more information visit the GS1 website.
Packaging Date Range	This includes the oldest and newest packaging dates for the logistic unit.	Yes	Processing plant production management system, SSCC/Pallet label	For more information visit the GS1 website.
Pallet Serial Shipping Container Code (SSCC)	Encoded in the GS1 barcode, this is a unique number which identifies the individual logistic unit i.e., pallet that is assigned by the establishment constructing the unit. The SSCC remains the same for the life of the logistic unit.	Yes	Processing plant production management system, SSCC/Pallet label	For more information visit the GS1 website.

Seal Serial Number	This is a unique serial number printed on any tamper-evident seal issued by the Department.	Yes	Official seal, Processing plant production management system	For more information visit the Australian Government Federal Register of Legislation.
Serial Number	Encoded in the GS1 barcode, this is a code, numeric or alphanumeric, assigned to an individual instance of an item for its lifetime.	Yes	Carton label, Processing plant production management system	For more information visit the GS1 website.
Shipping Mark	Also known as a port mark, this is a code comprising of three letters representing the foreign establishment number and the last nine digits of the consignment SSCC.	Yes	Processing plant production management system, SSCC/Pallet label	
Trade description	This is a collective set of words that says what the product is and may include information such as species, net weight of product, name and address of establishments, category ciphers, market endorsements, MSA eating quality etc.	Yes	Carton label, Processing plant production management system, SSCC/Pallet label	

5.2.2.4.5 Regulatory and Industry Programs

- Meat Standards Australia (MSA)
- AUS-MEAT
- Australian Meat Industry Council (AMIC)
- Department of Agriculture
- State food authority
- Other data sources

5.2.2.4.6 Supply Chain Node Traceability

Traceability for cartoned and palletised product is limited to the carcasses that have entered the boning room for the production run of cartons that are created. For example, 200 carcasses individually identified with unique carcass tickets enter the boning room for a specific boning run. These carcass tickets are linked to the specific boning run. From these 200 cartons of primal cuts and 200 cartons of trim and other highly mixed products are created. While all cartons are identified with unique serialised carton labels, including a GS1 meat industry barcode, linked to the boning run (and may be packaged into pallets containing unique serialised pallet labels including a GS1 SSCC barcode), it is not readily possible to identify which carcasses are in which cartons as the cartons will contain meat products from different carcasses. If the carcasses were sourced from several different properties, the resulting carton can only be traced to a number of possible carcasses and source properties.

5.2.2.4.7 Data flow diagrams

Table 34. Data flow diagrams for the inputs and outputs of a small stock boning room system.

Direction	Description
Input	Chiller to Boning room
Output	Boning room to Carton chiller
Output	Boning room to Carton freezer
Output	Boning room to Render

5.2.2.4.7.1 Chiller to Boning room

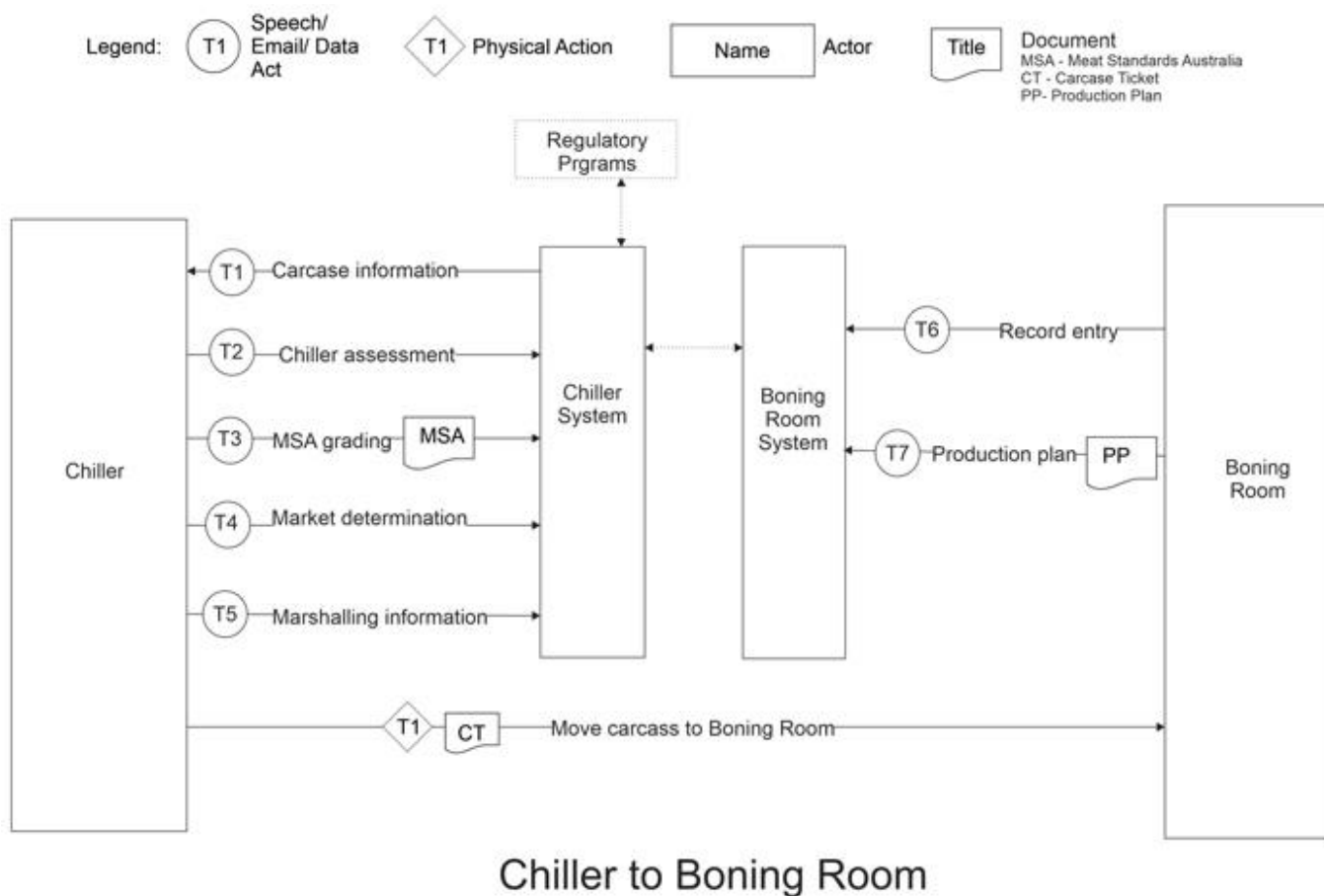
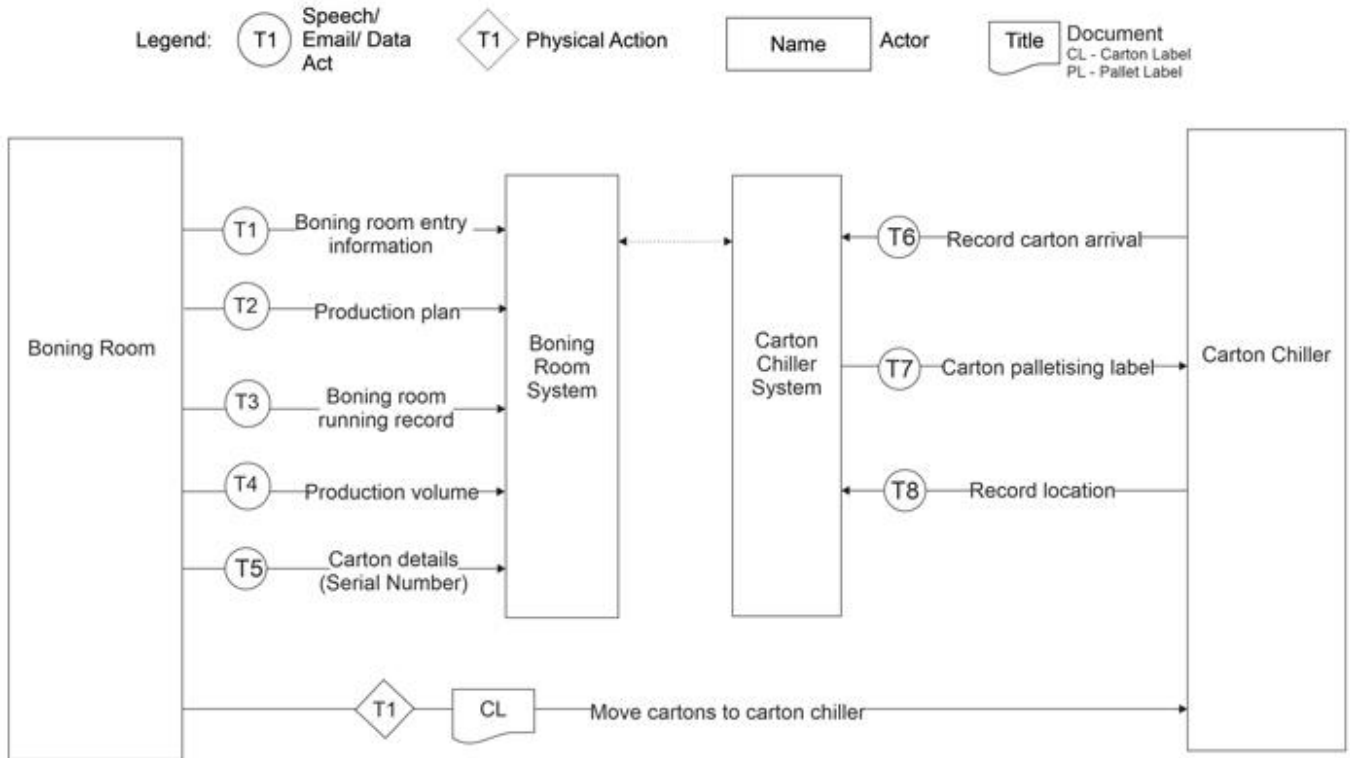

Figure 36. Data or information flows from the carcass chiller to boning room systems in the small stock supply chain.

5.2.2.4.7.2 Boning room to Carton chiller



Boning Room to Carton Chiller

Figure 37. Data or information flows from the boning room to carcass chiller systems in the small stock supply chain.

5.2.2.4.7.3 Boning room to Carton freezer

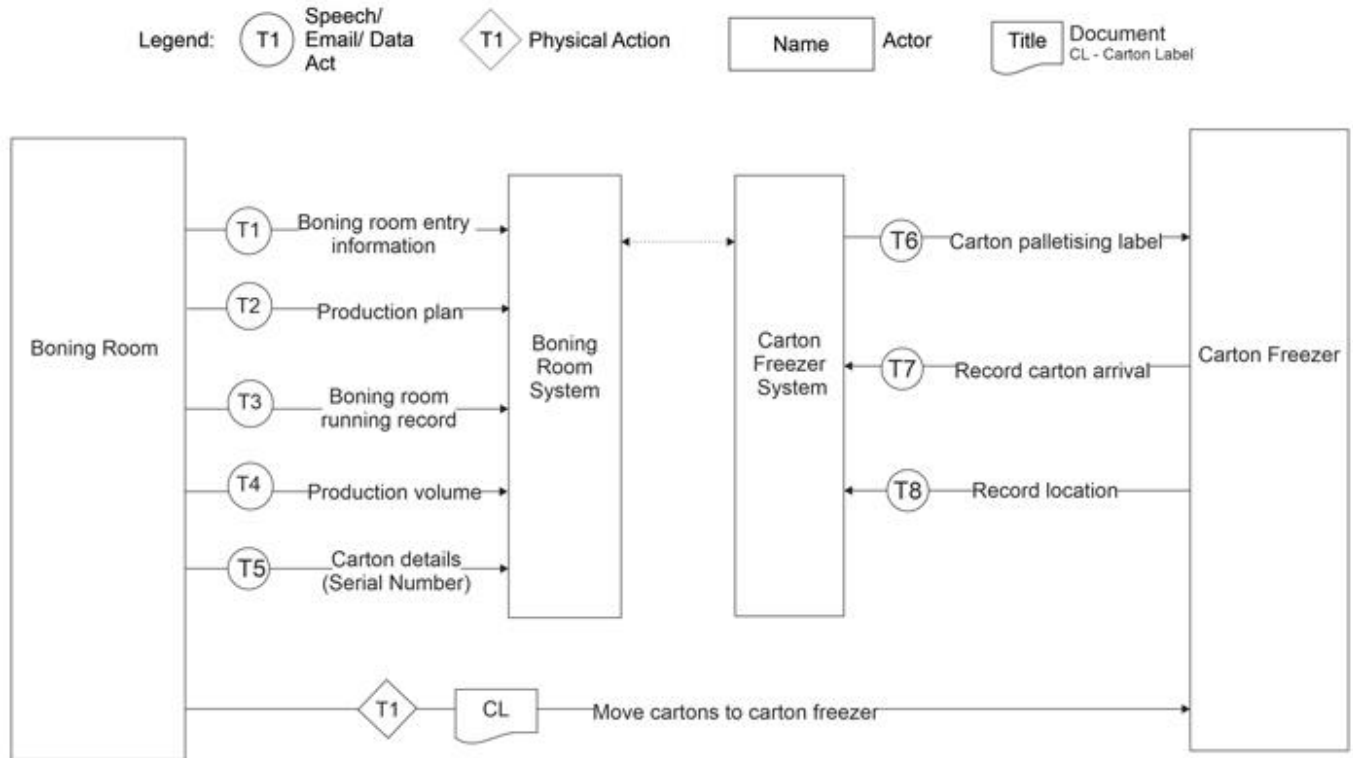

Boning Room to Carton Freezer

Figure 38. Data or information flows from the boning room to carton freezer systems in the small stock supply chain.

5.2.2.4.7.4 Boning room to Render

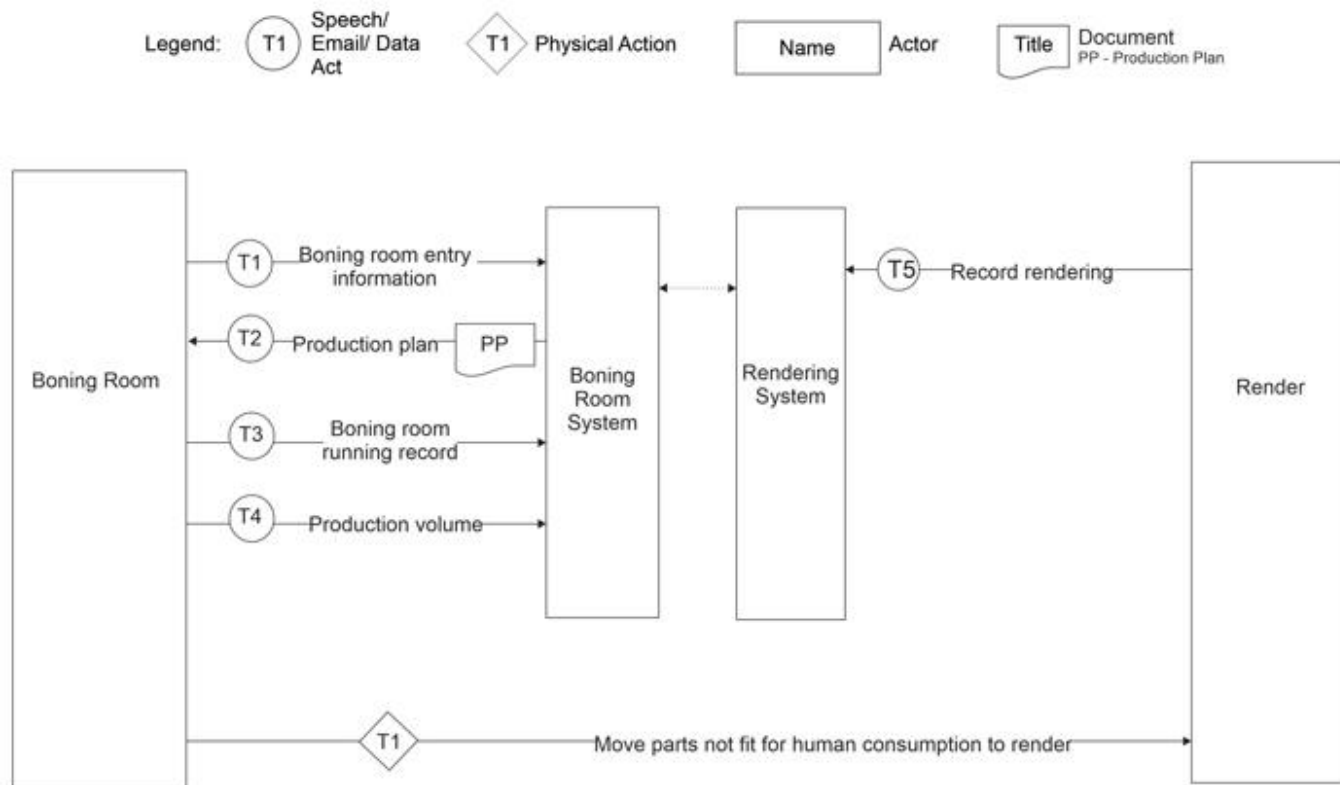

Boning Room to Render

Figure 39. Data or information flows from the boning room to render systems in the small stock supply chain.

5.2.2.5 Offal room

At slaughter carcasses are eviscerated; the internal organs (green and red offal) are removed. Green offal includes the stomach, intestines, and additional parts of the digestive tract while red offal includes the heart, kidneys, lungs, and liver. These products are first inspected by Authorised Government Officers for compliance with food safety standards and then enter the offal room where they are processed and packaged for sale. With offal likely to develop off conditions far more quickly than carcass product, it essential that offal is processed carefully, hygienically, and refrigerated as quickly as possible.

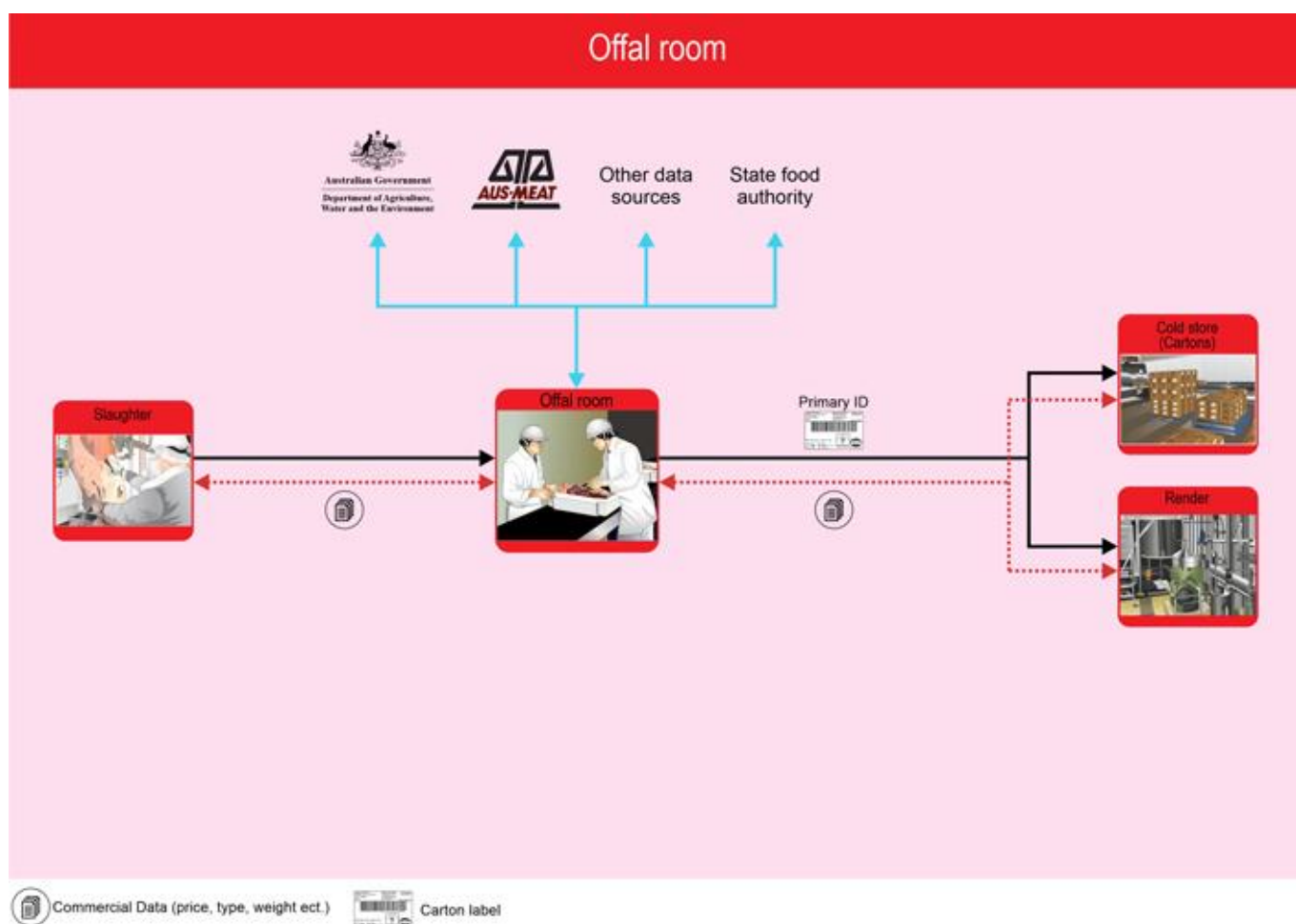

Figure 40. Inputs and outputs of the small stock supply chain offal room sector.

5.2.2.5.1 Physical Inputs including Critical Tracking Events (CTEs)

The physical inputs into the offal room include the offal products e.g., heart, liver, lungs.

Critical Tracking Events (CTEs) are defined as those events which include the growing, receiving, transforming, creating, and shipping of food products. Such events are critical to the traceability of product throughout the supply chain.

The CTEs associated with inputs to the offal room system include the receipt of:

- Offal.

Table 35. Physical inputs and associated Critical Tracking Event related documents for a small stock offal room system.

Event related to the inputs	Description of the inputs	Critical Tracking Event (CTE) related documents (including electronic)	More details
Offal	The organs of the thoracic and abdominal cavities, the brain, the muscular tissues of the head and diaphragm, the tail, feet, or tendons.	Processing plant production management system	

5.2.2.5.2 Information Inputs including Key Data Elements (KDEs)

Key Data Elements (KDEs) are defined as those elements which are key in identifying and tracing the Critical Tracking Event (CTE). Information inputs into the offal room are those which are found in the processors production management system and include basic product information such as establishment number and slaughter or processing date.

Table 36. Information inputs, Key Data Elements and Critical Tracking Event related documentation for a small stock offal room system.

Attributes (including KDEs)	Description of the Attributes (including KDEs)	Is a KDE	Critical Tracking Event (CTE) related documents (including electronic)	More details
Batch number	This is a unique number which identifies products sharing certain production characteristics and is used for traceability purposes.	Yes	Processing plant production management system	
From Establishment number	A number issued by Federal and State Authorities to identify the originating site from which meat or meat products were distributed to domestic or export markets. For transfer certificates, the Establishment numbers for both the dispatching and receiving establishments are recorded.	Yes	Processing plant production management system	
Lot number	A lot is a number assigned by the processor to each group of livestock consigned to slaughter and is usually vendor specific.	Yes	Processing plant production management system	
Slaughter or processing date	This is the date on which livestock were slaughtered by the processor or the day on which carcasses were processed (if different to slaughter date).	Yes	Processing plant production management system	

5.2.2.5.3 Physical Outputs including Critical Tracking Events (CTEs)

Physical outputs of the offal room include offal products which have been packaged into cartons or pallets for transport. Critical Tracking Event documentation accompanying these outputs include carton and pallet labels. In addition, condemned offal, product that is unsuitable for market may be sent to render. This information is all recorded in the processors production management system.

Critical Tracking Events (CTEs) are defined as those events which include the growing, receiving, transforming, creating, and shipping of food products. Such events are critical to the traceability of product throughout the supply chain.

The CTEs associated with the outputs of the offal room system include the movement of:

- Carton
- Condemned offal
- Pallet

off the property, premises, or supply chain sector.

Table 37. Physical outputs and associated Critical Tracking Event related documents for a small stock offal room system.

Event related to the inputs	Description of the inputs	Critical Tracking Event (CTE) related documents (including electronic)	More details
Carton	This is a case, crate, or barrel of product.	Carton label, Official seal, Processing plant production management system	
Condemned offal	Offal tissues deemed unfit for human consumption.	Processing plant production management system	
Pallet	A logistic unit which includes a number of cartons or goods items packed together for transport or storage purposes.	Processing plant production management system, SSCC/Pallet label	

5.2.2.5.4 Information Outputs including Key Data Elements (KDEs)

Key Data Elements (KDEs) are defined as those elements which are key in identifying and tracing the Critical Tracking Event (CTE). Information outputs from the offal room can be found on the carton and pallet labels and is stored in the processors production management system for traceability. Such information includes application identifiers included in the GS1 barcode as well as trade description information.

Table 38. Information outputs, Key Data Elements and Critical Tracking Event related documentation for a small stock offal room system.

Attributes (including KDEs)	Description of the Attributes (including KDEs)	Is a KDE	Critical Tracking Event (CTE) related documents (including electronic)	More details
Company/product code	This is an in-house code for the identification of the product in the unit.	Yes	Carton label, Processing plant production management system, SSCC/Pallet label	
Consignment Serial Shipping Container Code (SSCC)	Encoded in the GS1 barcode, this is a unique number which identifies the individual logistic unit i.e., shipment/message that is assigned by the establishment constructing the unit. The SSCC remains the same for the life of the logistic unit.	Yes	Processing plant production management system, SSCC/Pallet label	For more information visit the GS1 website.
Count of Trade Items	Usually encoded in the GS1 barcode, this is the number of trade items e.g., cartons in the logistic unit.	Yes	Processing plant production management system, SSCC/Pallet label	For more information visit the GS1 website.
From Establishment number	A number issued by Federal and State Authorities to identify the originating site from which meat or meat products were distributed	Yes	Carton label, Processing plant	

	to domestic or export markets. For transfer certificates, the Establishment numbers for both the dispatching and receiving establishments are recorded.		production management system, SSCC/Pallet label	
Global Trade Item Number (GTIN)	Encoded in the GS1 barcode, the GTIN is a globally unique 14-digit number used to identify trade items, products, or services.	Yes	Carton label, Processing plant production management system, SSCC/Pallet label	For more information visit the GS1 website.
GTIN of Contained Trade Items	Encoded in the GS1 barcode, the GTIN of the contained trade items is a globally unique 14-digit number used to identify trade items, products, or services in the logistic unit.	Yes	Processing plant production management system, SSCC/Pallet label	For more information visit the GS1 website.
Net Weight (Kilograms)	Usually encoded in the GS1 barcode, the Net Weight is a variable measure of the trade item e.g., carton, pallet or shipment recorded in kilograms.	Yes	Carton label, Processing plant production management system, SSCC/Pallet label	For more information visit the GS1 website.
Official mark	Any stamp, seal, label, or mark that is declared by the regulations to be an official mark. An official mark signifies that the product has been inspected by and approved as safe for human consumption by an Authorised Officer.	Yes	Carton label, SSCC/Pallet label	
Packaging Date	Encoded in the GS1 barcode, the Packaging Date is the date on which the item was packaged and is recorded in the format year, month, day (YYMMDD).	Yes	Carton label, Processing plant production management system, SSCC/Pallet label	For more information visit the GS1 website.
Packaging Date Range	This includes the oldest and newest packaging dates for the logistic unit.	Yes	Processing plant production management system, SSCC/Pallet label	For more information visit the GS1 website.
Pallet Serial Shipping Container Code (SSCC)	Encoded in the GS1 barcode, this is a unique number which identifies the individual logistic unit i.e., pallet that is assigned by the establishment constructing the unit. The SSCC remains the same for the life of the logistic unit.	Yes	Processing plant production management system,	For more information visit the GS1 website.

			SSCC/Pallet label	
Seal Serial Number	This is a unique serial number printed on any tamper-evident seal issued by the Department.	Yes	Official seal, Processing plant production management system	For more information visit the GS1 website.
Serial Number	Encoded in the GS1 barcode, this is a code, numeric or alphanumeric, assigned to an individual instance of an item for its lifetime.	Yes	Carton label, Processing plant production management system	For more information visit the GS1 website.
Shipping Mark	Also known as a port mark, this is a code comprising of three letters representing the foreign establishment number and the last nine digits of the consignment SSCC.	Yes	Processing plant production management system, SSCC/Pallet label	For more information visit the Australian Government Federal Register of Legislation.
Trade description	This is a collective set of words that says what the product is and may include information such as species, net weight of product, name and address of establishments, category ciphers, market endorsements, MSA eating quality etc.	Yes	Carton label, Processing plant production management system, SSCC/Pallet label	

5.2.2.5.5 Regulatory and Industry Programs

- Department of Agriculture
- AUS-MEAT
- Australian Meat Industry Council (AMIC)
- State food authority
- Other data sources

5.2.2.5.6 Supply Chain Node Traceability

Traceability for cartoned and palletised offal product is limited to the carcasses which were processed for the particular offal room production run from which cartons were created. For example, 1 000 carcasses are processed and individually identified with unique serialised carcass tickets, including GS1 meat industry barcodes. From these carcasses, 2 000 kidneys enter the offal room for the offal room production run and are packaged into 30 x 10 kg cartons. These cartons are identified by unique serialised carton labels, including a GS1 meat industry barcode, (and may be packaged into pallets containing unique serialised pallet labels including a GS1 SSCC barcode) linked to the offal room production run. It is not readily possible to identify which carcasses are in which cartons as the cartons will contain kidneys from different carcasses. If the carcasses were sourced from several different properties, the resulting carton can only be traced to a number of possible carcasses and source properties.

5.2.2.5.7 Data flow diagrams

Table 39. Data flow diagrams for the inputs and outputs of a small stock offal room system.

Direction	Description
Input	Slaughter floor to Offal room
Output	Offal room to Carton freezer
Output	Offal room to Carton chiller
Output	Offal room to Render

5.2.2.5.7.1 Slaughter floor to Offal room

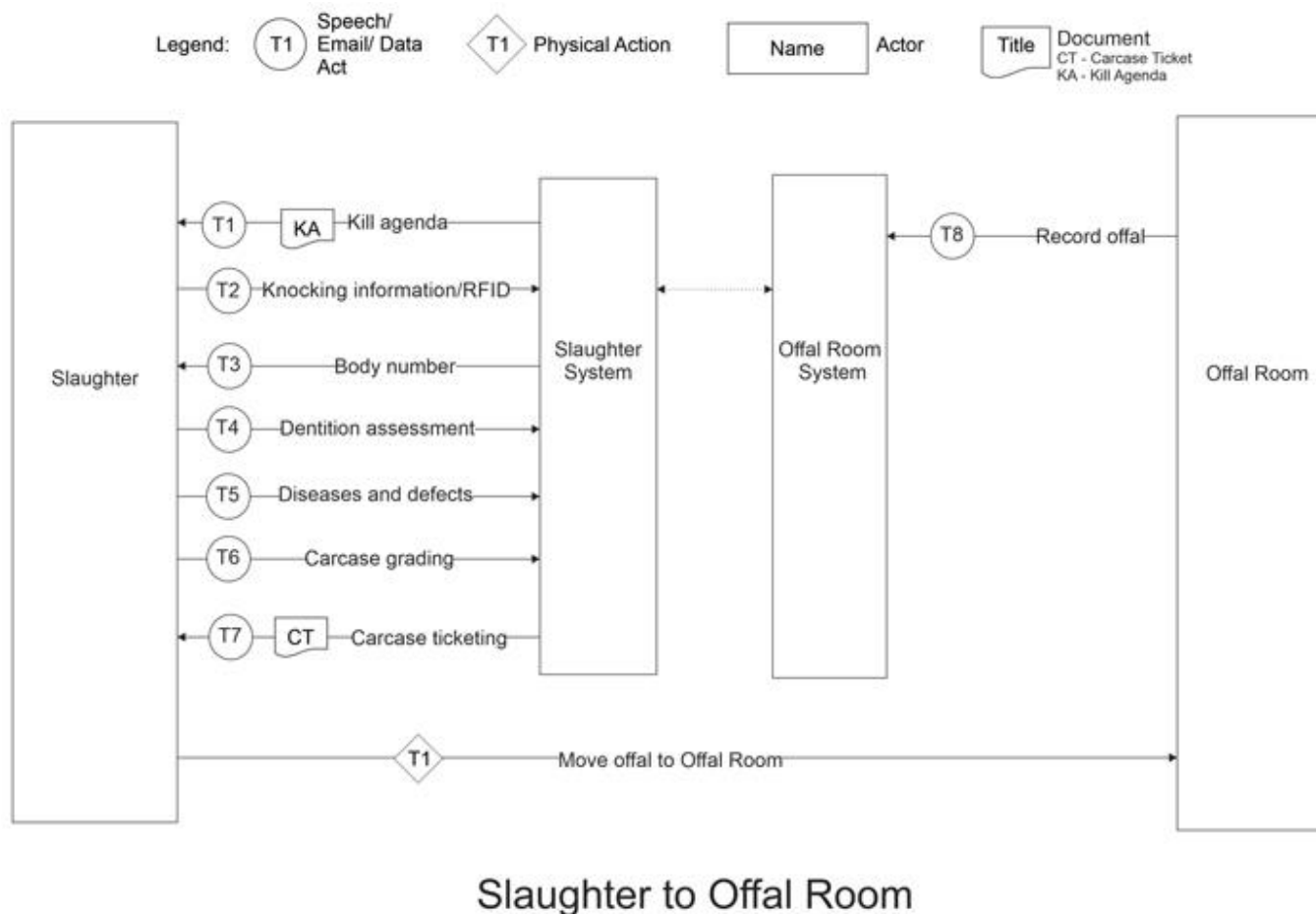
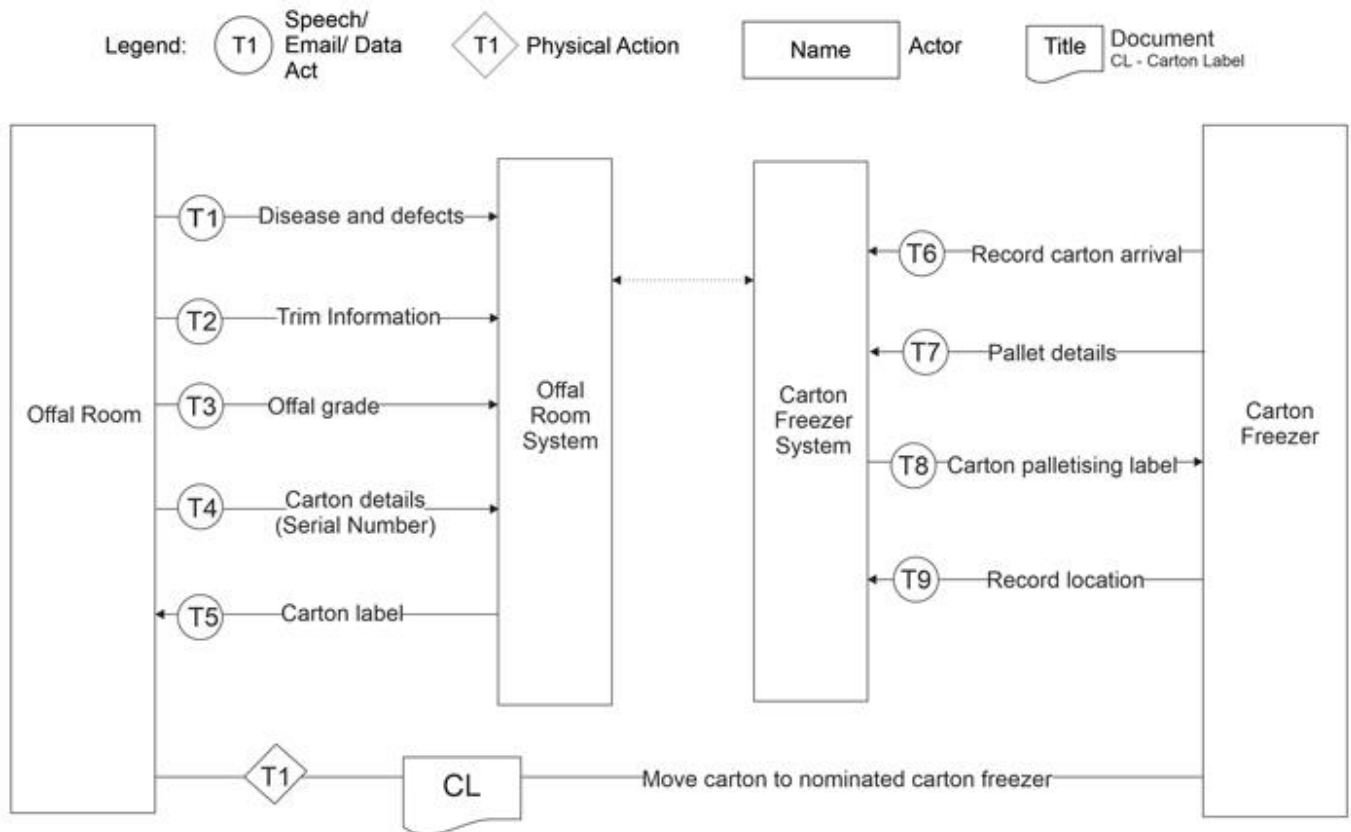

Figure 41. Data or information flows from the slaughter to offal room systems in the small stock supply chain.

5.2.2.5.7.2 Offal room to Carton Freezer



Offal Room to Carton Freezer

Figure 42. Data or information flows from the offal room to carton freezer systems in the small stock supply chain.

5.2.2.5.7.3 Offal room to Carton Chiller

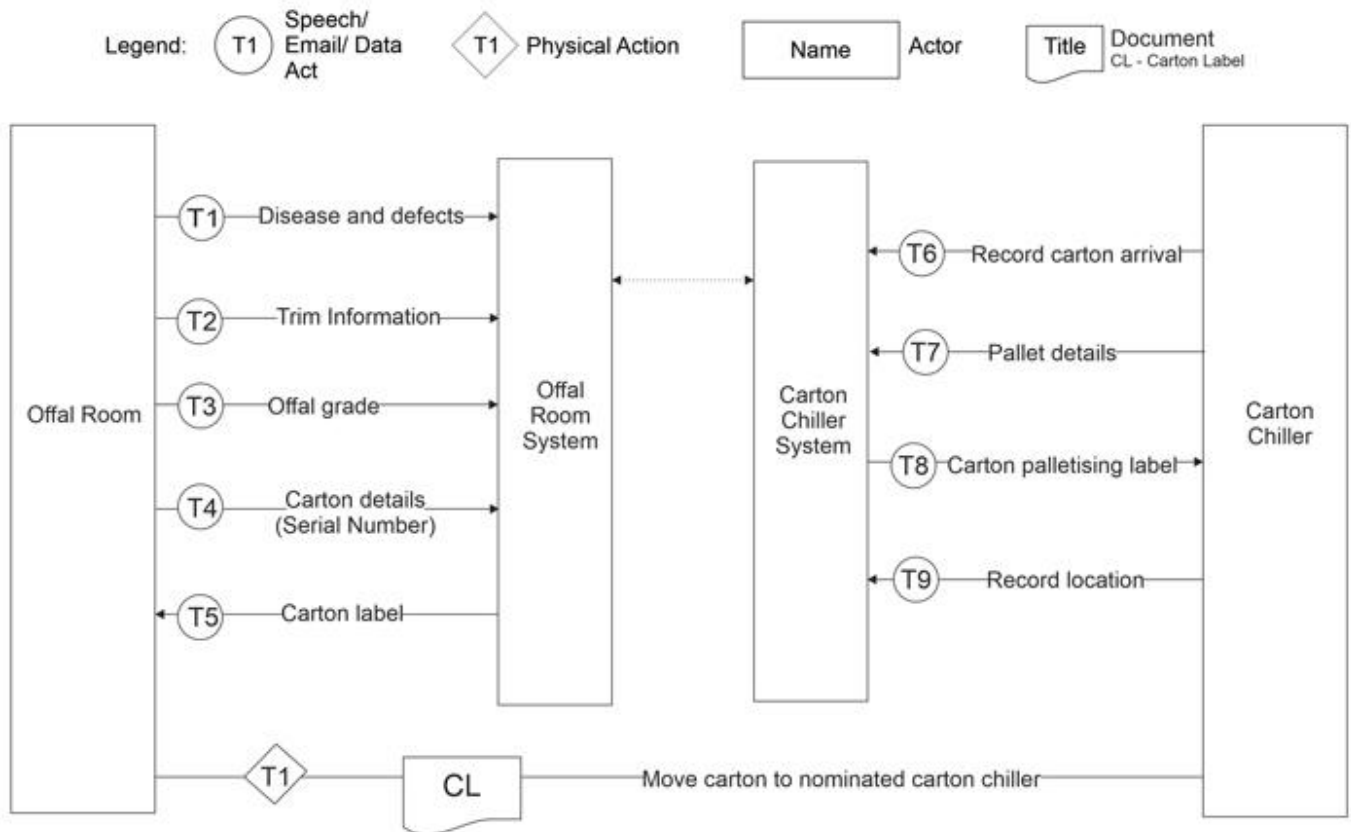

Offal Room to Carton Chiller

Figure 43. Data or information flows from the offal room to carton chiller systems in the small stock supply chain.

5.2.2.5.7.4 Offal room to Carton Render

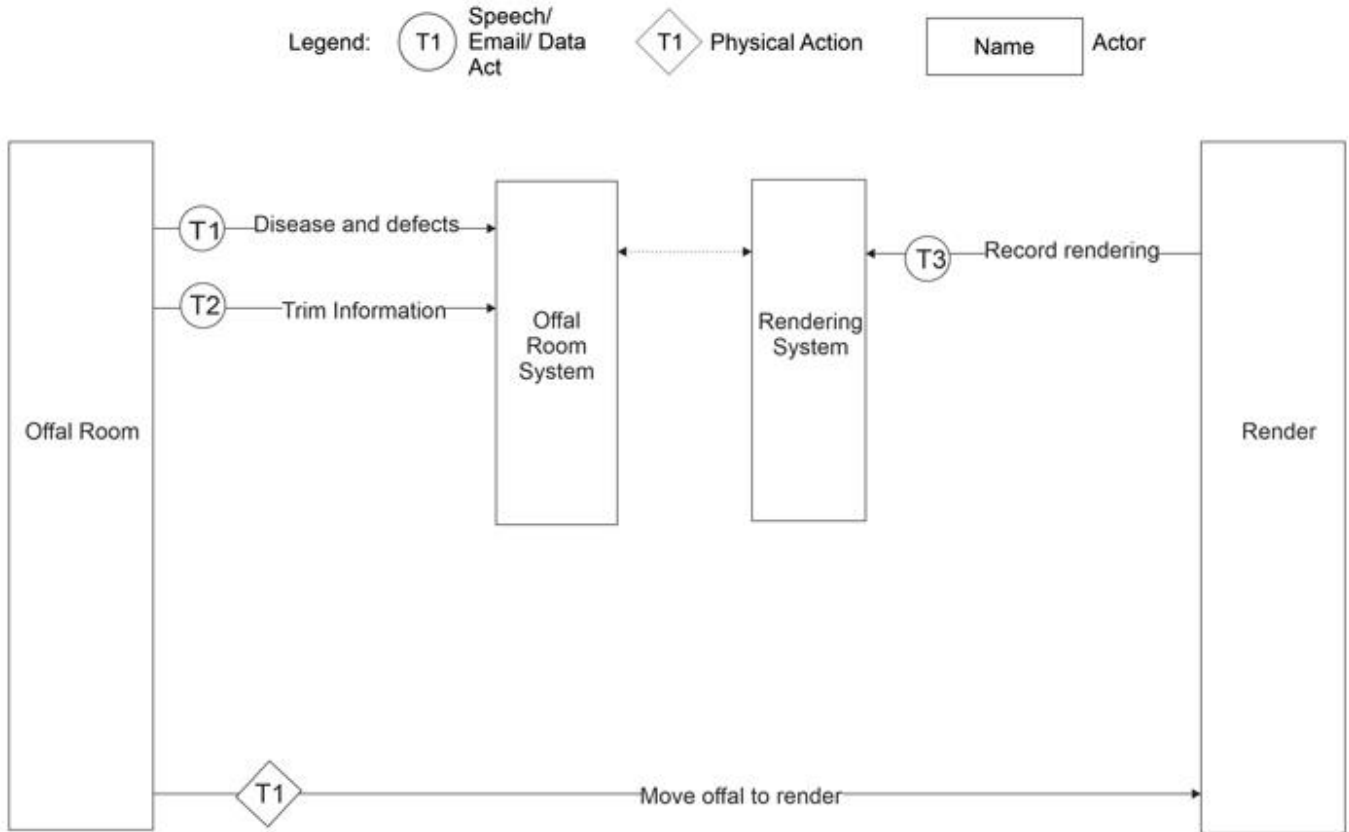

Offal Room to Render

Figure 44. Data or information flows from the offal room to render systems in the small stock supply chain.

5.2.2.6 Render

Rendering is the process of heat-treating raw materials to remove moisture and/or separate fat. Raw materials such as trim and condemned products enter the rendering plant from various processing stages such as slaughter, boning, and the offal room and are converted into non-edible (for humans) by-products such as meat meal, tallow, and bone meal.

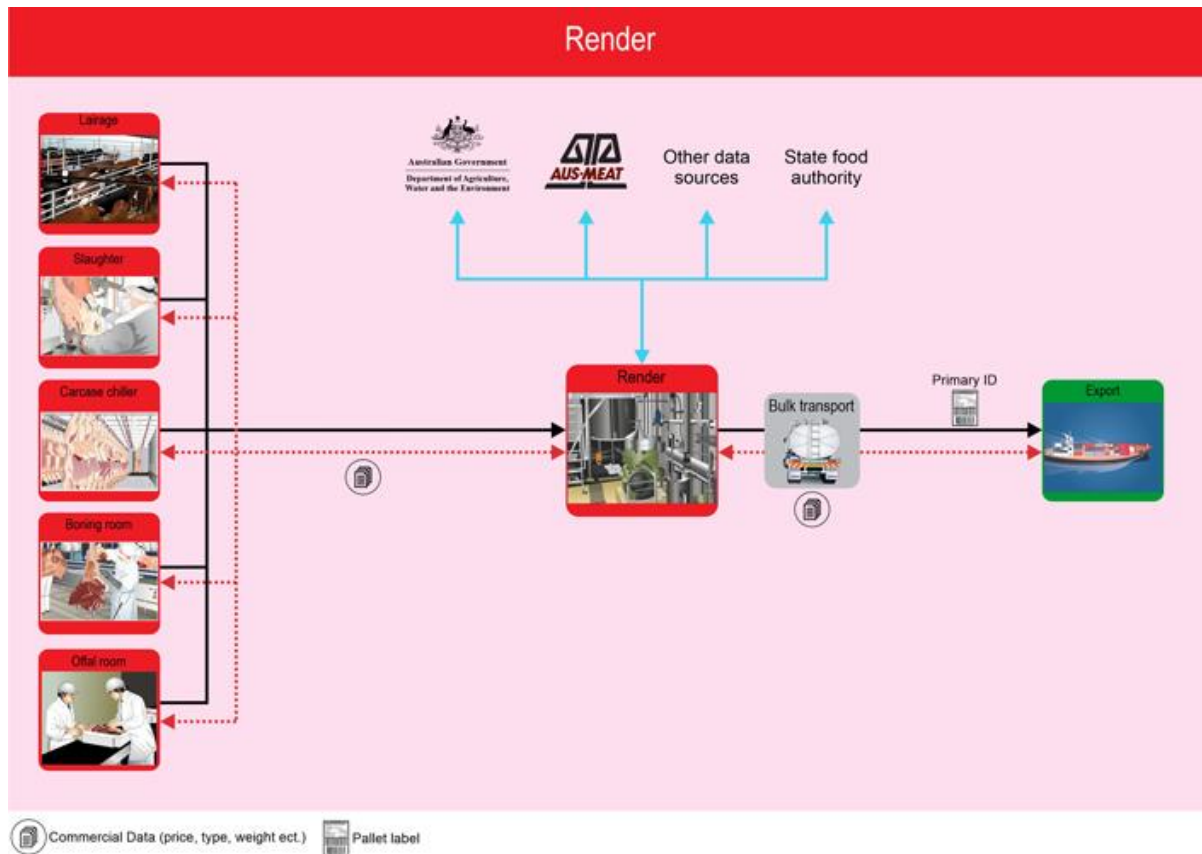

Figure 45. Inputs and outputs of the small stock supply chain render sector.

5.2.2.6.1 Physical Inputs including Critical Tracking Events (CTEs)

Physical inputs to render include carcass products unsuitable or unfit for human consumption such as condemned carcasses, condemned carcass parts, condemned offal, and cartons from carton rework.

Critical Tracking Events (CTEs) are defined as those events which include the growing, receiving, transforming, creating and shipping of food products. Such events are critical to the traceability of product throughout the supply chain.

The CTEs associated with inputs to the render system include the receipt of:

- Carton
- Condemned carcass
- Condemned carcass parts
- Condemned offal.

Table 40. Physical inputs and associated Critical Tracking Event related documents for a small stock render system.

Event related to the inputs	Description of the inputs	Critical Tracking Event (CTE) related documents (including electronic)	More details
Carton	This is a case, crate, or barrel of product.	Carton label, Official seal, Processing plant production management system	
Condemned carcass	The body of a slaughtered animal deemed unfit for human consumption. This may be a condemned dressed carcass when hide/skin, head, feet, and offal are removed.	Carcass Ticket, Processing plant production management system	
Condemned carcass parts	Any tissue or structure removed from a slaughtered animal deemed unfit for human consumption. These parts may include the head, viscera, offal, musculature, and blood. Note condemned offal is treated as a separate item here.	Processing plant production management system	
Condemned offal	Offal tissues deemed unfit for human consumption.	Processing plant production management system	

5.2.2.6.2 Information Inputs including Key Data Elements (KDEs)

Key Data Elements (KDEs) are defined as those elements which are key in identifying and tracing the Critical Tracking Event (CTE). Information inputs for render include those KDEs included on CTE documentation from condemned product. This may include carcass tickets or information recorded in the processing plants production management system.

Table 41. Information inputs, Key Data Elements and Critical Tracking Event related documentation for a small stock render system.

Attributes (including KDEs)	Description of the Attributes (including KDEs)	Is a KDE	Critical Tracking Event (CTE) related documents (including electronic)	More details
Body number	This is a number assigned to each carcass by the processor for identification purposes.	Yes	Carcass Ticket, Processing plant production management system	
Company/product code	This is an in-house code for the identification of the product in the unit.	Yes	Carton label, Processing plant production management system	

From Establishment number	A number issued by Federal and State Authorities to identify the originating site from which meat or meat products were distributed to domestic or export markets. For transfer certificates, the Establishment numbers for both the dispatching and receiving establishments are recorded.	Yes	Carcase Ticket, Carton label, Processing plant production management system	
Global Trade Item Number (GTIN)	Encoded in the GS1 barcode, the GTIN is a globally unique 14-digit number used to identify trade items, products, or services.	Yes	Carcase Ticket, Carton label, Processing plant production management system	For more information visit the GS1 website.
Lot number	A lot is a number assigned by the processor to each group of livestock consigned to slaughter and is usually vendor specific.	Yes	Carcase Ticket, Processing plant production management system	
Net Weight (Kilograms)	Usually encoded in the GS1 barcode, the Net Weight is a variable measure of the trade item e.g., carton, pallet or shipment recorded in kilograms.	Yes	Carcase Ticket, Carton label, Processing plant production management system	For more information visit the GS1 website.
Official mark	Any stamp, seal, label, or mark that is declared by the regulations to be an official mark. An official mark signifies that the product has been inspected by and approved as safe for human consumption by an Authorised Officer.	Yes	Carcase Ticket, Carton label	
Packaging Date	Encoded in the GS1 barcode, the Packaging Date is the date on which the item was packaged and is recorded in the format year, month, day (YYMMDD).	Yes	Carton label, Processing plant production management system	For more information visit the GS1 website.
Production Date (YYMMDD)	Encoded in the GS1 barcode, this is the 'kill' or slaughter' date of the product and is recorded in the format year, month, day (YYMMDD).	Yes	Carcase Ticket, Processing plant production management system	For more information visit the GS1 website.

Seal Serial Number	This is a unique serial number printed on any tamper-evident seal issued by the Department.	Yes	Official seal, Processing plant production management system	For more information visit the Australian Government Federal Register of Legislation.
Serial Number	Encoded in the GS1 barcode, this is a code, numeric or alphanumeric, assigned to an individual instance of an item for its lifetime.	Yes	Carcase Ticket, Carton label, Processing plant production management system	For more information visit the GS1 website.
Trade description	This is a collective set of words that says what the product is and may include information such as species, net weight of product, name and address of establishments, category ciphers, market endorsements, MSA eating quality etc.	Yes	Carcase Ticket, Carton label, Processing plant production management system	

5.2.2.6.3 Physical Outputs including Critical Tracking Events (CTEs)

The output of the render process is the production of by-products which can be used, stored, and sold. These by-products may include meat meal, meat and bone meal, bone meal, blood meal and tallow. Such products exit the render process packaged in store bags or are bulk transported in container system units.

Critical Tracking Events (CTEs) are defined as those events which include the growing, receiving, transforming, creating, and shipping of food products. Such events are critical to the traceability of product throughout the supply chain.

The CTEs associated with the outputs of the render system include the movement of:

- Container System Unit
- Rendered product store bag

off the property, premises, or supply chain sector.

Table 42. Physical outputs and associated Critical Tracking Event related documents for a small stock render system.

Event related to the inputs	Description of the inputs	Critical Tracking Event (CTE) related documents (including electronic)	More details
Container System Unit	A container designed for use as a unit of cargo handling equipment in the	Animal By Product Transfer Certificate (BPTC), Bill of lading/Air Waybill, Delivery Docket/Manifest, Export clearance documentation, Export Permit, Meat Messaging Consignment Report, Processing plant production management system, Receipt of purchase/Tax Invoice	

	transport of goods by aircraft or ship.		
Rendered product store bag	A large storage bag which can temporarily store large quantities of product.	Animal By Product Transfer Certificate (BPTC), Bill of lading/Air Waybill, Certificate of Analysis (COA), Delivery Docket/Manifest, Export clearance documentation, Export Permit, Processing plant production management system, Receipt of purchase/Tax Invoice, SSCC/Store bag label	

5.2.2.6.4 Information Outputs including Key Data Elements (KDEs)

Key Data Elements (KDEs) are defined as those elements which are key in identifying and tracing the Critical Tracking Event (CTE). Information outputs associated with rendered product include those derived from Critical Tracking Event related documents such as the Animal By Product Transfer Certificate (BPTC), Export clearance documentation and the Delivery Docket/Manifest.

Table 43. Information outputs, Key Data Elements and Critical Tracking Event related documentation for a small stock render system.

Attributes (including KDEs)	Description of the Attributes (including KDEs)	Is a KDE	Critical Tracking Event (CTE) related documents (including electronic)	More details
Analysis Date	This is the date on which a product sample was analysed.	Yes	Certificate of Analysis (COA), Processing plant production management system	
Bill of lading/Air Waybill document number	A unique document number issued for traceability purposes.	Yes	Bill of lading/Air Waybill, Processing plant production management system	
Certificate of Analysis number	A unique certificate number issued for traceability purposes.	Yes	Certificate of Analysis (COA), Processing plant production management system	
Company/product code	This is an in-house code for the identification of the product in the unit.	Yes	Bill of lading/Air Waybill, Certificate of Analysis (COA), Processing plant production management system, Receipt of purchase/Tax Invoice, SSCC/Store bag label	
Consignment Serial Shipping Container Code (SSCC)	Encoded in the GS1 barcode, this is a unique number which identifies the individual logistic unit i.e., shipment/message that is assigned by the establishment constructing the unit. The SSCC remains the same for the life of the logistic unit.	Yes	Animal By Product Transfer Certificate (BPTC), Bill of lading/Air Waybill, Meat Messaging Consignment Report, Processing plant production management system, SSCC/Store bag label	For more information visit the GS1 website.

Contract number	This is a unique number allocated to the contract by the seller.	Yes	Delivery Docket/Manifest, Processing plant production management system	
Count of Pallets	This is the number of pallets in the logistic unit e.g., container system unit.	Yes	Meat Messaging Consignment Report, Processing plant production management system	
Count of Trade Items	Usually encoded in the GS1 barcode, this is the number of trade items e.g., cartons in the logistic unit.	Yes	Bill of lading/Air Waybill, Delivery Docket/Manifest, Meat Messaging Consignment Report, Processing plant production management system, SSCC/Store bag label	For more information visit the GS1 website.
Date	This is the date of signing or of which a record entry or transaction was made.	Yes	Animal By Product Transfer Certificate (BPTC), Bill of lading/Air Waybill, Certificate of Analysis (COA), Delivery Docket/Manifest, Export clearance documentation, Meat Messaging Consignment Report, Processing plant production management system, Receipt of purchase/Tax Invoice	
Delivery Docket/Manifest number	This is a unique number allocated to the docket for identification purposes.	Yes	Delivery Docket/Manifest, Processing plant production management system	
Export Health Certificate Number	A unique number allocated to the health certificate issued for the export consignment for traceability purposes.	Yes	Meat Messaging Consignment Report, Processing plant production management system	For more information visit the Department of Agriculture, Water and the Environment website.
Export Permit Number	A unique permit number is allocated for the export consignment following submission of a correct and validated Request For Permit (RFP) which is then approved by the Secretary.	Yes	Export Permit, Processing plant production management system	For more information visit the Department of Agriculture, Water and the

				Environment website.
From Establishment number	A number issued by Federal and State Authorities to identify the originating site from which meat or meat products were distributed to domestic or export markets. For transfer certificates, the Establishment numbers for both the dispatching and receiving establishments are recorded.	Yes	Animal By Product Transfer Certificate (BPTC), Certificate of Analysis (COA), Delivery Docket/Manifest, Export clearance documentation, Meat Messaging Consignment Report, Processing plant production management system, SSCC/Store bag label	
Global Trade Item Number (GTIN)	Encoded in the GS1 barcode, the GTIN is a globally unique 14-digit number used to identify trade items, products, or services.	Yes	Meat Messaging Consignment Report, Processing plant production management system, SSCC/Store bag label	For more information visit the GS1 website.
GTIN of Contained Trade Items	Encoded in the GS1 barcode, the GTIN of the contained trade items is a globally unique 14-digit number used to identify trade items, products, or services in the logistic unit.	Yes	Processing plant production management system, SSCC/Store bag label	For more information visit the GS1 website.
Movement date	The date on which livestock or other products (e.g., feed or meat products) were transported between PICs/establishments.	Yes	Animal By Product Transfer Certificate (BPTC), Bill of lading/Air Waybill, Certificate of Analysis (COA), Delivery Docket/Manifest, Export clearance documentation, Processing plant production management system	
Net Weight (Kilograms)	Usually encoded in the GS1 barcode, the Net Weight is a variable measure of the trade item e.g., carton, pallet or shipment recorded in kilograms.	Yes	Bill of lading/Air Waybill, Meat Messaging Consignment Report, Processing plant production management system, SSCC/Store bag label	For more information visit the GS1 website.
Order date	This is the date on which the purchase order or contract was raised by the buyer.	Yes	Delivery Docket/Manifest, Processing plant production management system	
Packaging Date	Encoded in the GS1 barcode, the Packaging Date is the date on which the item was packaged and is recorded in the format year, month, day (YYMMDD).	Yes	Certificate of Analysis (COA), Processing plant production management system, SSCC/Store bag label	For more information visit the GS1 website.

Packaging Date Range	This includes the oldest and newest packaging dates for the logistic unit.	Yes	Export clearance documentation, Processing plant production management system, SSCC/Store bag label	For more information visit the GS1 website.
Pallet Serial Shipping Container Code (SSCC)	Encoded in the GS1 barcode, this is a unique number which identifies the individual logistic unit i.e., pallet that is assigned by the establishment constructing the unit. The SSCC remains the same for the life of the logistic unit.	Yes	Animal By Product Transfer Certificate (BPTC), Export clearance documentation, Meat Messaging Consignment Report, Processing plant production management system, SSCC/Store bag label	For more information visit the GS1 website.
Producer/Vendor MSA Registration Number	Producers consigning livestock to MSA markets are required to be registered and have a unique MSA Registration Number.	Yes	Processing plant production management system	
Production Date (YYMMDD)	Encoded in the GS1 barcode, this is the 'kill' or slaughter' date of the product and is recorded in the format year, month, day (YYMMDD).	Yes	Animal By Product Transfer Certificate (BPTC)	For more information visit the GS1 website.
Recipient Australian Business Number (ABN)	This is an 11-digit registration number, issued by the Australian Tax Office, used to identify businesses.	Yes	Processing plant production management system, Receipt of purchase/Tax Invoice	For more information visit the ATO website.
Seal Serial Number	This is a unique serial number printed on any tamper-evident seal issued by the Department.	Yes	Animal By Product Transfer Certificate (BPTC), Bill of lading/Air Waybill, Export clearance documentation, Processing plant production management system	For more information visit the Australian Government Federal Register of Legislation.
Seller/Supplier Australian Business Number (ABN)	This is an 11-digit registration number, issued by the Australian Tax Office, used to identify businesses.	Yes	Processing plant production management system, Receipt of purchase/Tax Invoice	For more information visit the ATO website.
Shipping Mark	Also known as a port mark, this is a code comprising of three letters representing the foreign establishment number and the last nine digits of the consignment SSCC.	Yes	Bill of lading/Air Waybill, Certificate of Analysis (COA), Delivery Docket/Manifest, Meat Messaging Consignment Report, Processing plant production management system, SSCC/Store bag label	

To Establishment number	A number issued by Federal and State Authorities to identify the originating site from which meat or meat products were distributed to domestic or export markets. For transfer certificates, the Establishment numbers for both the dispatching and receiving establishments are recorded.	Yes	Animal By Product Transfer Certificate (BPTC), Export clearance documentation, Processing plant production management system	
Trade description	This is a collective set of words that says what the product is and may include information such as species, net weight of product, name and address of establishments, category ciphers, market endorsements, MSA eating quality etc.	Yes	Animal By Product Transfer Certificate (BPTC), Delivery Docket/Manifest, Export clearance documentation, Meat Messaging Consignment Report, Processing plant production management system, SSCC/Store bag label	
Transfer Certificate number	A unique certificate number issued for traceability purposes.	Yes	Animal By Product Transfer Certificate (BPTC), Meat Messaging Consignment Report, Processing plant production management system	
Transport registration number	The registration number of the vehicle in which the animals or product were transported. For shipments of product this will be a shipping container number.	Yes	Animal By Product Transfer Certificate (BPTC), Bill of lading/Air Waybill, Delivery Docket/Manifest, Export clearance documentation, Meat Messaging Consignment Report, Processing plant production management system	

5.2.2.6.5 Regulatory and Industry Programs

- Department of Agriculture
- AUS-MEAT
- Australian Renderers Association (ARA)
- State food authority
- Other data sources

5.2.2.6.6 Supply Chain Node Traceability

The traceability of rendered and hide product back to the live animal, or consignment group and property of origin is operationally impractical. This is because rendered and hide products are bulk processed and packaged from any given processing day or number of processing days. While this means that the production date or kill date of animals from which hides or rendered product is likely to be known, any batch of product being packaged into store bags or pallets with unique serialised labels is only traceable to any number of source properties.

For example, skins or product for render which make up one batch may come from a total of 6 plant kill day combinations. For each processing day 4 000 animals, sourced from 10 different properties are slaughtered and the unique serialised NLIS ID tag numbers, or PICs known for each animal as well as that of the corresponding carcass ticket. With render or skin products from these processing days being processed and packaged in one batch, the unique serialised identifiers of output products can be linked only to that batch and the processing dates from which product was obtained. This means that one batch is comprised of any of 24 000 source animals that were supplied by a maximum of any of 60 potential source properties.

5.2.2.6.7 Data flow diagrams

Table 44. Data flow diagrams for the inputs and outputs of a small stock render system.

Direction	Description
Input	Lairage to Render - condemns and dead on arrival/ in pen
Input	Slaughter floor to Render - hides/skins
Input	Slaughter floor to Render - not fit for human consumption (red bin)
Input	Offal room to Render
Input	Boning room to Render
Input	Carton rework to Render
Output	Render (meat/ bone meal) to Render loadout
Output	Render (tallow) to Render loadout

5.2.2.6.7.1 Lairage to Render - condemns and dead-on arrival/ in pen

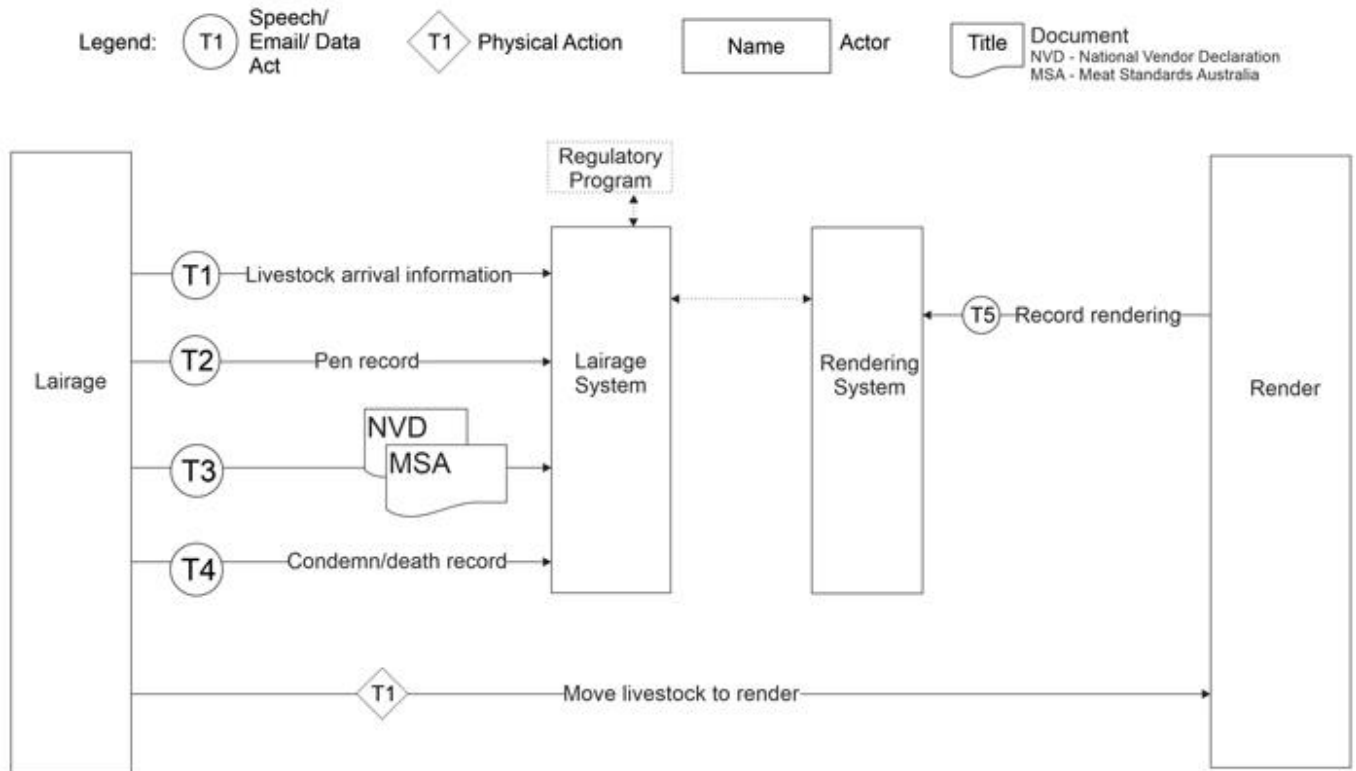

Lairage to Render - Condemns and Dead on arrival/ in pen

Figure 46. Data or information flows from the lairage to render (condemns and dead on arrival) systems in the small stock supply chain.

5.2.2.6.7.2 Slaughter floor to Render - hides/skins

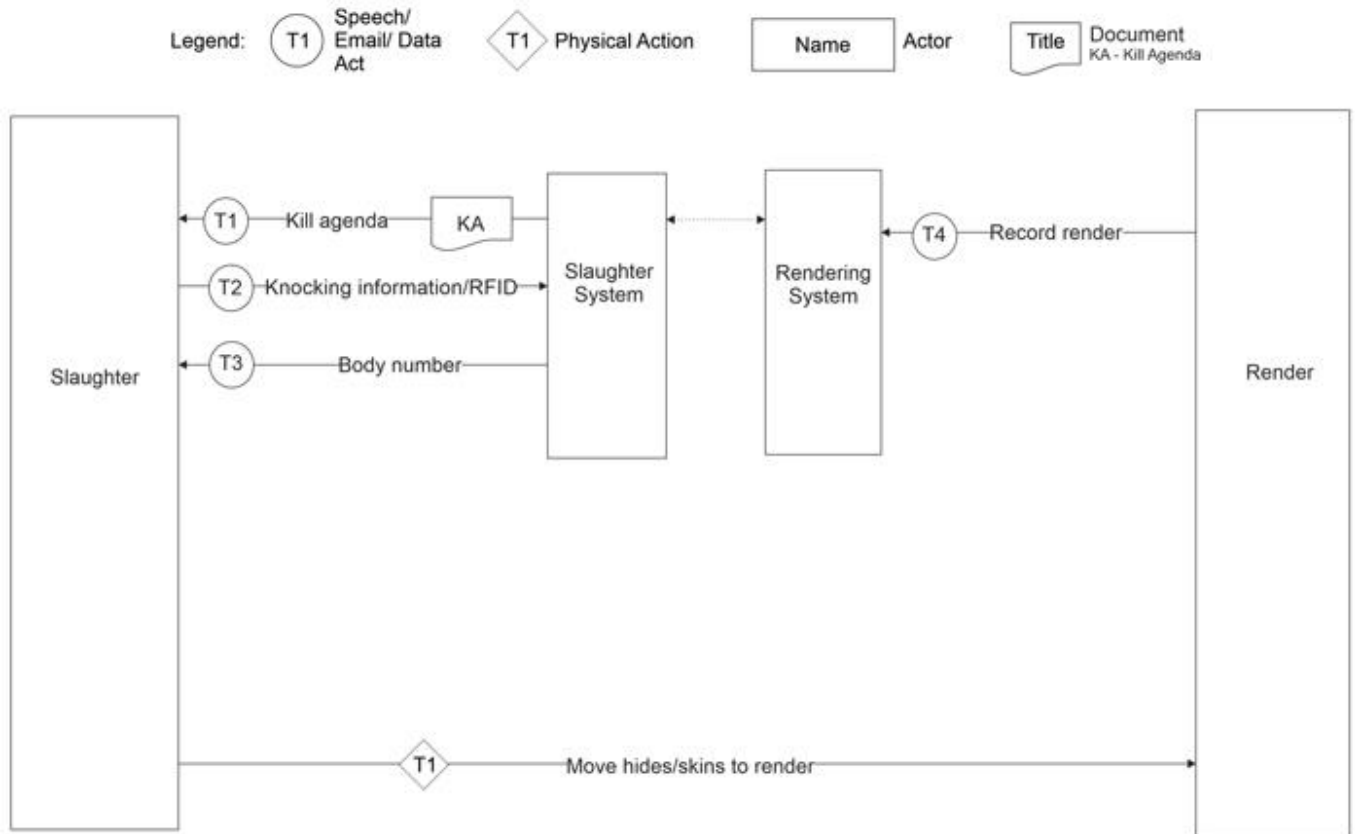

Slaughter to Render -Hides/Skins

Figure 47. Data or information flows from the slaughter to render (hides/skins) systems in the small stock supply chain.

5.2.2.6.7.3 Slaughter floor to Render - not fit for human consumption (red bin)

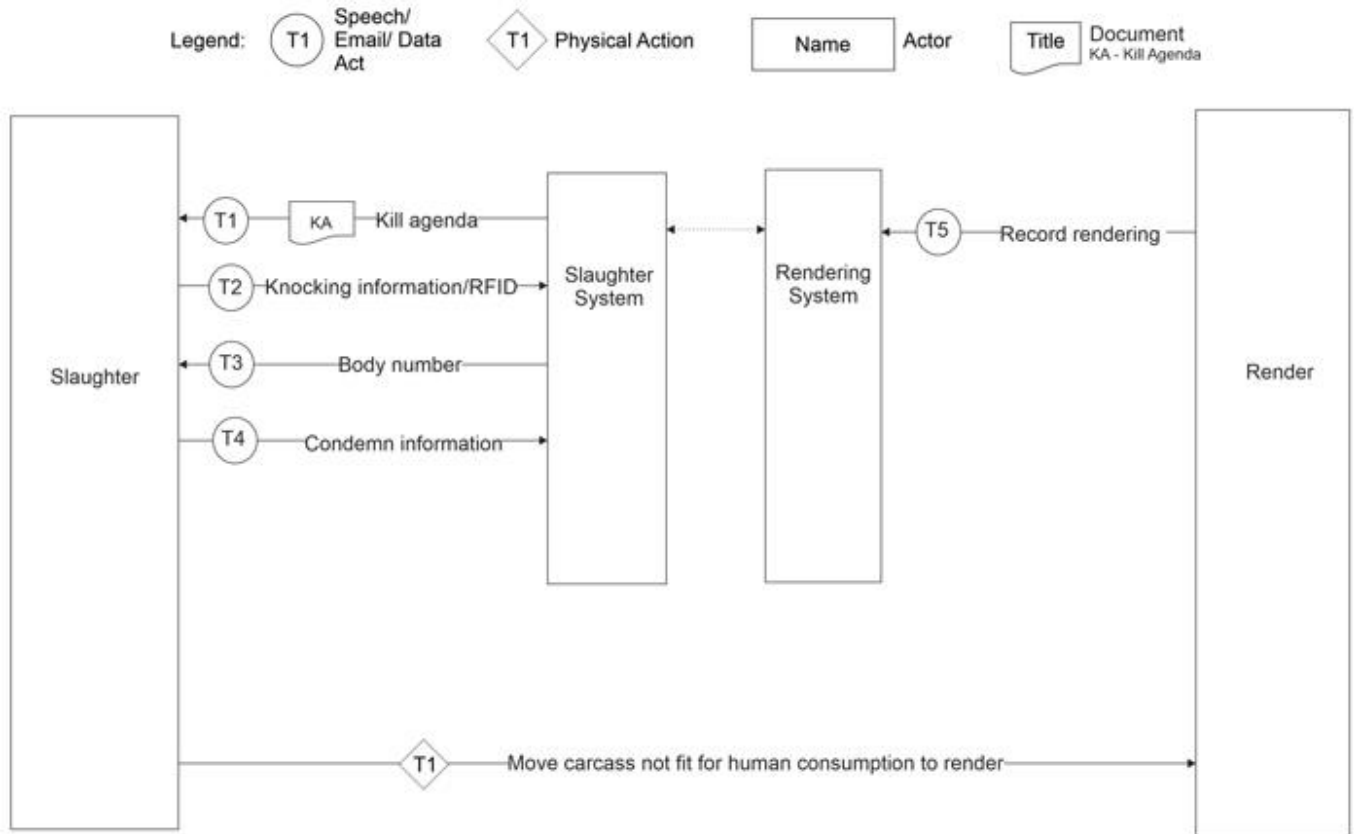

Slaughter to Render-Not Fit for Human Consumption

Figure 48. Data or information flows from the slaughter to render (not fit for human consumption) systems in the small stock supply chain.

5.2.2.6.7.4 Offal room to Render

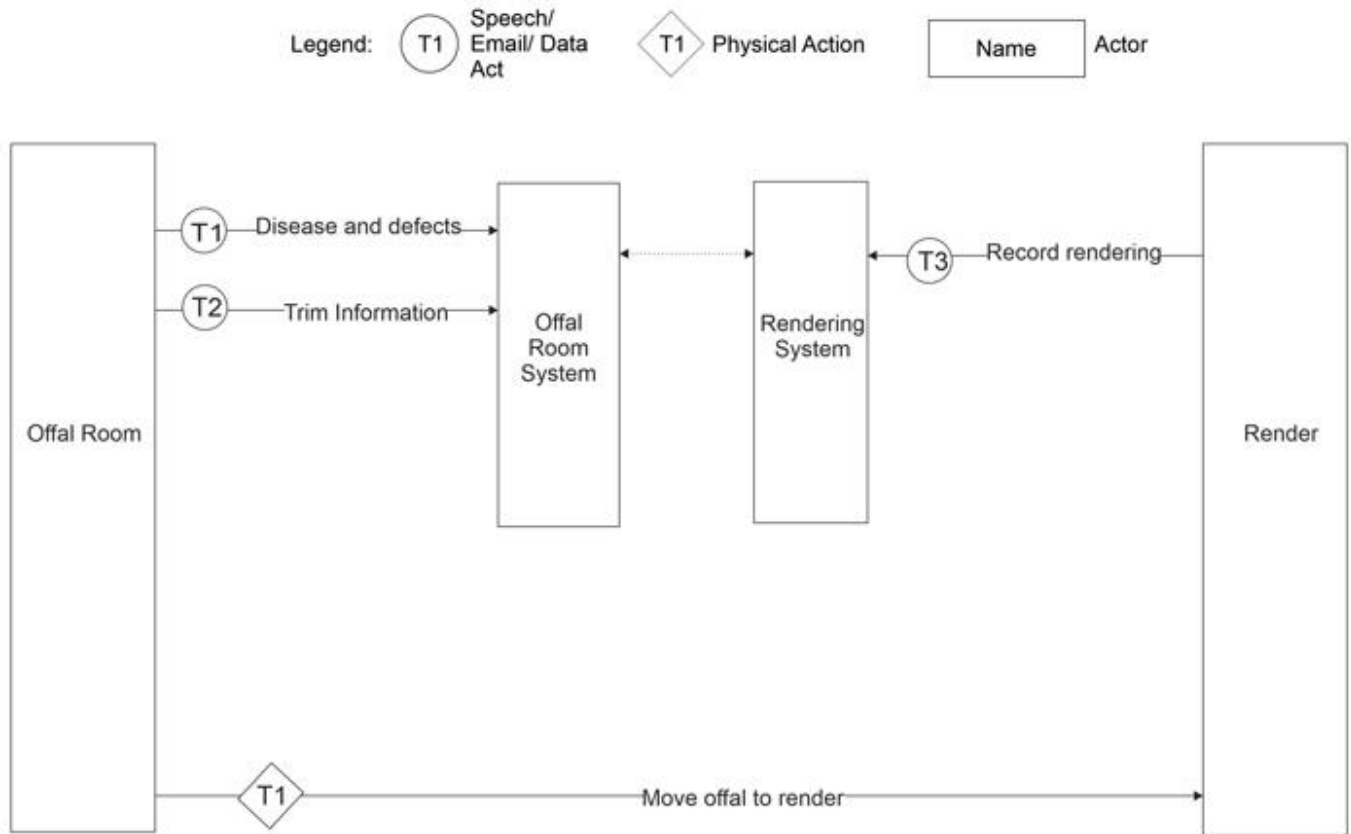

Offal Room to Render

Figure 49. Data or information flows from the offal room to render systems in the small stock supply chain.

5.2.2.6.7.5 Boning room to Render

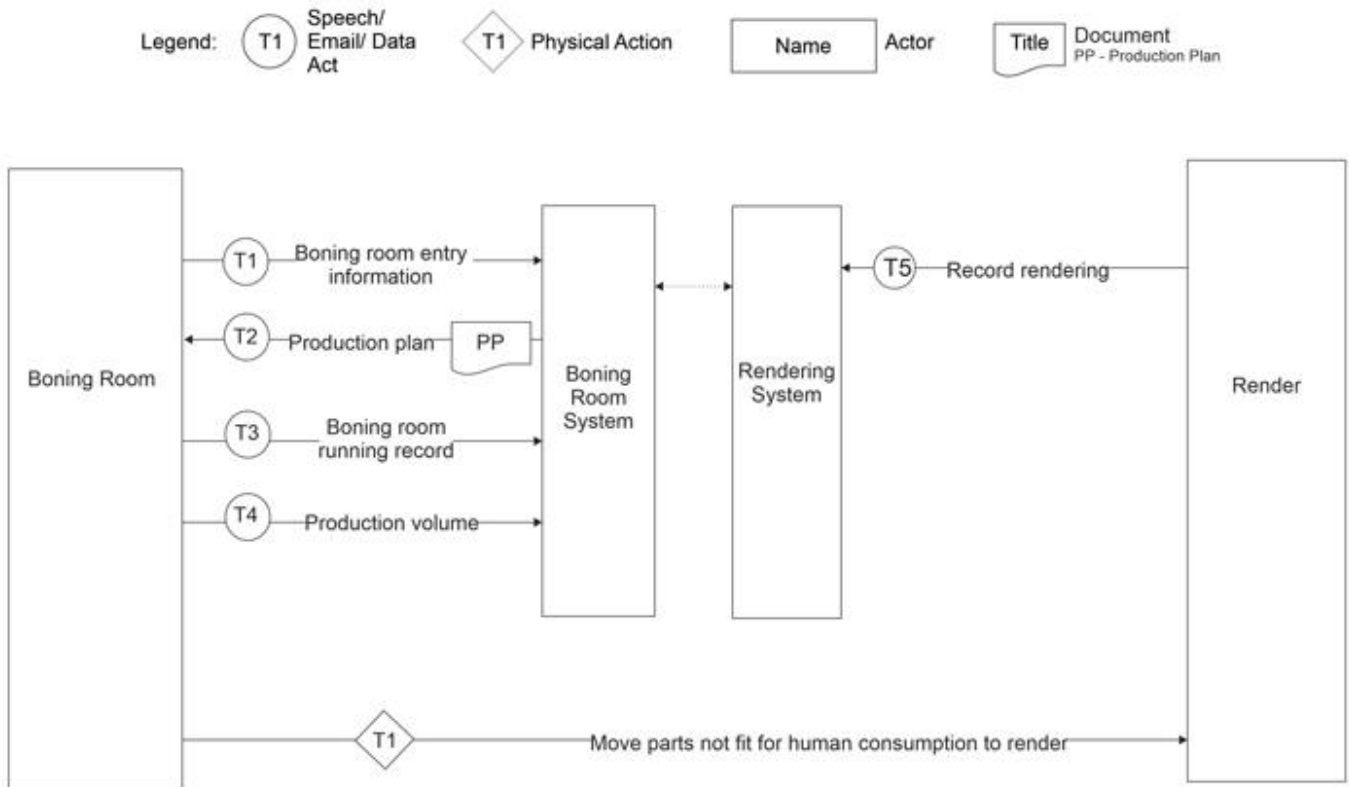

Boning Room to Render

Figure 50. Data or information flows from the boning room to render systems in the small stock supply chain.

5.2.2.6.7.6 Carton rework to Render

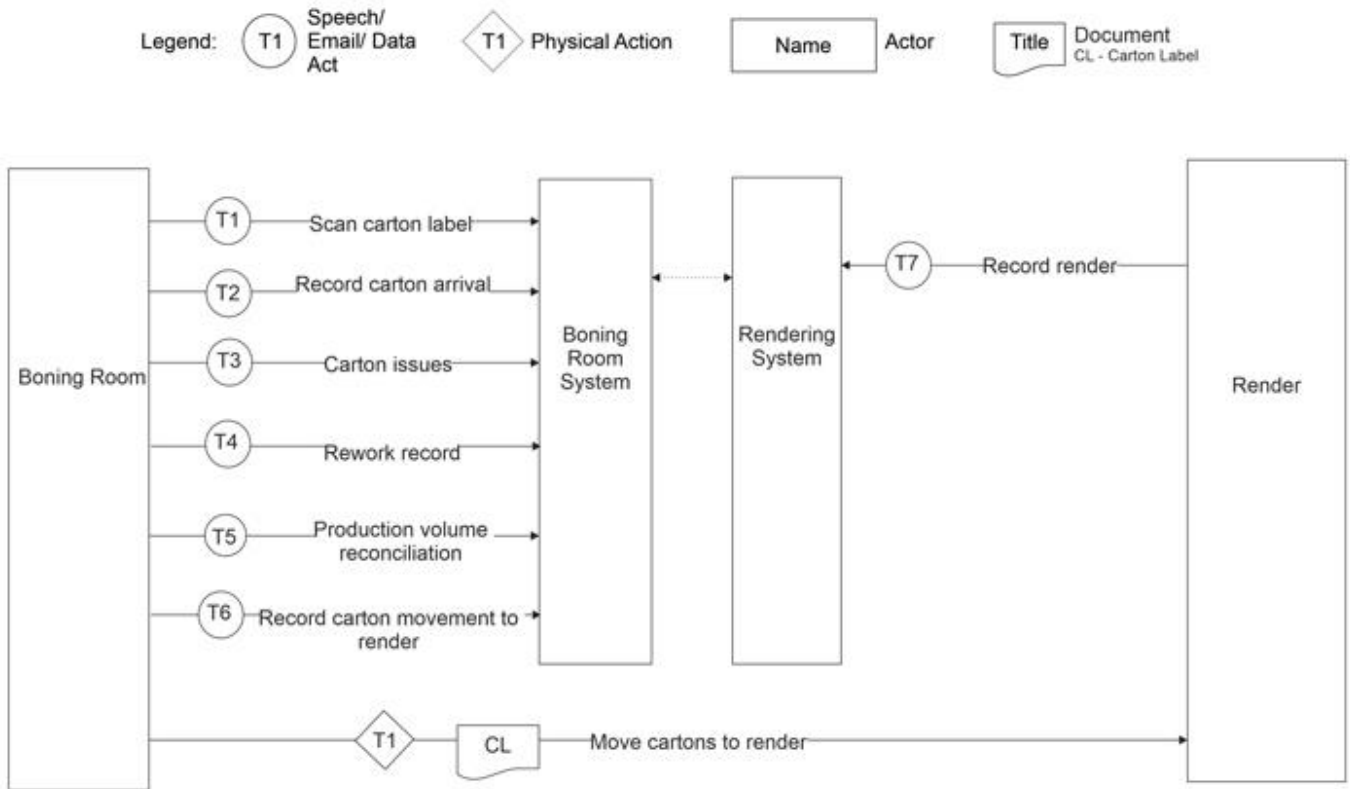

Carton Rework to Render

Figure 51. Data or information flows from the carton rework to render systems in the small stock supply chain.

5.2.2.6.7.7 Render (meat/ bone meal) to Render loadout

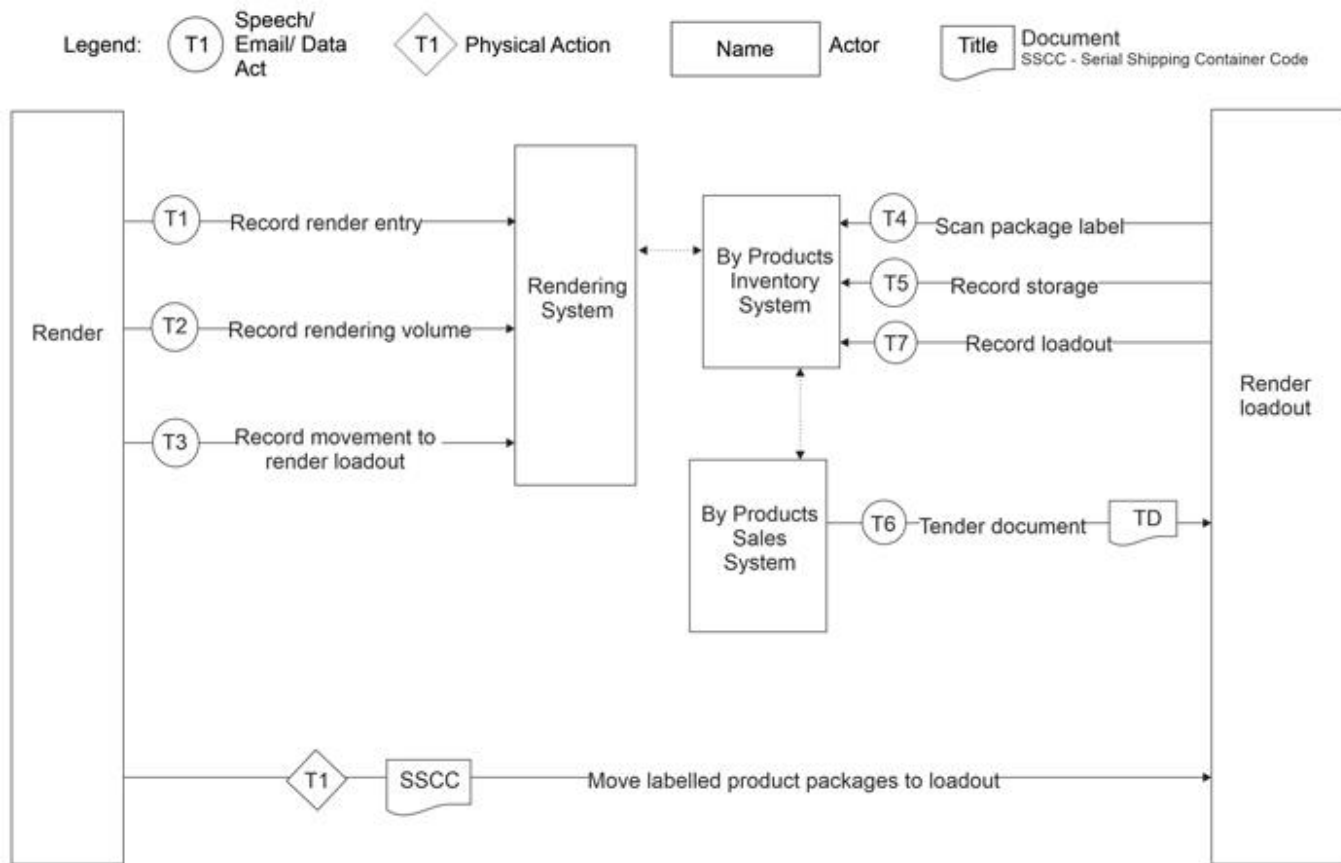

Render (meat/bone meal) to Render Loadout

Figure 52. Data or information flows from the render (meat/bone meal) to render loadout systems in the small stock supply chain.

5.2.2.6.7.8 Render (tallow) to Render loadout

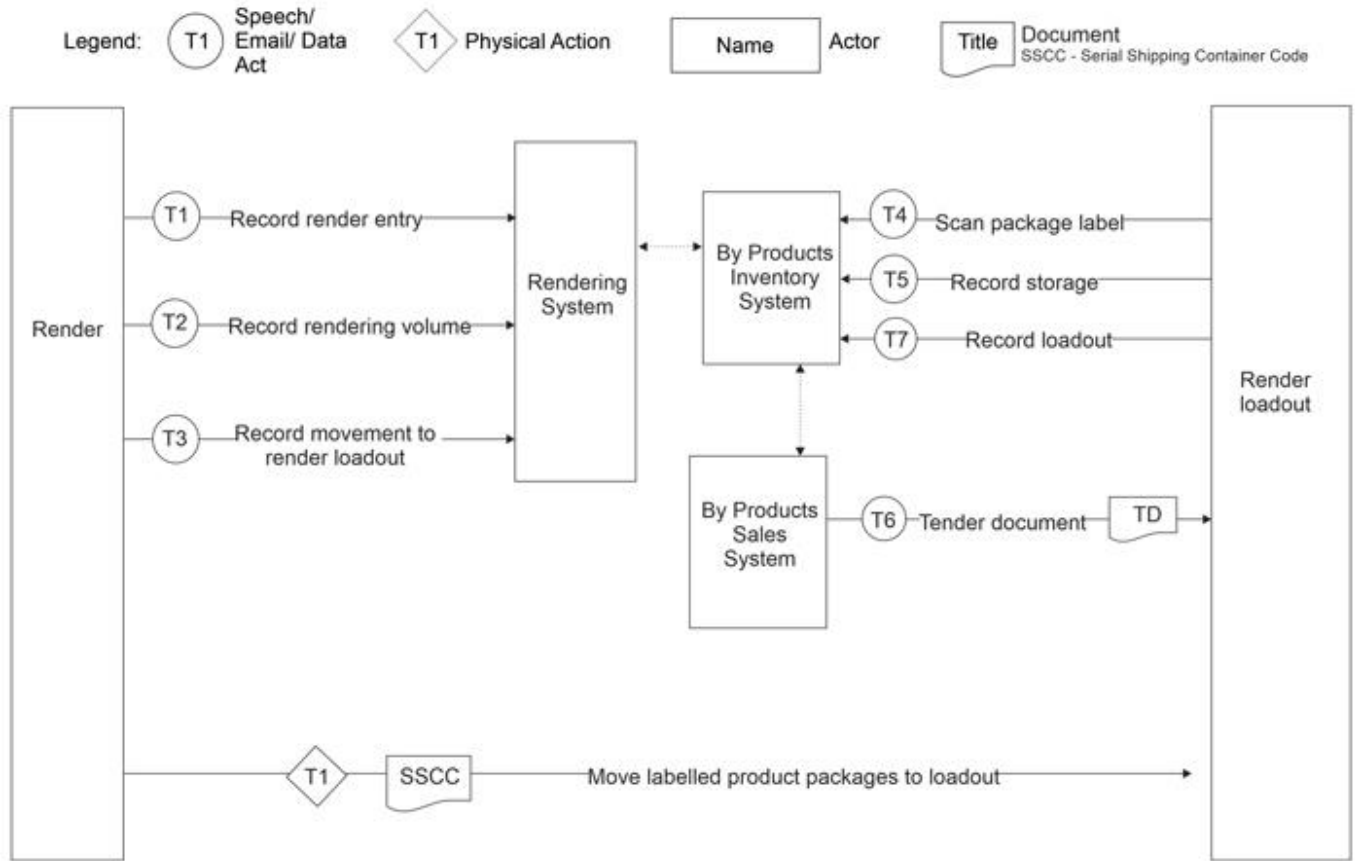

Render (tallow) to Render Loadout

Figure 53. Data or information flows from the render (tallow) to render loadout systems in the small stock supply chain.

5.2.2.7 Fleece

Hide and skin (fleece) processing is the location at the processing plant whereby hides and skins are prepared for export. This involves the trimming of raw materials to exclude internal organs, bone, and hoof as well as the preservation and treatment for insects and bacteria where required. Hides and skins are then packed to ensure the hygienic transportation of products to export markets.

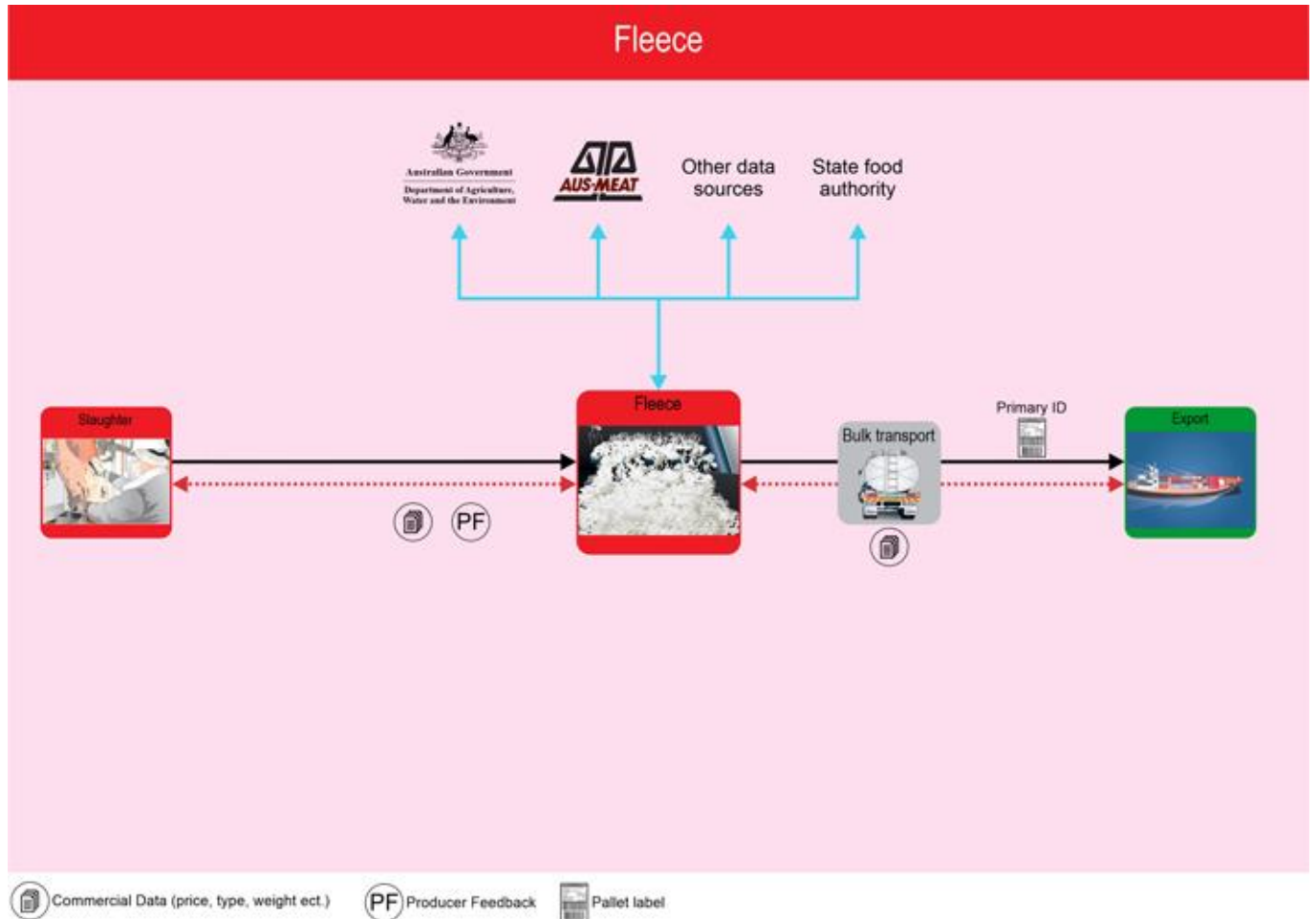

Figure 54. Inputs and outputs of the small stock supply chain fleece sector.

5.2.2.7.1 Physical Inputs including Critical Tracking Events (CTEs)

Once the skin is removed, it goes through various stages of processing before it is sold. Therefore, the inputs into the skin or fleece production system include the hide/skin, derived from slaughtered livestock, as well as hide/skin additives. Such additives are used for the treatment of hides before sale and may include products such as salt.

Critical Tracking Events (CTEs) are defined as those events which include the growing, receiving, transforming, creating, and shipping of food products. Such events are critical to the traceability of product throughout the supply chain.

The CTEs associated with inputs to the fleece system include the receipt of:

- Hide/Skin
- Hide/Skin additives.

Table 45. Physical inputs and associated Critical Tracking Event related documents for a small stock fleece system.

Event related to the inputs	Description of the inputs	Critical Tracking Event (CTE) related documents (including electronic)	More details
Hide/Skin	Processing plant production management system	The pelt of the animal. Typically referred to as 'hide' for larger animals e.g., cattle and 'skin' for smaller animals e.g., sheep, calves.	
Hide/Skin additives	Materials used in treatment of hides/skins for preservation purposes e.g., salt.	Processing plant production management system, Receipt of purchase/Tax Invoice	

5.2.2.7.2 Information Inputs including Key Data Elements (KDEs)

Key Data Elements (KDEs) are defined as those elements which are key in identifying and tracing the Critical Tracking Event (CTE). Information inputs into the hide/skin production system are those which are found in the processors production management system and include basic product information such as establishment number and production date.

Table 46. Information inputs, Key Data Elements and Critical Tracking Event related documentation for a small stock fleece system.

Attributes (including KDEs)	Description of the Attributes (including KDEs)	Is a KDE	Critical Tracking Event (CTE) related documents (including electronic)	More details
Batch number	This is a unique number which identifies products sharing certain production characteristics and is used for traceability purposes.	Yes	Processing plant production management system	
Company/product code	This is an in-house code for the identification of the product in the unit.	Yes	Processing plant production management system, Receipt of purchase/Tax Invoice	
Date	This is the date of signing or of which a record entry or transaction was made.	Yes	Processing plant production management system, Receipt of purchase/Tax Invoice	
From Establishment number	A number issued by Federal and State Authorities to identify the originating site from which meat or meat products were distributed to domestic or export markets. For transfer certificates, the Establishment numbers for both the dispatching and receiving establishments are recorded.	Yes	Processing plant production management system	
Production Date (YYMMDD)	Encoded in the GS1 barcode, this is the 'kill' or slaughter' date of the product and is recorded in the format year, month, day (YYMMDD).	Yes	Processing plant production	For more information visit the

			management system	GS1 website.
Recipient Australian Business Number (ABN)	This is an 11-digit registration number, issued by the Australian Tax Office, used to identify businesses.	Yes	Processing plant production management system, Receipt of purchase/Tax Invoice	For more information visit the ATO website.
Seller/Supplier Australian Business Number (ABN)	This is an 11-digit registration number, issued by the Australian Tax Office, used to identify businesses.	Yes	Processing plant production management system, Receipt of purchase/Tax Invoice	For more information visit the ATO website.
Treatment date	The date on which a treatment or product was applied to a unit e.g., paddock, animal, fodder etc.	Yes	Processing plant production management system	

5.2.2.7.3 Physical Outputs including Critical Tracking Events (CTEs)

Physical outputs of the hide/skin production system are treated skins which are loaded onto pallets or into container system units for transport and sale.

Critical Tracking Events (CTEs) are defined as those events which include the growing, receiving, transforming, creating, and shipping of food products. Such events are critical to the traceability of product throughout the supply chain.

The CTEs associated with the outputs of the fleece system include the movement of:

- Container System Unit
- Pallet

off the property, premises, or supply chain sector.

Table 47. Physical outputs and associated Critical Tracking Event related documents for a small stock fleece system.

Event related to the inputs	Description of the inputs	Critical Tracking Event (CTE) related documents (including electronic)	More details
Container System Unit	A container designed for use as a unit of cargo handling equipment in the transport of goods by aircraft or ship.	Animal By Product Transfer Certificate (BPTC), Bill of lading/Air Waybill, Delivery Docket/Manifest, Export clearance documentation, Export Permit, Meat Messaging Consignment Report, Processing plant production management system, Receipt of purchase/Tax Invoice	
Pallet	A logistic unit which includes a number of cartons or goods items packed together for	Animal By Product Transfer Certificate (BPTC), Bill of lading/Air Waybill, Certificate of Analysis (COA), Delivery Docket/Manifest, Export clearance documentation, Export	

	transport or storage purposes.	Permit, Processing plant production management system, Receipt of purchase/Tax Invoice, SSCC/Pallet label	
--	--------------------------------	---	--

5.2.2.7.4 Information Outputs including Key Data Elements (KDEs)

Key Data Elements (KDEs) are defined as those elements which are key in identifying and tracing the Critical Tracking Event (CTE). Information outputs from the hide/skin production system can be found on the pallet label and on container system unit documentation, as well as other sale/transport documentation. This information is stored in the processors production management system for traceability. Such information includes application identifiers included in the GS1 barcode as well as trade description information.

Table 48. Information outputs, Key Data Elements and Critical Tracking Event related documentation for a small stock fleece system.

Attributes (including KDEs)	Description of the Attributes (including KDEs)	Is a KDE	Critical Tracking Event (CTE) related documents (including electronic)	More details
Analysis Date	This is the date on which a product sample was analysed.	Yes	Certificate of Analysis (COA), Processing plant production management system	
Bill of lading/Air Waybill document number	A unique document number issued for traceability purposes.	Yes	Bill of lading/Air Waybill, Processing plant production management system	
Certificate of Analysis number	A unique certificate number issued for traceability purposes.	Yes	Certificate of Analysis (COA), Processing plant production management system	
Company/product code	This is an in-house code for the identification of the product in the unit.	Yes	Bill of lading/Air Waybill, Certificate of Analysis (COA), Processing plant production management system, Receipt of purchase/Tax Invoice, SSCC/Pallet label	
Consignment Serial Shipping Container Code (SSCC)	Encoded in the GS1 barcode, this is a unique number which identifies the individual logistic unit i.e., shipment/message that is assigned by the establishment constructing the unit. The SSCC remains the same for the life of the logistic unit.	Yes	Animal By Product Transfer Certificate (BPTC), Bill of lading/Air Waybill, Export clearance documentation, Meat Messaging Consignment Report, Processing plant production management system, SSCC/Pallet label	For more information visit the GS1 website.
Contract number	This is a unique number allocated to the contract by the seller.	Yes	Delivery Docket/Manifest, Processing plant production management system	
Count of Pallets	This is the number of pallets in the logistic unit e.g., container system unit.	Yes	Meat Messaging Consignment Report	
Count of Trade Items	Usually encoded in the GS1 barcode, this is the number of trade items e.g., cartons in the logistic unit.	Yes	Bill of lading/Air Waybill, Delivery Docket/Manifest, Meat Messaging Consignment Report, Processing plant production management system, SSCC/Pallet label	For more information visit the GS1 website.

Date	This is the date of signing or of which a record entry or transaction was made.	Yes	Animal By Product Transfer Certificate (BPTC), Bill of lading/Air Waybill, Certificate of Analysis (COA), Delivery Docket/Manifest, Export clearance documentation, Meat Messaging Consignment Report, Processing plant production management system, Receipt of purchase/Tax Invoice	
Delivery Docket/Manifest number	This is a unique number allocated to the docket for identification purposes.	Yes	Delivery Docket/Manifest, Processing plant production management system	
Export Health Certificate Number	A unique number allocated to the health certificate issued for the export consignment for traceability purposes.	Yes	Meat Messaging Consignment Report, Processing plant production management system	For more information visit the Department of Agriculture, Water and the Environment website.
Export Permit Number	A unique permit number is allocated for the export consignment following submission of a correct and validated Request For Permit (RFP) which is then approved by the Secretary.	Yes	Export Permit, Processing plant production management system	For more information visit the Department of Agriculture, Water and the Environment website.
From Establishment number	A number issued by Federal and State Authorities to identify the originating site from which meat or meat products were distributed to domestic or export markets. For transfer certificates, the Establishment numbers for both the dispatching and receiving establishments are recorded.	Yes	Animal By Product Transfer Certificate (BPTC), Certificate of Analysis (COA), Delivery Docket/Manifest, Export clearance documentation, Meat Messaging Consignment Report, Processing plant production management system, SSCC/Pallet label	
Global Trade Item Number (GTIN)	Encoded in the GS1 barcode, the GTIN is a globally unique 14-digit number used to identify trade items, products, or services.	Yes	Meat Messaging Consignment Report, Processing plant production management system, SSCC/Pallet label	For more information visit the GS1 website.
GTIN of Contained Trade Items	Encoded in the GS1 barcode, the GTIN of the contained trade items is a globally unique 14-digit number used to identify trade items, products, or services in the logistic unit.	Yes	Processing plant production management system, SSCC/Pallet label	For more information visit the GS1 website.
Movement date	The date on which livestock or other products (e.g., feed or meat products) were transported between PICs/establishments.	Yes	Animal By Product Transfer Certificate (BPTC), Bill of lading/Air Waybill, Certificate of Analysis (COA), Delivery Docket/Manifest, Export clearance documentation,	

			Processing plant production management system	
Net Weight (Kilograms)	Usually encoded in the GS1 barcode, the Net Weight is a variable measure of the trade item e.g., carton, pallet or shipment recorded in kilograms.	Yes	Bill of lading/Air Waybill, Meat Messaging Consignment Report, Processing plant production management system, SSCC/Pallet label	For more information visit the GS1 website.
Official mark	Any stamp, seal, label, or mark that is declared by the regulations to be an official mark. An official mark signifies that the product has been inspected by and approved as safe for human consumption by an Authorised Officer.	Yes	SSCC/Pallet label	
Order date	This is the date on which the purchase order or contract was raised by the buyer.	Yes	Delivery Docket/Manifest, Processing plant production management system	
Packaging Date	Encoded in the GS1 barcode, the Packaging Date is the date on which the item was packaged and is recorded in the format year, month, day (YYMMDD).	Yes	Certificate of Analysis (COA), Processing plant production management system, SSCC/Pallet label	For more information visit the GS1 website.
Packaging Date Range	This includes the oldest and newest packaging dates for the logistic unit.	Yes	Export clearance documentation, Processing plant production management system, SSCC/Pallet label	For more information visit the GS1 website.
Pallet Serial Shipping Container Code (SSCC)	Encoded in the GS1 barcode, this is a unique number which identifies the individual logistic unit i.e., pallet that is assigned by the establishment constructing the unit. The SSCC remains the same for the life of the logistic unit.	Yes	Animal By Product Transfer Certificate (BPTC), Export clearance documentation, Meat Messaging Consignment Report, Processing plant production management system, SSCC/Pallet label	For more information visit the GS1 website.
Production Date (YYMMDD)	Encoded in the GS1 barcode, this is the 'kill' or slaughter' date of the product and is recorded in the format year, month, day (YYMMDD).	Yes	Animal By Product Transfer Certificate (BPTC), Processing plant production management system	For more information visit the GS1 website.
Recipient Australian Business Number (ABN)	This is an 11-digit registration number, issued by the Australian Tax Office, used to identify businesses.	Yes	Processing plant production management system, Receipt of purchase/Tax Invoice	For more information visit the ATO website.
Seal Serial Number	This is a unique serial number printed on any tamper-evident seal issued by the Department.	Yes	Animal By Product Transfer Certificate (BPTC), Bill of lading/Air Waybill, Export clearance documentation, Processing plant production management system	For more information visit the Australian Government Federal Register of Legislation.
Seller/Supplier Australian Business Number (ABN)	This is an 11-digit registration number, issued by the Australian Tax Office, used to identify businesses.	Yes	Processing plant production management system, Receipt of purchase/Tax Invoice	For more information visit the ATO website.

Shipping Mark	Also known as a port mark, this is a code comprising of three letters representing the foreign establishment number and the last nine digits of the consignment SSCC.	Yes	Bill of lading/Air Waybill, Certificate of Analysis (COA), Delivery Docket/Manifest, Meat Messaging Consignment Report, Processing plant production management system, SSCC/Pallet label	
To Establishment number	A number issued by Federal and State Authorities to identify the originating site from which meat or meat products were distributed to domestic or export markets. For transfer certificates, the Establishment numbers for both the dispatching and receiving establishments are recorded.	Yes	Animal By Product Transfer Certificate (BPTC), Export clearance documentation, Processing plant production management system	
Trade description	This is a collective set of words that says what the product is and may include information such as species, net weight of product, name and address of establishments, category ciphers, market endorsements, MSA eating quality etc.	Yes	Animal By Product Transfer Certificate (BPTC), Delivery Docket/Manifest, Export clearance documentation, Meat Messaging Consignment Report, Processing plant production management system, SSCC/Pallet label	
Transfer Certificate number	A unique certificate number issued for traceability purposes.	Yes	Animal By Product Transfer Certificate (BPTC), Meat Messaging Consignment Report, Processing plant production management system	
Transport registration number	The registration number of the vehicle in which the animals or product were transported. For shipments of product this will be a shipping container number.	Yes	Animal By Product Transfer Certificate (BPTC), Bill of lading/Air Waybill, Delivery Docket/Manifest, Export clearance documentation, Meat Messaging Consignment Report, Processing plant production management system	

5.2.2.7.5 Regulatory and Industry Programs

- Department of Agriculture
- AUS-MEAT
- Australian Hides Skin and Leather Exporters Association (AHSLEA)
- State food authority
- Other data sources

5.2.2.7.6 Supply Chain Node Traceability

The traceability of rendered and hide product back to the live animal, or consignment group and property of origin is operationally impractical. This is because rendered and hide products are bulk processed and packaged from any given processing day or number of processing days. While this means that the production date or kill date of animals from which hides or rendered product is likely to be known, any batch of product being packaged into store bags or pallets with unique serialised labels is only traceable to any number of source properties.

For example, skins or product for render which make up one batch may come from a total of 6 plant kill day combinations. For each processing day 4 000 animals, sourced from 10 different properties are slaughtered and the unique serialised NLIS ID tag numbers, or PICs known for each animal as well as that of the corresponding carcass ticket. With render or skin products from these processing days being processed and packaged in one batch, the unique serialised identifiers of output products can be linked only to that batch and the processing dates from which product was obtained. This means that one batch is comprised of any of 24 000 source animals that were supplied by a maximum of any of 60 potential source properties.

5.2.2.7.7 Data flow diagrams

Table 49. Data flow diagrams for the inputs and outputs of a small stock fleece system.

Direction	Description
Input	Slaughter floor to Fleece
Output	Fleece to Bulk loadout

5.2.2.7.7.1 Slaughter floor to Fleece/Render

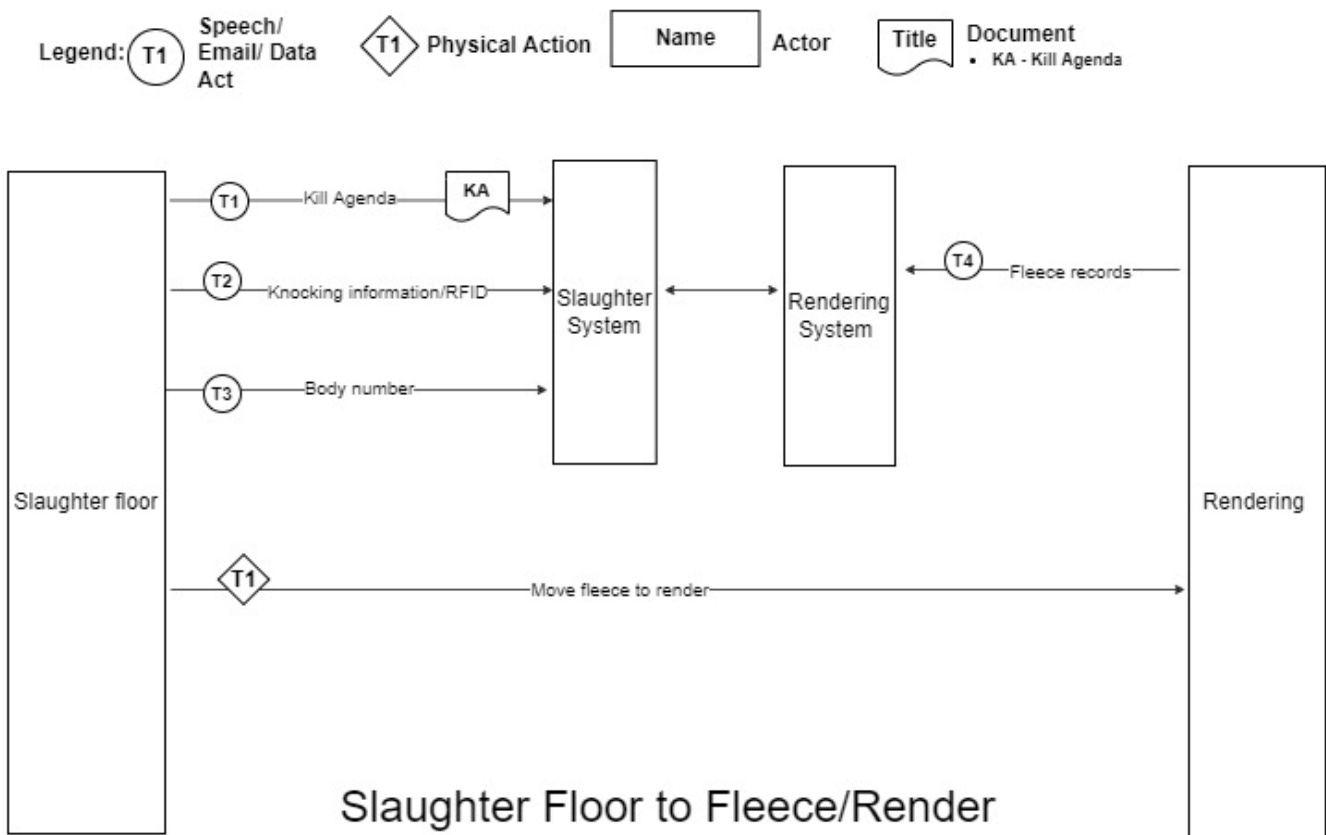

Figure 55. Data or information flows from the slaughter floor to fleece/render loadout systems in the small stock supply chain.

5.2.2.7.7.2 Fleece to Bulk loadout

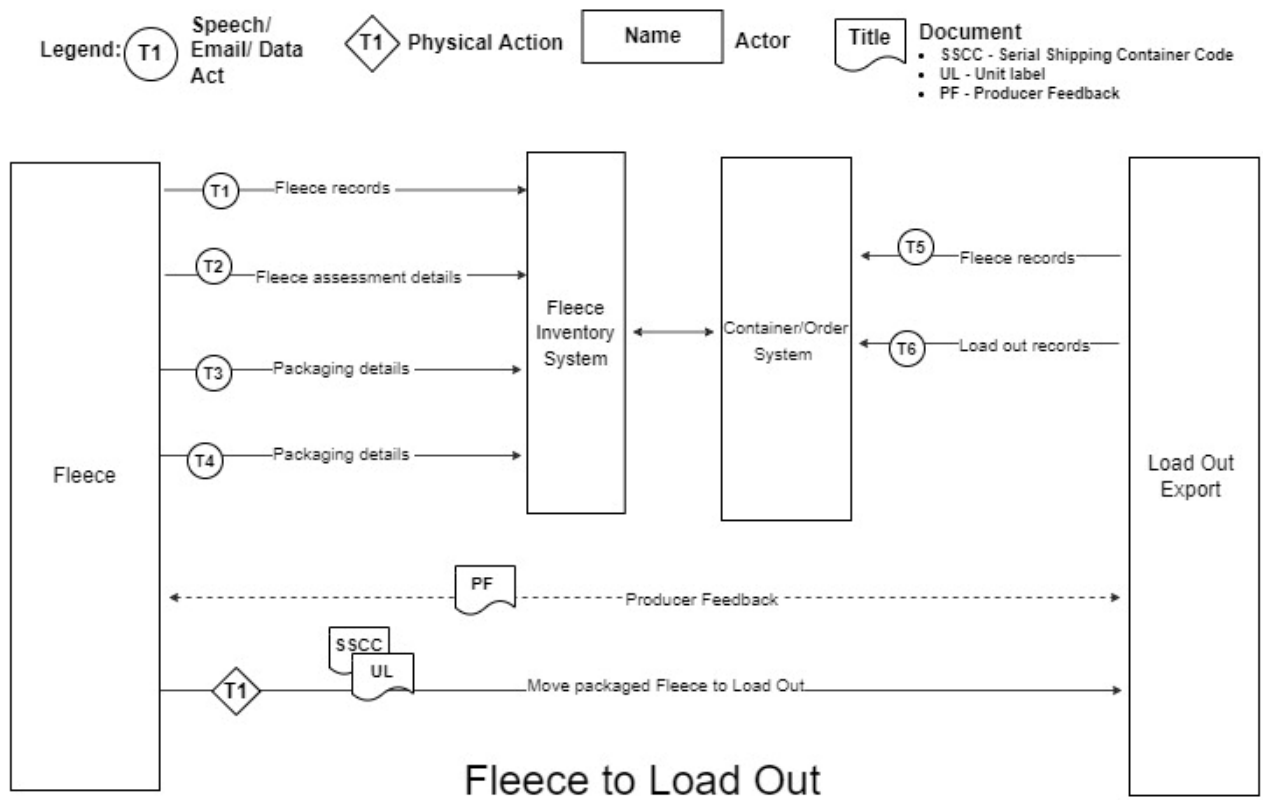

Figure 56. Data or information flows from the slaughter floor to fleece/render loadout systems in the small stock supply chain

5.2.2.8 Cold store (carcase)

Storing chilled carcasses or carcase products (e.g., cartons) typically provides a stock buffer between production and dispatch of product intended for domestic or export markets. A cold storage system involves refrigerated chambers that can chill or freeze any perishable product for a period of time before dispatch. During this process, the ageing of meat also occurs, progressively increasing tenderness and flavour. Storage rooms must take into account the storage requirements for different products, as well as rules for loading maintenance and hygiene of storage equipment. Carcasses, identified by unique GS1 barcoded carcase tickets, are stored, unloaded, and loaded on rails and may lose weight via evaporation. Therefore, short storage times for carcasses is very important.

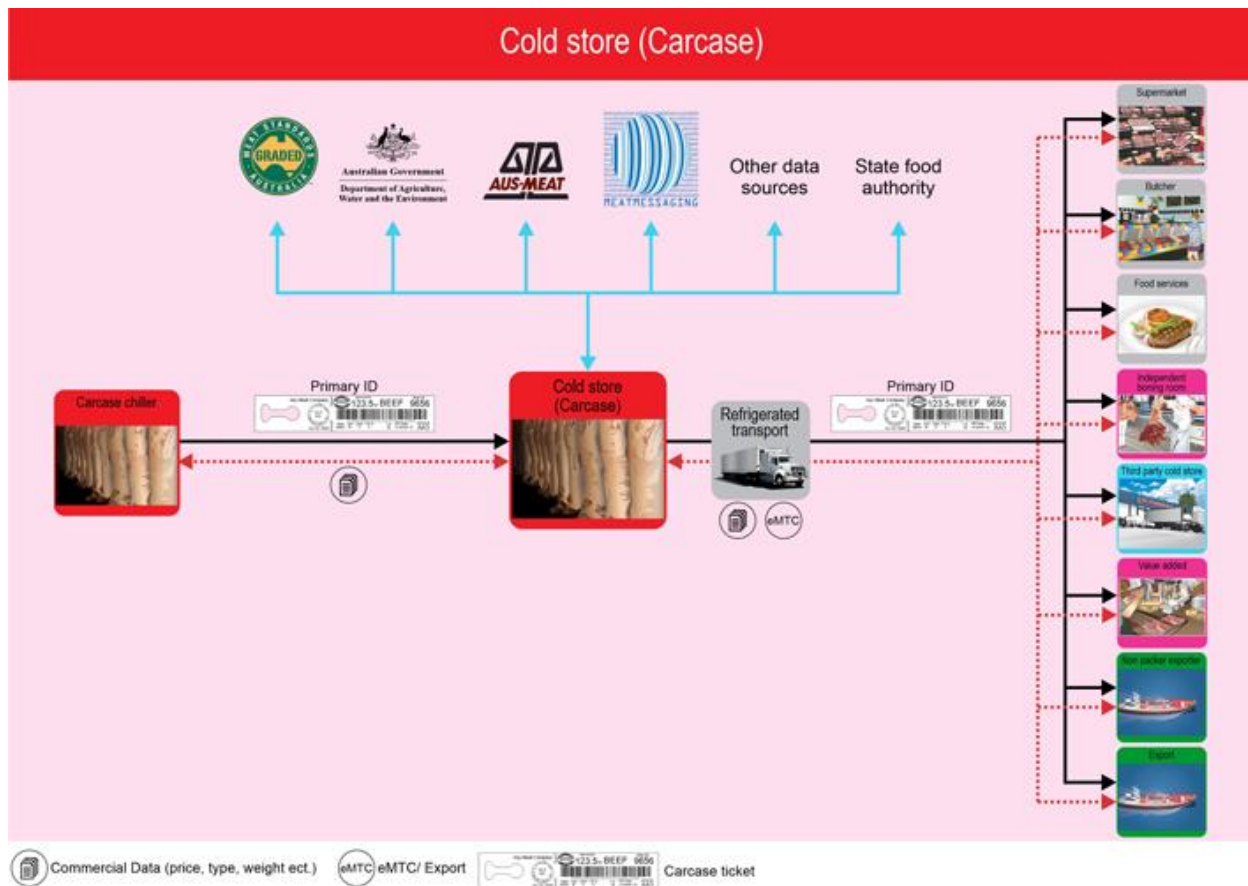

Figure 57. Inputs and outputs of the small stock supply chain cold store (carcase) sector.

5.2.2.8.1 Physical Inputs including Critical Tracking Events (CTEs)

The physical inputs into the cold storage unit include dressed carcasses which have been passed as safe for human consumption by an Authorised Officer. Critical Tracking Event related documents accompanying these carcasses may include the Carcase Ticket and MSA carcase ticket. This information is recorded in the processing plants production management system.

Critical Tracking Events (CTEs) are defined as those events which include the growing, receiving, transforming, creating, and shipping of food products. Such events are critical to the traceability of product throughout the supply chain.

The CTEs associated with inputs to the cold store (carcase) system include the receipt of:

- Carcase.

Table 50. Physical inputs and associated Critical Tracking Event related documents for a small stock cold store (carcase) system.

Event related to the inputs	Description of the inputs	Critical Tracking Event (CTE) related documents (including electronic)	More details
Carcase	The body of a slaughtered animal after bleeding. Becomes a dressed carcass when hide/skin, head, feet, and offal are removed.	Carcass Ticket, MSA Carcass Ticket, Processing plant production management system	

5.2.2.8.2 Information Inputs including Key Data Elements (KDEs)

Key Data Elements (KDEs) are defined as those elements which are key in identifying and tracing the Critical Tracking Event (CTE). There are a number of information inputs associated with the movement of carcasses into the cold storage system. These are largely included on the Carcass Ticket and are Key Data Elements encapsulated by the GS1 barcode, as well as other information required by federal legislation.

Table 51. Information inputs, Key Data Elements and Critical Tracking Event related documentation for a small stock cold store (carcase) system.

Attributes (including KDEs)	Description of the Attributes (including KDEs)	Is a KDE	Critical Tracking Event (CTE) related documents (including electronic)	More details
Body number	This is a number assigned to each carcass by the processor for identification purposes.	Yes	Carcass Ticket, Processing plant production management system	
From Establishment number	A number issued by Federal and State Authorities to identify the originating site from which meat or meat products were distributed to domestic or export markets. For transfer certificates, the Establishment numbers for both the dispatching and receiving establishments are recorded.	Yes	Carcass Ticket, Processing plant production management system	
Global Trade Item Number (GTIN)	Encoded in the GS1 barcode, the GTIN is a globally unique 14-digit number used to identify trade items, products, or services.	Yes	Carcass Ticket, Processing plant production management system	For more information visit the GS1 website.
Lot number	A lot is a number assigned by the processor to each group of livestock consigned to slaughter and is usually vendor specific.	Yes	Carcass Ticket, Processing plant production management system	
MSA eating quality group/grade	This identifies carcasses with similar MSA and eating quality grades, these may align with brands packed by the processor for logistic simplicity. Carcasses are grouped for boning according to eating quality grades.	Yes	MSA Carcass Ticket, Processing plant	For more information on MSA visit the MLA website.

			production management system	
Net Weight (Kilograms)	Usually encoded in the GS1 barcode, the Net Weight is a variable measure of the trade item e.g., carton, pallet or shipment recorded in kilograms.	Yes	Carcase Ticket, Processing plant production management system	For more information visit the GS1 website.
Official mark	Any stamp, seal, label, or mark that is declared by the regulations to be an official mark. An official mark signifies that the product has been inspected by and approved as safe for human consumption by an Authorised Officer.	Yes	Carcase Ticket	
Production Date (YYMMDD)	Encoded in the GS1 barcode, this is the 'kill' or slaughter' date of the product and is recorded in the format year, month, day (YYMMDD).	Yes	Carcase Ticket, Processing plant production management system	For more information visit the GS1 website.
Serial Number	Encoded in the GS1 barcode, this is a code, numeric or alphanumeric, assigned to an individual instance of an item for its lifetime.	Yes	Carcase Ticket, Processing plant production management system	For more information visit the GS1 website.
Trade description	This is a collective set of words that says what the product is and may include information such as species, net weight of product, name and address of establishments, category ciphers, market endorsements, MSA eating quality etc.	Yes	Carcase Ticket, Processing plant production management system	

5.2.2.8.3 Physical Outputs including Critical Tracking Events (CTEs)

The physical outputs of the carcass chiller system include carcasses passed as safe for human consumption; these may be loaded into container system units for transport. Documents accompanying the movement of carcasses out of the cold storage system include those such as the delivery docket/manifest, Meat Transfer Certificate (MTC).

Critical Tracking Events (CTEs) are defined as those events which include the growing, receiving, transforming, creating, and shipping of food products. Such events are critical to the traceability of product throughout the supply chain.

The CTEs associated with the outputs of the cold store (carcass) system include the movement of:

- Carcass
- Container System Unit

off the property, premises, or supply chain sector.

Table 52. Physical outputs and associated Critical Tracking Event related documents for a small stock cold store (carcase) system.

Event related to the inputs	Description of the inputs	Critical Tracking Event (CTE) related documents (including electronic)	More details
Carcase	The body of a slaughtered animal after bleeding. Becomes a dressed carcase when hide/skin, head, feet, and offal are removed.	Carcase Ticket, Delivery Docket/Manifest, Meat Transfer Certificate (MTC), MSA Carcase Ticket, Processing plant production management system, Receipt of purchase/Tax Invoice	
Container System Unit	A container designed for use as a unit of cargo handling equipment in the transport of goods by aircraft or ship.	Bill of lading/Air Waybill, Certificate of Analysis (COA), Delivery Docket/Manifest, Export Health Certificate, Export Permit, Meat Messaging Consignment Report, Meat Transfer Certificate (MTC), Official seal, Processing plant production management system, Receipt of purchase/Tax Invoice	

5.2.2.8.4 Information Outputs including Key Data Elements (KDEs)

Key Data Elements (KDEs) are defined as those elements which are key in identifying and tracing the Critical Tracking Event (CTE). The information outputs relating to the movement of carcasses out of the cold storage system are derived from CTE documentation ranging from Receipt of purchase/Tax Invoices to the Bill of lading/Air Waybill and Meat Messaging Consignment Reports. This information will be stored in the processing plants production management system.

Table 53. Information outputs, Key Data Elements and Critical Tracking Event related documentation for a small stock cold store (carcase) system.

Attributes (including KDEs)	Description of the Attributes (including KDEs)	Is a KDE	Critical Tracking Event (CTE) related documents (including electronic)	More details
Analysis Date	This is the date on which a product sample was analysed.	Yes	Certificate of Analysis (COA), Processing plant production management system	
Bill of lading/Air Waybill document number	A unique document number issued for traceability purposes.	Yes	Bill of lading/Air Waybill, Certificate of Analysis (COA), Processing plant production management system	
Body number	This is a number assigned to each carcase by the processor for identification purposes.	Yes	Carcase Ticket, Processing plant production management system	
Certificate of Analysis number	A unique certificate number issued for traceability purposes.	Yes	Certificate of Analysis (COA), Processing plant production management system	
Company/product code	This is an in-house code for the identification of the product in the unit.	Yes	Bill of lading/Air Waybill, Certificate of Analysis (COA), Processing plant production management system, Receipt of purchase/Tax Invoice	
Consignment Serial Shipping	Encoded in the GS1 barcode, this is a unique number which identifies the individual logistic unit i.e.,	Yes	Bill of lading/Air Waybill, Meat Messaging Consignment Report, Meat	For more information visit the GS1 website.

Container Code (SSCC)	shipment/message that is assigned by the establishment constructing the unit. The SSCC remains the same for the life of the logistic unit.		Transfer Certificate (MTC), Processing plant production management system	
Contract number	This is a unique number allocated to the contract by the seller.	Yes	Delivery Docket/Manifest, Processing plant production management system	
Count of Pallets	This is the number of pallets in the logistic unit e.g., container system unit.	Yes	Meat Messaging Consignment Report, Processing plant production management system	
Count of Trade Items	Usually encoded in the GS1 barcode, this is the number of trade items e.g., cartons in the logistic unit.	Yes	Bill of lading/Air Waybill, Delivery Docket/Manifest, Meat Messaging Consignment Report, Processing plant production management system	For more information visit the GS1 website.
Date	This is the date of signing or of which a record entry or transaction was made.	Yes	Bill of lading/Air Waybill, Certificate of Analysis (COA), Delivery Docket/Manifest, Meat Messaging Consignment Report, Meat Transfer Certificate (MTC), Processing plant production management system, Receipt of purchase/Tax Invoice	
Delivery Docket/Manifest number	This is a unique number allocated to the docket for identification purposes.	Yes	Delivery Docket/Manifest, Processing plant production management system	
Export Health Certificate Number	A unique number allocated to the health certificate issued for the export consignment for traceability purposes.	Yes	Export Health Certificate, Meat Messaging Consignment Report, Processing plant production management system	For more information visit the Department of Agriculture, Water and the Environment website.
Export Permit Number	A unique permit number is allocated for the export consignment following submission of a correct and validated Request For Permit (RFP) which is then approved by the Secretary.	Yes	Export Permit, Processing plant production management system	For more information visit the Department of Agriculture, Water and the Environment website.
From Establishment number	A number issued by Federal and State Authorities to identify the originating site from which meat or meat products were distributed to domestic or export markets. For transfer certificates, the Establishment numbers for both the dispatching and receiving establishments are recorded.	Yes	Carcase Ticket Certificate of Analysis (COA), Delivery Docket/Manifest, Export Health Certificate, Meat Messaging Consignment Report, Meat Transfer Certificate (MTC), Processing plant production management system	
Global Trade Item Number (GTIN)	Encoded in the GS1 barcode, the GTIN is a globally unique 14-digit	Yes	Carcase Ticket, Meat Messaging Consignment	For more information

	number used to identify trade items, products, or services.		Report, Processing plant production management system	visit the GS1 website.
Movement date	The date on which livestock or other products (e.g., feed or meat products) were transported between PICs/establishments.	Yes	Bill of lading/Air Waybill, Certificate of Analysis (COA), Delivery Docket/Manifest, Export Health Certificate, Meat Transfer Certificate (MTC), Processing plant production management system	
MSA eating quality group/grade	This identifies carcasses with similar MSA and eating quality grades, these may align with brands packed by the processor for logistic simplicity. Carcasses are grouped for boning according to eating quality grades.	Yes	MSA Carcase Ticket, Processing plant production management system	For more information on MSA visit the MLA website.
MSA Licence Number	Any establishment consigning, supplying, or identifying MSA Certified Product must be registered and have a unique MSA Licence Number.	Yes	Processing plant production management system, Receipt of purchase/Tax Invoice	For more information on MSA visit the MLA website.
Net Weight (Kilograms)	Usually encoded in the GS1 barcode, the Net Weight is a variable measure of the trade item e.g., carton, pallet or shipment recorded in kilograms.	Yes	Bill of lading/Air Waybill, Carcase Ticket, Export Health Certificate, Meat Messaging Consignment Report, Processing plant production management system	For more information visit the GS1 website.
Official mark	Any stamp, seal, label, or mark that is declared by the regulations to be an official mark. An official mark signifies that the product has been inspected by and approved as safe for human consumption by an Authorised Officer.	Yes	Carcase Ticket	
Order date	This is the date on which the purchase order or contract was raised by the buyer.	Yes	Delivery Docket/Manifest, Processing plant production management system	
Pallet Serial Shipping Container Code (SSCC)	Encoded in the GS1 barcode, this is a unique number which identifies the individual logistic unit i.e., pallet that is assigned by the establishment constructing the unit. The SSCC remains the same for the life of the logistic unit.	Yes	Meat Messaging Consignment Report, Meat Transfer Certificate (MTC), Processing plant production management system	For more information visit the GS1 website.
Production Date (YYMMDD)	Encoded in the GS1 barcode, this is the 'kill' or slaughter' date of the product and is recorded in the format year, month, day (YYMMDD).	Yes	Carcase Ticket, Certificate of Analysis (COA), Meat Transfer Certificate (MTC), Processing plant production management system	For more information visit the GS1 website.
Recipient Australian	This is an 11-digit registration number, issued by the Australian Tax Office, used to identify businesses.	Yes	Processing plant production management system, Receipt of purchase/Tax Invoice	For more information visit the ATO website.

Business Number (ABN)				
Seal Serial Number	This is a unique serial number printed on any tamper-evident seal issued by the Department.	Yes	Bill of lading/Air Waybill, Meat Transfer Certificate (MTC), Official seal, Processing plant production management system	For more information visit the Australian Government Federal Register of Legislation.
Seller/Supplier Australian Business Number (ABN)	This is an 11-digit registration number, issued by the Australian Tax Office, used to identify businesses.	Yes	Processing plant production management system, Receipt of purchase/Tax Invoice	For more information visit the ATO website.
Serial Number	Encoded in the GS1 barcode, this is a code, numeric or alphanumeric, assigned to an individual instance of an item for its lifetime.	Yes	Carcase Ticket, Processing plant production management system	For more information visit the GS1 website.
Shipping Mark	Also known as a port mark, this is a code comprising of three letters representing the foreign establishment number and the last nine digits of the consignment SSCC.	Yes	Bill of lading/Air Waybill, Certificate of Analysis (COA), Delivery Docket/Manifest, Export Health Certificate, Meat Messaging Consignment Report, Processing plant production management system	
To Establishment number	A number issued by Federal and State Authorities to identify the originating site from which meat or meat products were distributed to domestic or export markets. For transfer certificates, the Establishment numbers for both the dispatching and receiving establishments are recorded.	Yes	Meat Transfer Certificate (MTC), Processing plant production management system	
Trade description	This is a collective set of words that says what the product is and may include information such as species, net weight of product, name and address of establishments, category ciphers, market endorsements, MSA eating quality etc.	Yes	Carcase Ticket, Delivery Docket/Manifest, Export Health Certificate, Meat Messaging Consignment Report, Meat Transfer Certificate (MTC), Processing plant production management system	
Transfer Certificate number	A unique certificate number issued for traceability purposes.	Yes	Meat Messaging Consignment Report, Meat Transfer Certificate (MTC), Processing plant production management system	
Transport registration number	The registration number of the vehicle in which the animals or product were transported. For shipments of product this will be a shipping container number.	Yes	Bill of lading/Air Waybill, Delivery Docket/Manifest, Export Health Certificate, Meat Messaging Consignment Report, Meat Transfer Certificate (MTC),	

			Processing plant production management system	
--	--	--	---	--

5.2.2.8.5 Regulatory and Industry Programs

- Meat Standards Australia (MSA)
- AUS-MEAT
- Australian Meat Industry Council (AMIC)
- Department of Agriculture
- Meat Messaging
- State food authority
- Other data sources

5.2.2.8.6 Supply Chain Node Traceability

Traceability of whole carcasses back to the live animal or consignment group is possible, depending on the NLIS tag type, and can be done by the processing establishment where the animal was slaughtered. Here, carcasses are issued a carcass ticket which correlates to the PIC number or live animal identifier and contains key information, including GS1 meat industry barcode, body number, processing establishment number and production date or 'kill date'. This information is uploaded to the NLIS Database, by the processor, under the processing establishments Property Identification Code (PIC). Thus, whole carcasses (identified with a unique serialised carcass ticket) within a processing facility, chiller, cold store, or that are loaded for export or transport to other premises (e.g., retail) are fully traceable back to the individual live animal, or the consignment group and property of origin.

5.2.2.8.7 Data flow diagrams

Table 54. Data flow diagrams for the inputs and outputs of a small stock cold store (carcass) system.

Direction	Description
Input	Slaughter to Chiller
Output	Cold Store (Carcass) to Supermarket
Output	Cold Store (Carcass) to Butcher
Output	Cold Store (Carcass) to Food Services
Output	Cold Store (Carcass) to Third Party Cold Store
Output	Cold Store to Value added

5.2.2.8.7.1 Slaughter to Cold store (Carcase)

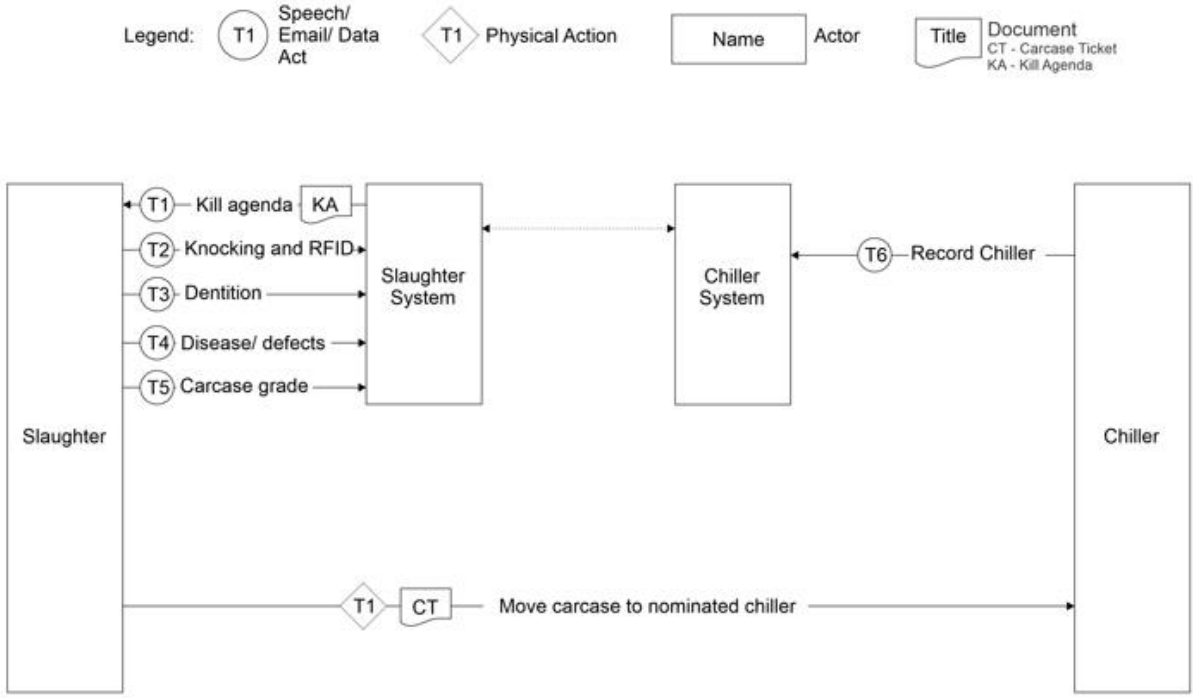

Slaughter to Chiller

Figure 58. Data or information flows from the slaughter to chiller systems in the small stock supply chain.

5.2.2.8.7.2 Cold store (Carcase) to Supermarket

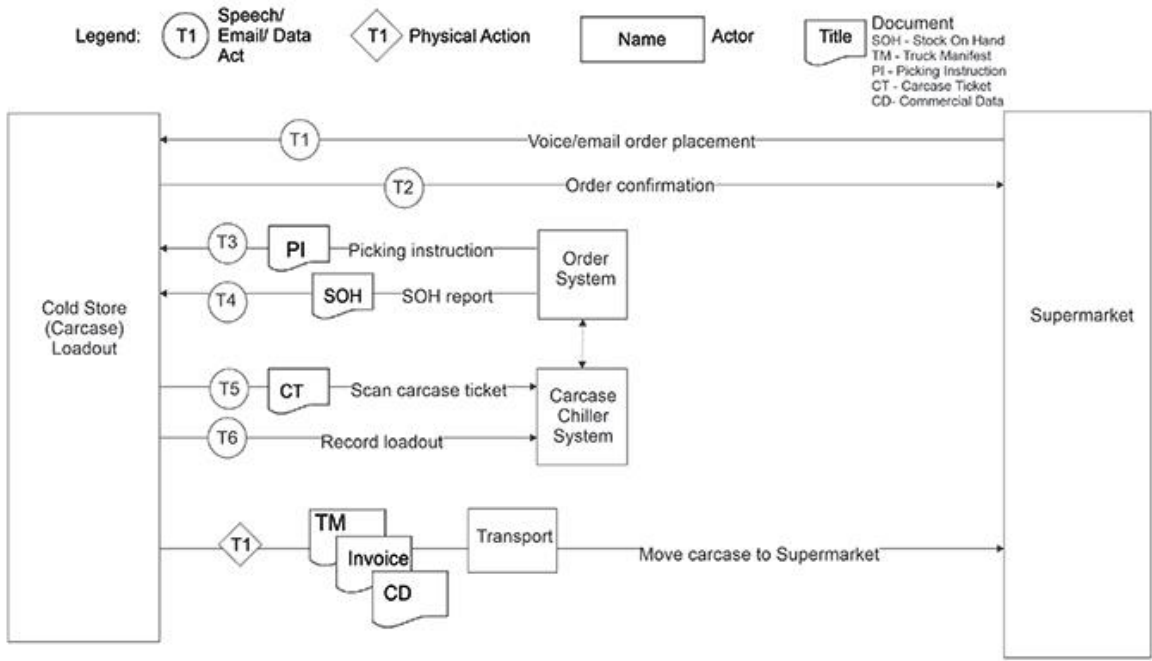

Cold Store (Carcase) to Supermarket

Figure 59. Data or information flows from the cold store (carcase) to supermarket systems in the small stock supply chain.

5.2.2.8.7.3 Cold store (Carcase) to Butcher

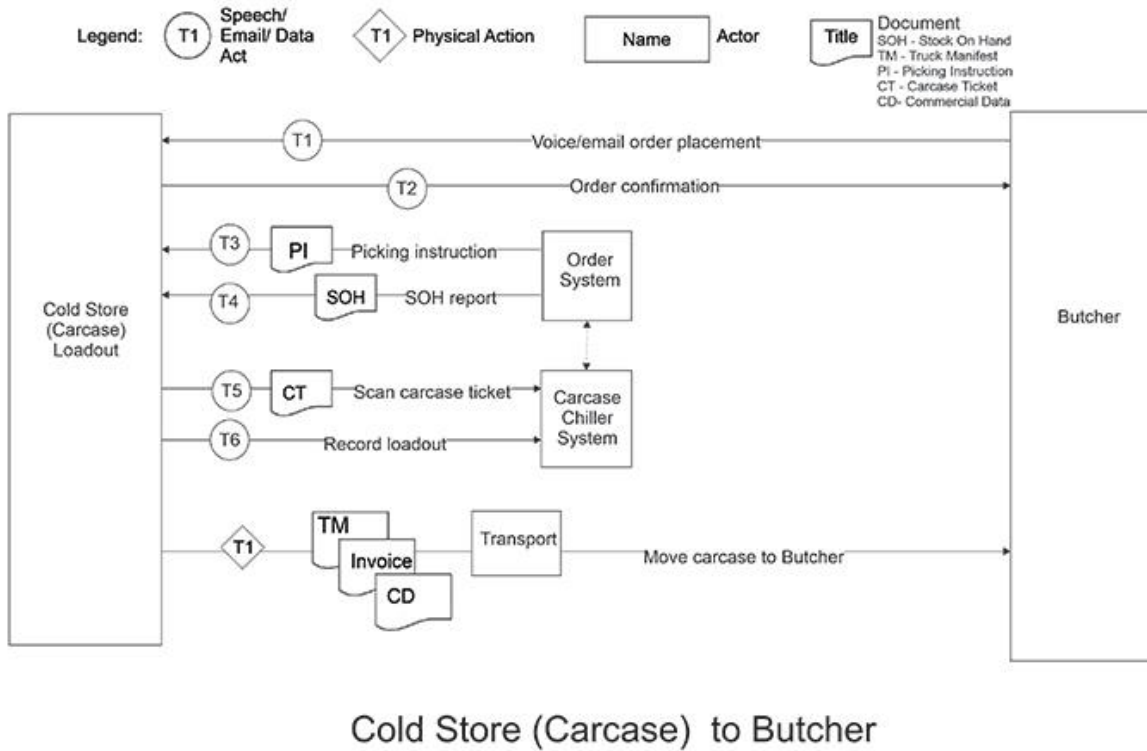

Cold Store (Carcase) to Butcher

Figure 60. Data or information flows from the cold store (carcase) to butcher systems in the small stock supply chain.

5.2.2.8.7.4 Cold store (Carcase) to Food Service

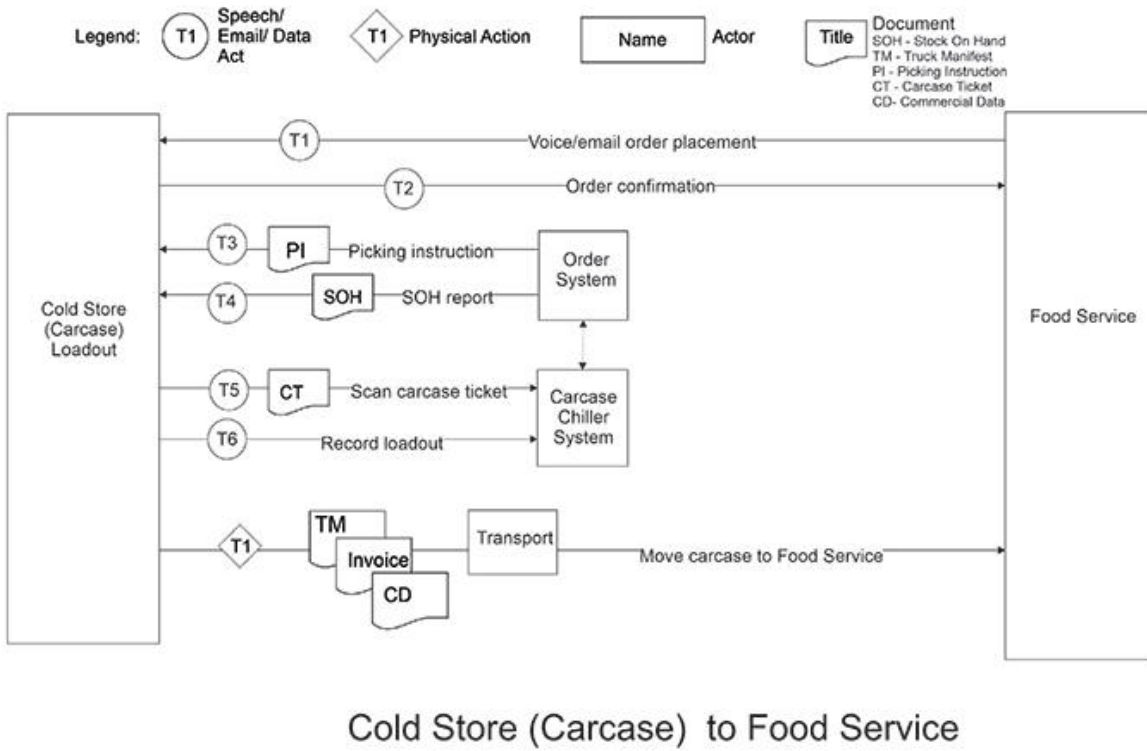

Figure 61. Data or information flows from the cold store (carcase) to food service systems in the small stock supply chain.

5.2.2.8.7.5 Cold store (Carcase) to Third-Party Cold Store

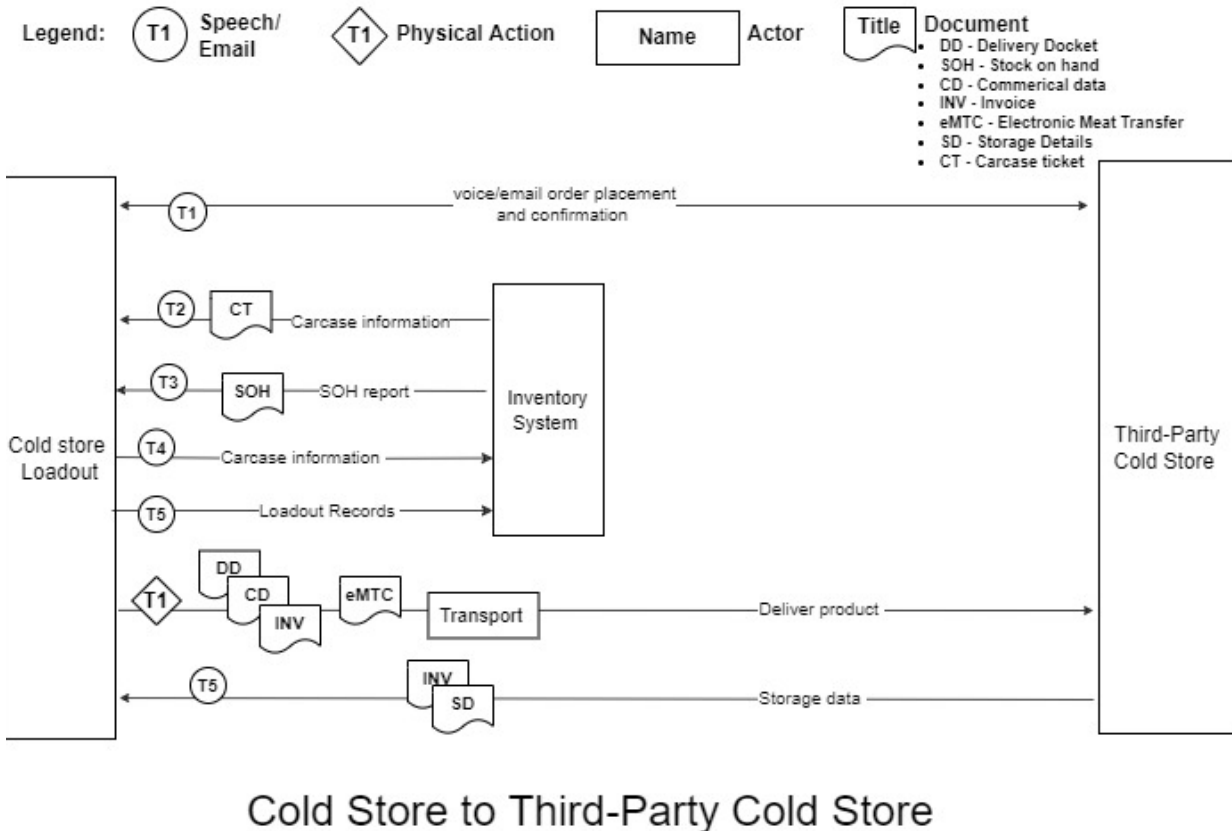

Figure 62. Data or information flows from the cold store (carcase) to third-party cold store systems in the small stock supply chain.

5.2.2.8.7.6 Cold store (Carcase) to Value Adding

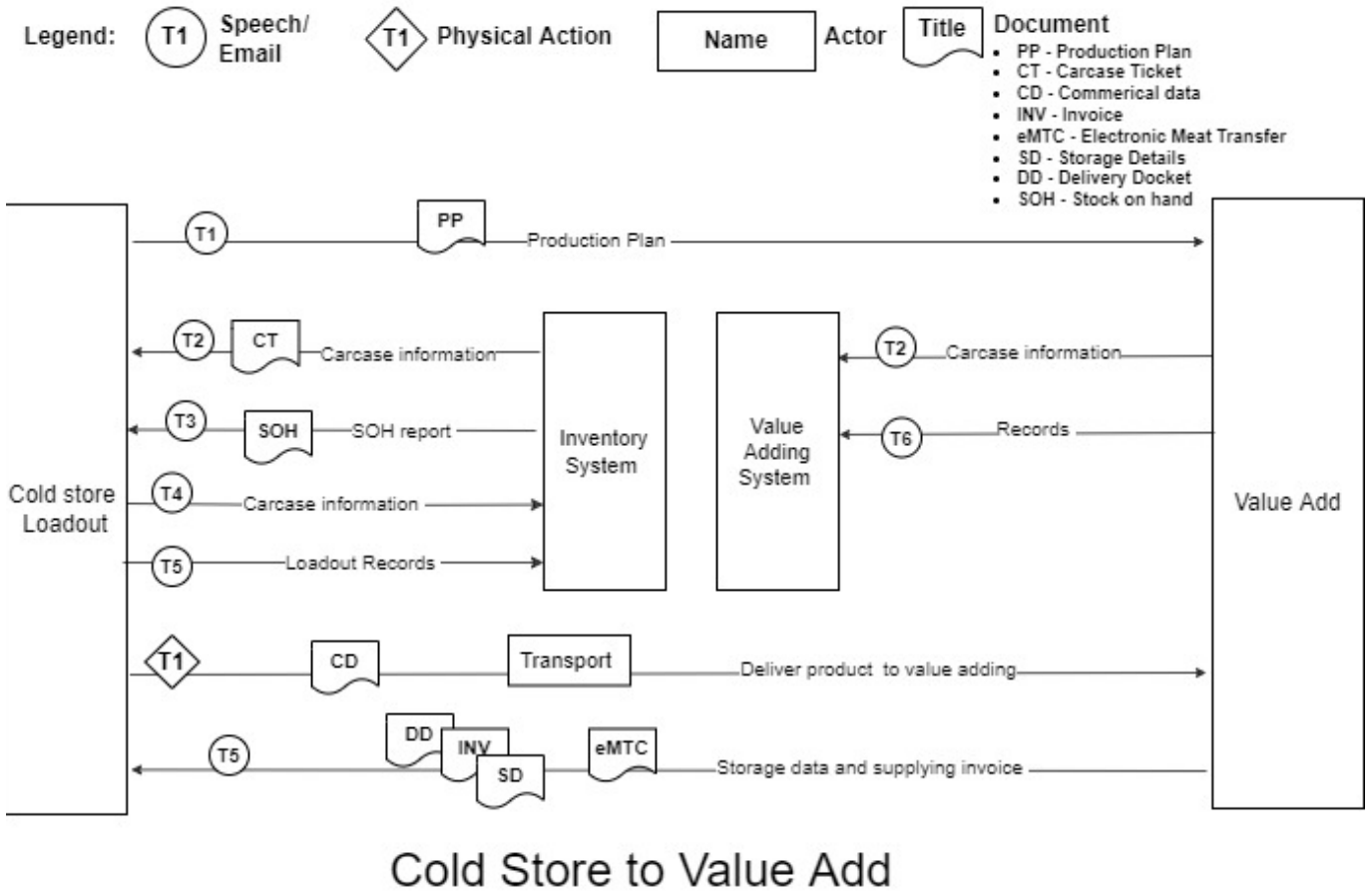

Figure 63. Data or information flows from the cold store (carcase) to value adding systems in the small stock supply chain.

5.2.2.9 Cold store (cartons)

Storing chilled carcasses or carcase products (e.g., cartons) typically provides a stock buffer between production and dispatch of product intended for domestic or export markets. A cold storage system involves refrigerated chambers that can chill or freeze any perishable product for a period of time before dispatch. During this process, ageing of meat also occurs, progressively increasing tenderness and flavour. Storage rooms must take into account the storage requirements for different products as well as rules for loading, maintenance and hygiene of storage equipment. Cartons, identified by unique GS1 barcoded carton labels, are palletised with each pallet being identified by a unique GS1 barcoded pallet label. These pallets are loaded onto pallet racking for storage in the chiller system.

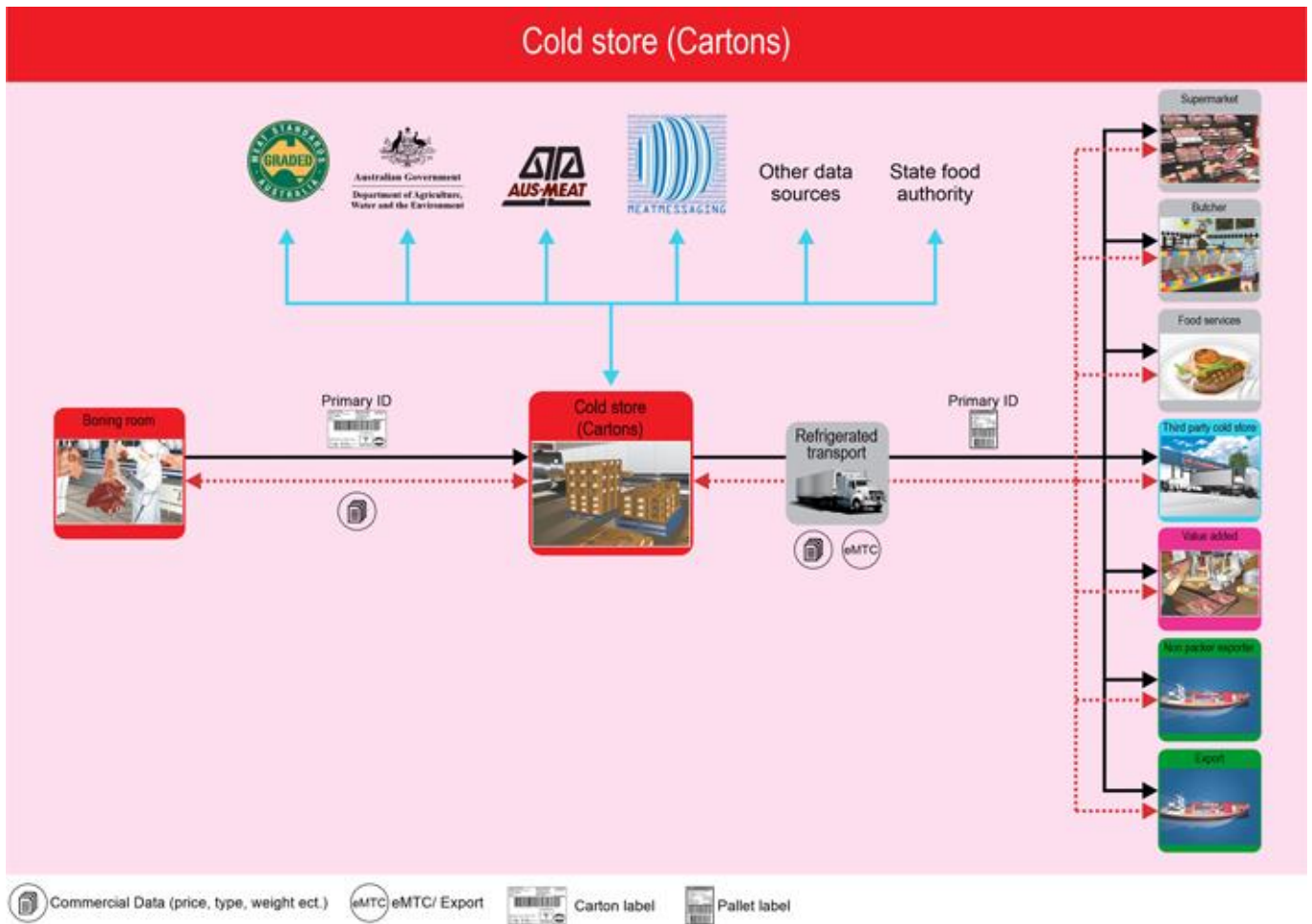

Figure 64. Inputs and outputs of the small stock supply chain cold store (cartons) sector.

5.2.2.9.1 Physical Inputs including Critical Tracking Events (CTEs)

The physical inputs into the carton cold storage unit include cartons and pallets comprising of boned product that has been passed as safe for human consumption by an Authorised Officer. Critical Tracking Event related documents accompanying these inputs may include the carton and pallet labels. This information is recorded in the processing plants production management system.

Critical Tracking Events (CTEs) are defined as those events which include the growing, receiving, transforming, creating, and shipping of food products. Such events are critical to the traceability of product throughout the supply chain.

The CTEs associated with inputs to the cold store (cartons) system include the receipt of:

- Carton
- Pallet.

Table 55. Physical inputs and associated Critical Tracking Event related documents for a small stock cold store (carton) system.

Event related to the inputs	Description of the inputs	Critical Tracking Event (CTE) related documents (including electronic)	More details
-----------------------------	---------------------------	--	--------------

Carton	This is a case, crate, or barrel of product.	Carton label, Official seal, Processing plant production management system	
Pallet	A logistic unit which includes a number of cartons or goods items packed together for transport or storage purposes.	Processing plant production management system, SSCC/Pallet label	

5.2.2.9.2 Information Inputs including Key Data Elements (KDEs)

Key Data Elements (KDEs) are defined as those elements which are key in identifying and tracing the Critical Tracking Event (CTE). There are a number of information inputs associated with the movement of product into the carton cold storage system. These are largely included on the carton and pallet labels and are Key Data Elements encapsulated by the GS1 barcode, as well as other information required by federal legislation.

Table 56. Information inputs, Key Data Elements and Critical Tracking Event related documentation for a small stock cold store (carton) system.

Attributes (including KDEs)	Description of the Attributes (including KDEs)	Is a KDE	Critical Tracking Event (CTE) related documents (including electronic)	More details
Company/product code	This is an in-house code for the identification of the product in the unit.	Yes	Carton label, Processing plant production management system, SSCC/Pallet label	
Consignment Serial Shipping Container Code (SSCC)	Encoded in the GS1 barcode, this is a unique number which identifies the individual logistic unit i.e., shipment/message that is assigned by the establishment constructing the unit. The SSCC remains the same for the life of the logistic unit.	Yes	Processing plant production management system, SSCC/Pallet label	For more information visit the GS1 website.
Count of Trade Items	Usually encoded in the GS1 barcode, this is the number of trade items e.g., cartons in the logistic unit.	Yes	Processing plant production management system, SSCC/Pallet label	For more information visit the GS1 website.
From Establishment number	A number issued by Federal and State Authorities to identify the originating site from which meat or meat products were distributed to domestic or export markets. For transfer certificates, the Establishment numbers for both the dispatching and receiving establishments are recorded.	Yes	Carton label, Processing plant production management system, SSCC/Pallet label	

Global Trade Item Number (GTIN)	Encoded in the GS1 barcode, the GTIN is a globally unique 14-digit number used to identify trade items, products, or services.	Yes	Carton label, Processing plant production management system, SSCC/Pallet label	For more information visit the GS1 website.
GTIN of Contained Trade Items	Encoded in the GS1 barcode, the GTIN of the contained trade items is a globally unique 14-digit number used to identify trade items, products, or services in the logistic unit.	Yes	Processing plant production management system, SSCC/Pallet label	For more information visit the GS1 website.
Lot number	A lot is a number assigned by the processor to each group of livestock consigned to slaughter and is usually vendor specific.	Yes	Carcase Ticket, Processing plant production management system	
Net Weight (Kilograms)	Usually encoded in the GS1 barcode, the Net Weight is a variable measure of the trade item e.g., carton, pallet or shipment recorded in kilograms.	Yes	Carton label, Processing plant production management system, SSCC/Pallet label	For more information visit the GS1 website.
Official mark	Any stamp, seal, label, or mark that is declared by the regulations to be an official mark. An official mark signifies that the product has been inspected by and approved as safe for human consumption by an Authorised Officer.	Yes	Carton label, SSCC/Pallet label	
Packaging Date	Encoded in the GS1 barcode, the Packaging Date is the date on which the item was packaged and is recorded in the format year, month, day (YYMMDD).	Yes	Carton label, Processing plant production management system, SSCC/Pallet label	For more information visit the GS1 website.
Packaging Date Range	This includes the oldest and newest packaging dates for the logistic unit.	Yes	Processing plant production management system, SSCC/Pallet label	For more information visit the GS1 website.
Pallet Serial Shipping Container Code (SSCC)	Encoded in the GS1 barcode, this is a unique number which identifies the individual logistic unit i.e., pallet that is assigned by the establishment constructing	Yes	Processing plant production management	For more information visit the GS1 website.

	the unit. The SSCC remains the same for the life of the logistic unit.		system, SSCC/Pallet label	
Seal Serial Number	This is a unique serial number printed on any tamper-evident seal issued by the Department.	Yes	Official seal, Processing plant production management system	For more information visit the GS1 website.
Serial Number	Encoded in the GS1 barcode, this is a code, numeric or alphanumeric, assigned to an individual instance of an item for its lifetime.	Yes	Carton label, Processing plant production management system	For more information visit the GS1 website.
Shipping Mark	Also known as a port mark, this is a code comprising of three letters representing the foreign establishment number and the last nine digits of the consignment SSCC.	Yes	Processing plant production management system, SSCC/Pallet label	
Trade description	This is a collective set of words that says what the product is and may include information such as species, net weight of product, name and address of establishments, category ciphers, market endorsements, MSA eating quality etc.	Yes	Carton label, Processing plant production management system, SSCC/Pallet label	

5.2.2.9.3 Physical Outputs including Critical Tracking Events (CTEs)

The physical outputs of the carton cold storage system include cartons and pallets, these may be loaded into container system units for transport. Documents accompanying the movement of outputs of the cold storage system include those such as the delivery docket/manifest, Meat Transfer Certificate (MTC) and Meat Messaging Consignment Report

Critical Tracking Events (CTEs) are defined as those events which include the growing, receiving, transforming, creating, and shipping of food products. Such events are critical to the traceability of product throughout the supply chain.

The CTEs associated with the outputs of the cold store (cartons) system include the movement of:

- Carton
- Container System Unit
- Pallet

off the property, premises, or supply chain sector.

Table 57. Physical outputs and associated Critical Tracking Event related documents for a small stock cold store (carton) system.

Event related to the inputs	Description of the inputs	Critical Tracking Event (CTE) related documents (including electronic)	More details
Carton	This is a case, crate, or barrel of product.	Carton label, Delivery Docket/Manifest, Meat Transfer Certificate (MTC), Official seal, Processing plant production management system, Receipt of purchase/Tax Invoice	
Container System Unit	A container designed for use as a unit of cargo handling equipment in the transport of goods by aircraft or ship.	Bill of lading/Air Waybill, Certificate of Analysis (COA), Delivery Docket/Manifest, Export Health Certificate, Export Permit, Meat Messaging Consignment Report, Meat Transfer Certificate (MTC), Official seal, Processing plant production management system, Receipt of purchase/Tax Invoice	
Pallet	A logistic unit which includes a number of cartons or goods items packed together for transport or storage purposes.	Bill of lading/Air Waybill, Certificate of Analysis (COA), Delivery Docket/Manifest, Export Health Certificate, Export Permit, Meat Transfer Certificate (MTC), Processing plant production management system, Receipt of purchase/Tax Invoice, SSSC/Pallet label	

5.2.2.9.4 Information Outputs including Key Data Elements (KDEs)

Key Data Elements (KDEs) are defined as those elements which are key in identifying and tracing the Critical Tracking Event (CTE). The information outputs relating to the movement of outputs of the cold storage system is derived from CTE documentation ranging from Receipt of purchase/Tax Invoices to the Bill of lading/Air Waybill and Meat Messaging Consignment Reports. This information will be stored in the processing plants production management system.

Table 58. Information outputs, Key Data Elements and Critical Tracking Event related documentation for a small stock cold store (carton) system.

Attributes (including KDEs)	Description of the Attributes (including KDEs)	Is a KDE	Critical Tracking Event (CTE) related documents (including electronic)	More details
Analysis Date	This is the date on which a product sample was analysed.	Yes	Certificate of Analysis (COA), Processing plant production management system	
Bill of lading/Air Waybill document number	A unique document number issued for traceability purposes.	Yes	Bill of lading/Air Waybill, Certificate of Analysis (COA), Processing plant production management system	
Certificate of Analysis number	A unique certificate number issued for traceability purposes.	Yes	Certificate of Analysis (COA), Processing plant production management system	
Company/product code	This is an in-house code for the identification of the product in the unit.	Yes	Bill of lading/Air Waybill, Carton label, Processing plant production management system, Receipt of purchase/Tax Invoice, SSSC/Pallet label	
Consignment Serial Shipping	Encoded in the GS1 barcode, this is a unique number which identifies	Yes	Bill of lading/Air Waybill, Export clearance documentation,	For more information

Container Code (SSCC)	the individual logistic unit i.e., shipment/message that is assigned by the establishment constructing the unit. The SSCC remains the same for the life of the logistic unit.		Meat Messaging Consignment Report, Meat Transfer Certificate (MTC), Processing plant production management system, SSCC/Pallet label	visit the GS1 website.
Contract number	This is a unique number allocated to the contract by the seller.	Yes	Delivery Docket/Manifest, Processing plant production management system	
Count of Pallets	This is the number of pallets in the logistic unit e.g., container system unit.	Yes	Meat Messaging Consignment Report, Processing plant production management system	
Count of Trade Items	Usually encoded in the GS1 barcode, this is the number of trade items e.g., cartons in the logistic unit.	Yes	Bill of lading/Air Waybill, Delivery Docket/Manifest, Meat Messaging Consignment Report, Processing plant production management system, SSCC/Pallet label	For more information visit the GS1 website.
Date	This is the date of signing or of which a record entry or transaction was made.	Yes	Bill of lading/Air Waybill, Certificate of Analysis (COA), Delivery Docket/Manifest, Export clearance documentation, Meat Messaging Consignment Report, Meat Transfer Certificate (MTC), Processing plant production management system, Receipt of purchase/Tax Invoice	
Delivery Docket/Manifest number	This is a unique number allocated to the docket for identification purposes.	Yes	Delivery Docket/Manifest, Processing plant production management system	
Export Health Certificate Number	A unique number allocated to the health certificate issued for the export consignment for traceability purposes.	Yes	Export Health Certificate, Meat Messaging Consignment Report, Processing plant production management system	For more information visit the Department of Agriculture, Water and the Environment website.
Export Permit Number	A unique permit number is allocated for the export consignment following submission of a correct and validated Request For Permit (RFP) which is then approved by the Secretary.	Yes	Export Permit, Processing plant production management system	For more information visit the Department of Agriculture, Water and the Environment website.
From Establishment number	A number issued by Federal and State Authorities to identify the originating site from which meat or meat products were distributed to domestic or export markets. For transfer certificates, the	Yes	Carton label, Certificate of Analysis (COA), Delivery Docket/Manifest, Export clearance documentation, Export Health Certificate, Meat Messaging Consignment	

	Establishment numbers for both the dispatching and receiving establishments are recorded.		Report, Meat Transfer Certificate (MTC), Processing plant production management system, SSSC/Pallet label	
Global Trade Item Number (GTIN)	Encoded in the GS1 barcode, the GTIN is a globally unique 14-digit number used to identify trade items, products, or services.	Yes	Carton label, Meat Messaging Consignment Report, Processing plant production management system, SSSC/Pallet label	For more information visit the GS1 website.
GTIN of Contained Trade Items	Encoded in the GS1 barcode, the GTIN of the contained trade items is a globally unique 14-digit number used to identify trade items, products, or services in the logistic unit.	Yes	Processing plant production management system, SSSC/Pallet label	For more information visit the GS1 website.
Movement date	The date on which livestock or other products (e.g., feed or meat products) were transported between PICs/establishments.	Yes	Bill of lading/Air Waybill, Certificate of Analysis (COA), Delivery Docket/Manifest, Export clearance documentation, Export Health Certificate, Meat Transfer Certificate (MTC), Processing plant production management system	
MSA Licence Number	Any establishment consigning, supplying, or identifying MSA Certified Product must be registered and have a unique MSA Licence Number.	Yes	Processing plant production management system, Receipt of purchase/Tax Invoice	For more information on MSA visit the MLA website.
Net Weight (Kilograms)	Usually encoded in the GS1 barcode, the Net Weight is a variable measure of the trade item e.g., carton, pallet or shipment recorded in kilograms.	Yes	Bill of lading/Air Waybill, Carton label, Export Health Certificate, Meat Messaging Consignment Report, Processing plant production management system, SSSC/Pallet label	For more information visit the GS1 website.
Official mark	Any stamp, seal, label, or mark that is declared by the regulations to be an official mark. An official mark signifies that the product has been inspected by and approved as safe for human consumption by an Authorised Officer.	Yes	Carton label, SSSC/Pallet label	
Order date	This is the date on which the purchase order or contract was raised by the buyer.	Yes	Delivery Docket/Manifest, Processing plant production management system	
Packaging Date	Encoded in the GS1 barcode, the Packaging Date is the date on which the item was packaged and is recorded in the format year, month, day (YYMMDD).	Yes	Carton label, Certificate of Analysis (COA), Processing plant production management system, SSSC/Pallet label	For more information visit the GS1 website.

Packaging Date Range	This includes the oldest and newest packaging dates for the logistic unit.	Yes	Export clearance documentation, Processing plant production management system, SSSC/Pallet label	For more information visit the GS1 website.
Pallet Serial Shipping Container Code (SSCC)	Encoded in the GS1 barcode, this is a unique number which identifies the individual logistic unit i.e., pallet that is assigned by the establishment constructing the unit. The SSCC remains the same for the life of the logistic unit.	Yes	Export clearance documentation, Meat Messaging Consignment Report, Meat Transfer Certificate (MTC), Processing plant production management system, SSSC/Pallet label	For more information visit the GS1 website.
Production Date (YYMMDD)	Encoded in the GS1 barcode, this is the 'kill' or slaughter' date of the product and is recorded in the format year, month, day (YYMMDD).	Yes	Meat Transfer Certificate (MTC), Processing plant production management system	For more information visit the GS1 website.
Recipient Australian Business Number (ABN)	This is an 11-digit registration number, issued by the Australian Tax Office, used to identify businesses.	Yes	Processing plant production management system, Receipt of purchase/Tax Invoice	For more information visit the ATO website.
Seal Serial Number	This is a unique serial number printed on any tamper-evident seal issued by the Department.	Yes	Bill of lading/Air Waybill, Export clearance documentation, Meat Transfer Certificate (MTC), Official seal, Processing plant production management system	For more information visit the Australian Government Federal Register of Legislation.
Seller/Supplier Australian Business Number (ABN)	This is an 11-digit registration number, issued by the Australian Tax Office, used to identify businesses.	Yes	Processing plant production management system, Receipt of purchase/Tax Invoice	For more information visit the ATO website.
Serial Number	Encoded in the GS1 barcode, this is a code, numeric or alphanumeric, assigned to an individual instance of an item for its lifetime.	Yes	Carton label, Processing plant production management system	For more information visit the GS1 website.
Shipping Mark	Also known as a port mark, this is a code comprising of three letters representing the foreign establishment number and the last nine digits of the consignment SSCC.	Yes	Bill of lading/Air Waybill, Certificate of Analysis (COA), Delivery Docket/Manifest, Export Health Certificate, Meat Messaging Consignment Report, Processing plant production management system, SSSC/Pallet label	
To Establishment number	A number issued by Federal and State Authorities to identify the originating site from which meat or meat products were distributed to domestic or export markets. For transfer certificates, the Establishment numbers for both the dispatching and receiving establishments are recorded.	Yes	Export clearance documentation, Meat Transfer Certificate (MTC), Processing plant production management system	
Trade description	This is a collective set of words that says what the product is and may	Yes	Carton label, Delivery Docket/Manifest, Export	

	include information such as species, net weight of product, name and address of establishments, category ciphers, market endorsements, MSA eating quality etc.		clearance documentation, Export Health Certificate, Meat Messaging Consignment Report, Meat Transfer Certificate (MTC), Processing plant production management system, SSCC/Pallet label	
Transfer Certificate number	A unique certificate number issued for traceability purposes.	Yes	Meat Messaging Consignment Report, Meat Transfer Certificate (MTC), Processing plant production management system	
Transport registration number	The registration number of the vehicle in which the animals or product were transported. For shipments of product this will be a shipping container number.	Yes	Bill of lading/Air Waybill, Delivery Docket/Manifest, Export clearance documentation, Export Health Certificate, Meat Messaging Consignment Report, Meat Transfer Certificate (MTC), Processing plant production management system	

5.2.2.9.5 Regulatory and Industry Programs

- Meat Standards Australia (MSA)
- AUS-MEAT
- Australian Meat Industry Council (AMIC)
- Department of Agriculture
- Meat Messaging
- State food authority
- Other data sources

5.2.2.9.6 Supply Chain Node Traceability

Traceability for cartoned and palletised product is limited to the carcasses that have entered the boning room for the production run of cartons that are created. For example, 200 carcasses individually identified with unique carcass tickets enter the boning room for a specific boning run. These carcass tickets are linked to the specific boning run. From these 200 cartons of primal cuts and 200 cartons of trim and other highly mixed products are created. While all cartons are identified with unique serialised carton labels, including a GS1 meat industry barcode, linked to the boning run (and may be packaged into pallets containing unique serialised pallet labels including a GS1 SSCC barcode), it is not readily possible to identify which carcasses are in which cartons as the cartons will contain meat products from different carcasses. If the carcasses were sourced from several different properties, the resulting carton can only be traced to a number of possible carcasses and source properties.

5.2.2.9.7 Data flow diagrams

Table 59. Data flow diagrams for the inputs and outputs of a small stock cold store (carton) system.

Direction	Description
Input	Boning Room to Cold store (Carton)
Output	Cold store (Carton) to Supermarket
Output	Cold store (Carton) to Butcher
Output	Cold store (Carton) to Food Service
Output	Cold store (Carton) to Third-Party Cold Store
Output	Cold store (Carton) to Value Adding

5.2.2.9.7.1 Boning Room to Cold store (Carton)

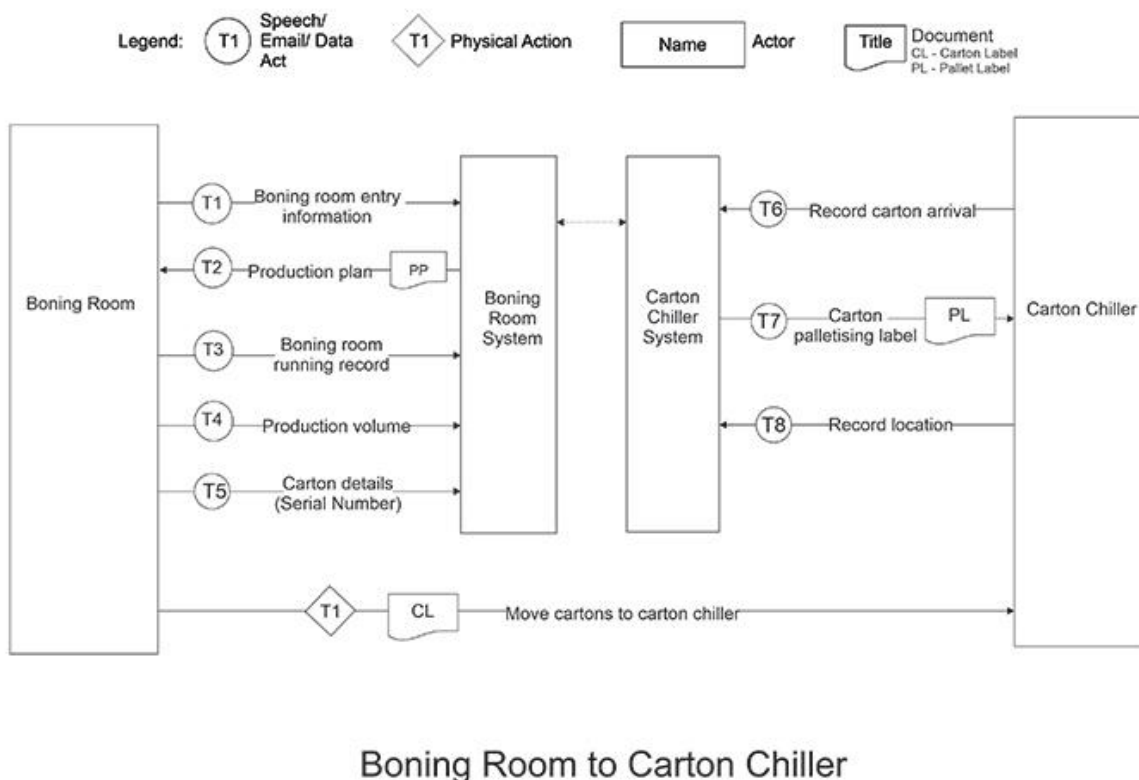

Figure 65. Data or information flows from the boning room to cold store (carton) systems in the small stock supply chain.

5.2.2.9.7.2 Cold store (Carton) to Supermarket

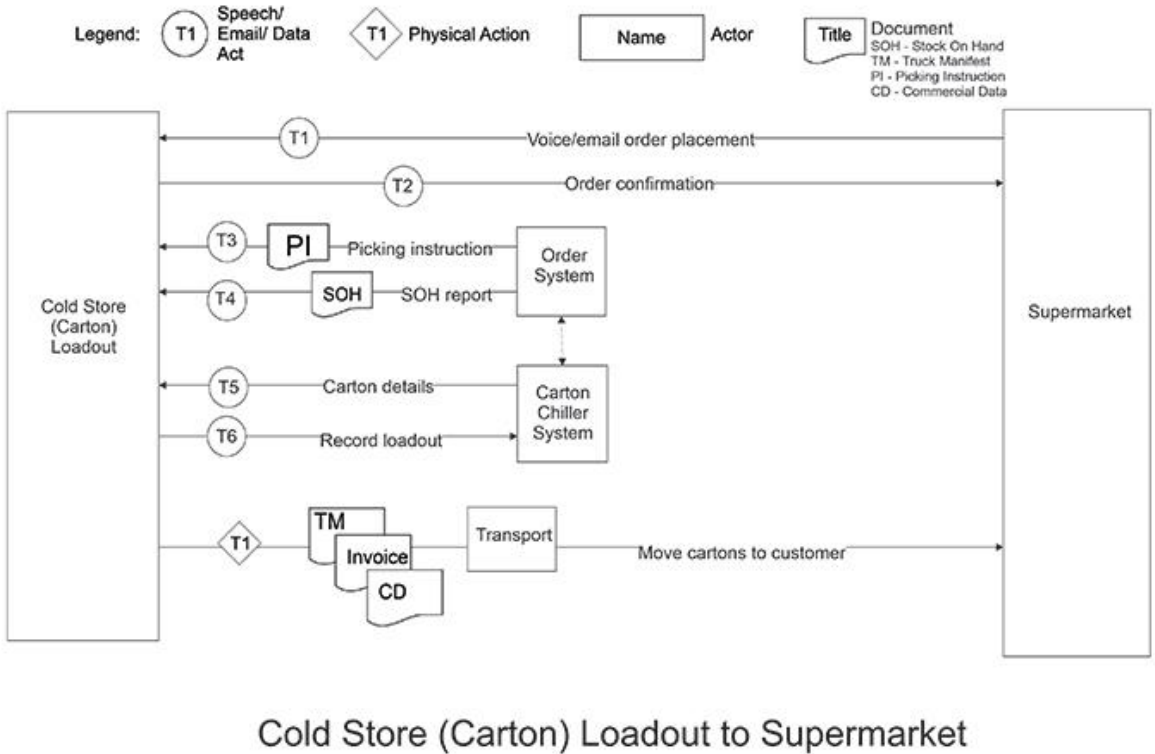

Figure 66. Data or information flows from the cold store (carton) loadout to supermarket systems in the small stock supply chain.

5.2.2.9.7.3 Cold store (Carton) to Butcher

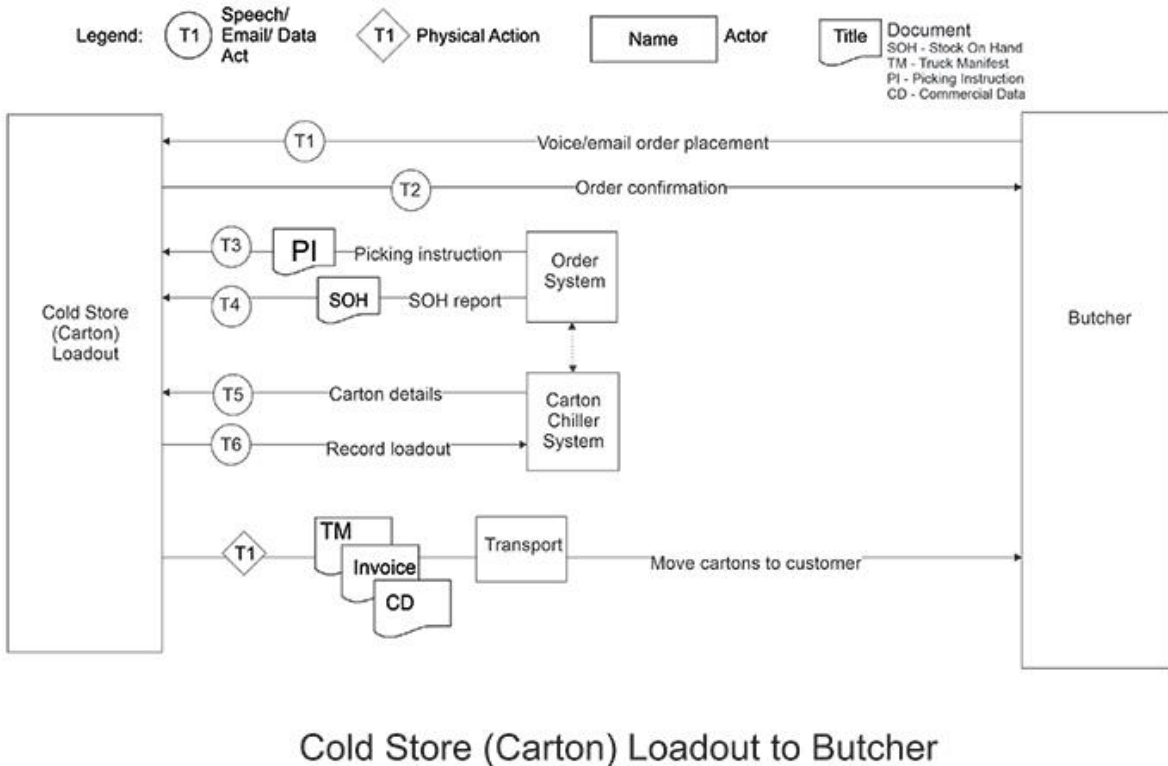
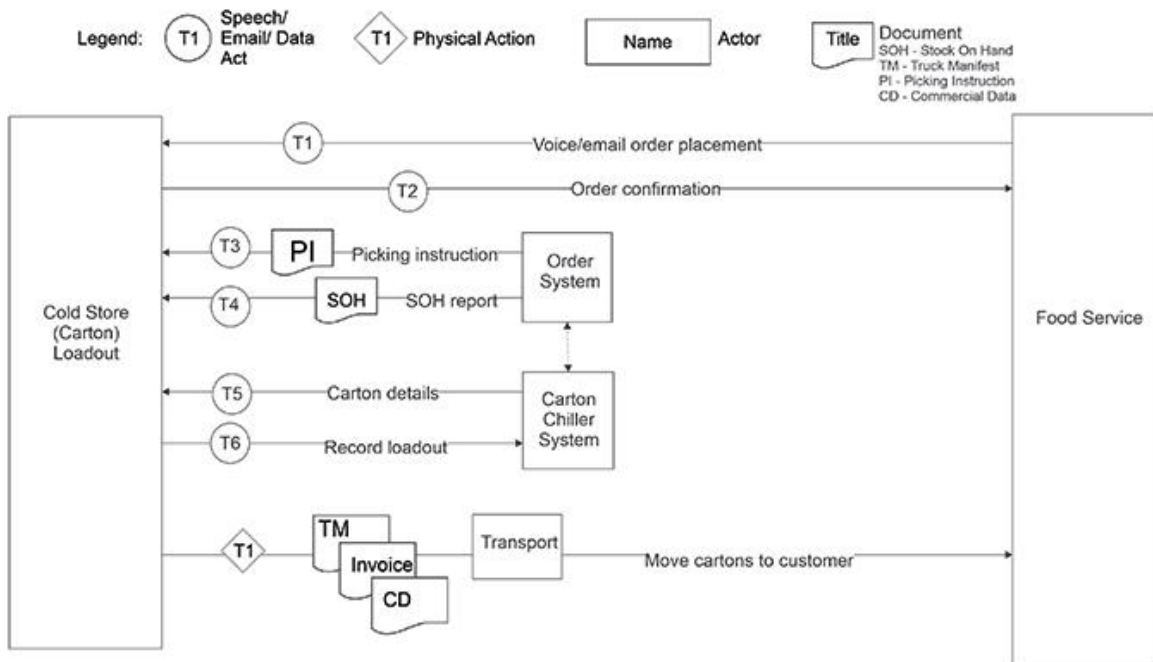

Figure 67. Data or information flows from the cold store (carton) loadout to butcher systems in the small stock supply chain.

5.2.2.9.7.4 Cold store (Carton) to Food Service



Cold Store (Carton) Loadout to Food Service

Figure 68. Data or information flows from the cold store (carton) loadout to food service systems in the small stock supply chain.

5.2.2.9.7.5 Cold store (Carton) to Third-Party Cold Store

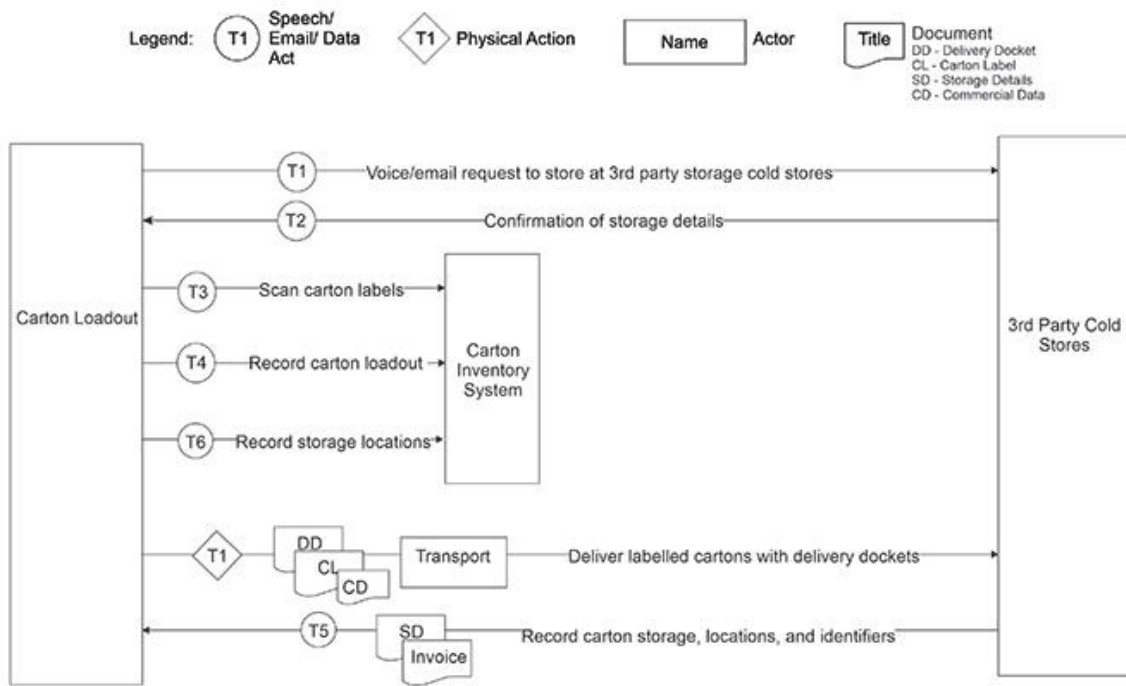

Carton Loadout to 3rd Party Storage Cold Stores

Figure 69. Data or information flows from the cold store (carton) loadout to third-party cold store systems in the small stock supply chain.

5.2.2.9.7.6 Cold store (Carton) to Value Adding

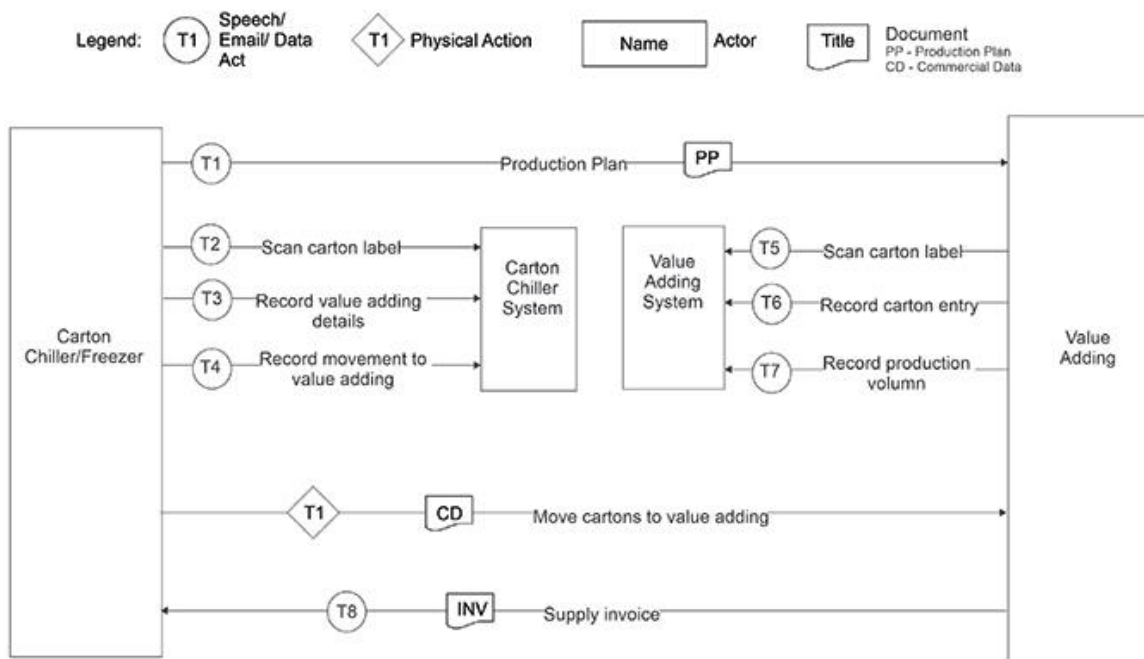

Carton Chiller/Freezer to Value Adding

Figure 70. Data or information flows from the cold store (carton) loadout to value adding systems in the small stock supply chain.

5.2.3 Exporting Country - National distribution

5.2.3.1 Independent boning room

Boning is a process or procedure whereby meat is removed from carcasses or carcass parts, or bone-in or boneless meat cuts are produced. The boning room is the location where these activities occur. An independent boning room is an establishment, separate from a processing establishment, which performs activities the same as that for a boning room integrated into a processing plant.

Typically, carcasses enter the boning room after chilling and refrigerated transport and are broken down into portions and cuts such as primal, sub-primal and trim cuts. This process is very critical, as any errors in cutting can decrease the value of a cut and impact directly on profit. Additionally, there is a high risk of cross-contamination to the cuts and health and safety risks to workers operating the boning room tools and machinery.

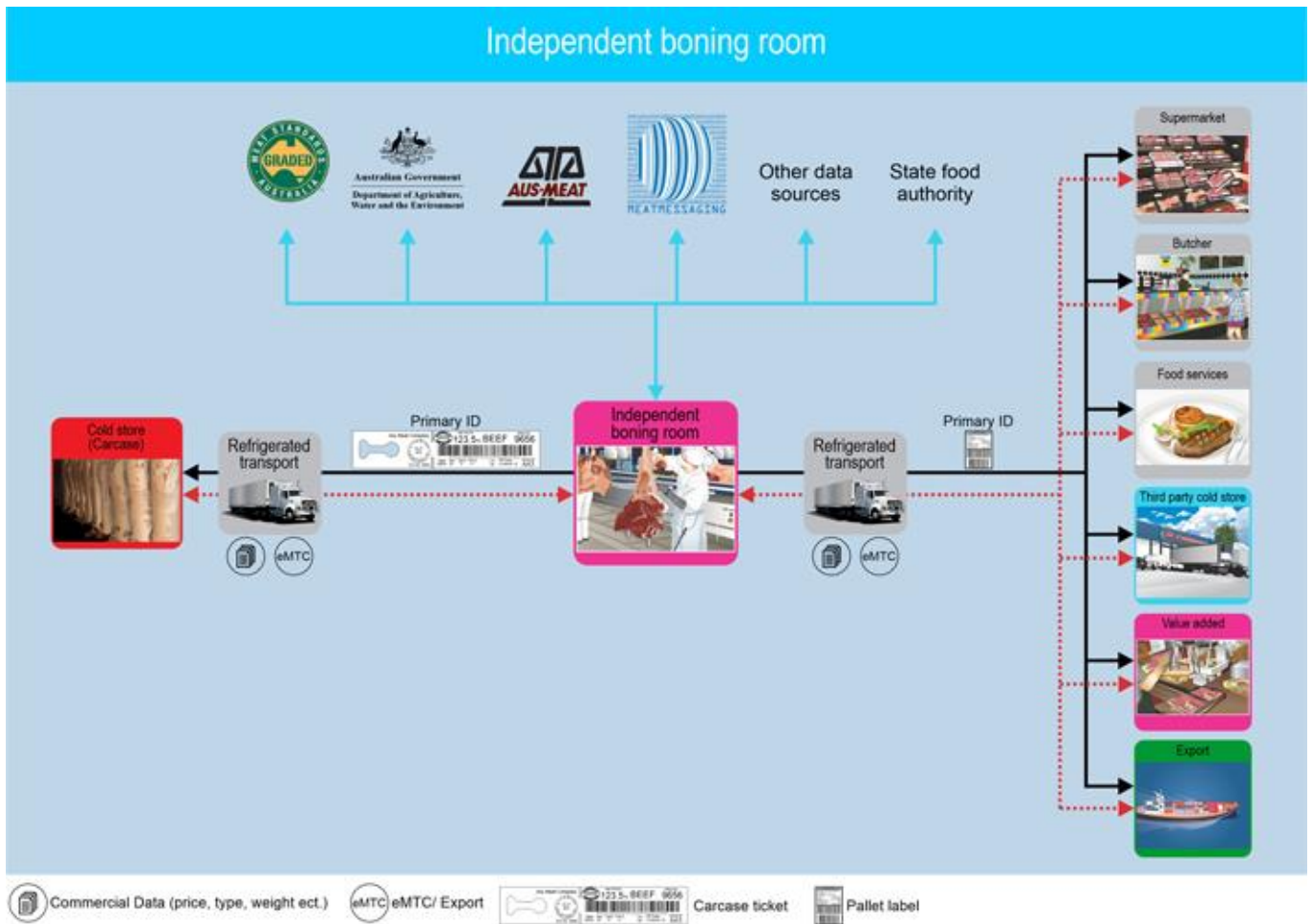

Figure 71. Inputs and outputs of the small stock supply chain independent boning room sector.

5.2.3.1.1 Physical Inputs including Critical Tracking Events (CTEs)

Physical inputs into the boning room include carcasses transported from the cold store (carcase) system. Critical Tracking Event related documentation includes articles pertaining to the identification of individual products e.g., Carcase Ticket, the movement of carcasses e.g., MTC and the purchase of carcasses e.g., Receipt of purchase/Tax Invoice.

Critical Tracking Events (CTEs) are defined as those events which include the growing, receiving, transforming, creating, and shipping of food products. Such events are critical to the traceability of product throughout the supply chain.

The CTEs associated with inputs to the independent boning room system include the receipt of:

- Carcase.

Table 60. Physical inputs and associated Critical Tracking Event related documents for a small stock independent boning room system.

Event related to the inputs	Description of the inputs	Critical Tracking Event (CTE) related documents (including electronic)	More details
Carcase	The body of a slaughtered animal after bleeding. Becomes a	Carcase Ticket, Delivery Docket/Manifest, Independent boning room production management system, Meat Transfer Certificate	

	dressed carcass when hide/skin, head, feet, and offal are removed.	(MTC), MSA Carcass Ticket, Receipt of purchase/Tax Invoice	
--	--	--	--

5.2.3.1.2 Information Inputs including Key Data Elements (KDEs)

Key Data Elements (KDEs) are defined as those elements which are key in identifying and tracing the Critical Tracking Event (CTE). Information inputs or KDEs drawn from CTE documentation accompanying the movement of carcasses to the independent boning room include items such as the establishment number, the date of movement, GS1 barcode application identifiers and the transport registration number.

Table 61. Information inputs, Key Data Elements and Critical Tracking Event related documentation for a small stock independent boning room system.

Attributes (including KDEs)	Description of the Attributes (including KDEs)	Is a KDE	Critical Tracking Event (CTE) related documents (including electronic)	More details
Body number	This is a number assigned to each carcass by the processor for identification purposes.	Yes	Carcass Ticket, Independent Boning Room production management system	
Company/product code	This is an in-house code for the identification of the product in the unit.	Yes	Independent Boning Room production management system, Receipt of purchase/Tax Invoice	
Consignment Serial Shipping Container Code (SSCC)	Encoded in the GS1 barcode, this is a unique number which identifies the individual logistic unit i.e., shipment/message that is assigned by the establishment constructing the unit. The SSCC remains the same for the life of the logistic unit.	Yes	Independent Boning Room production management system, Meat Transfer Certificate (MTC)	For more information visit the GS1 website.
Contract number	This is a unique number allocated to the contract by the seller.	Yes	Delivery Docket/Manifest, Independent Boning Room production management system	
Count of Trade Items	Usually encoded in the GS1 barcode, this is the number of trade items e.g., cartons in the logistic unit.	Yes	Boning Room production management system, Delivery Docket/Manifest, Independent Boning Room production management system	For more information visit the GS1 website.
Date	This is the date of signing or of which a record entry or transaction was made.	Yes	Delivery Docket/Manifest, Independent Boning Room production management system, Meat Transfer Certificate (MTC),	

			Receipt of purchase/Tax Invoice	
Delivery Docket/Manifest number	This is a unique number allocated to the docket for identification purposes.	Yes	Boning Room production management system, Delivery Docket/Manifest, Independent Boning Room production management system	
From Establishment number	A number issued by Federal and State Authorities to identify the originating site from which meat or meat products were distributed to domestic or export markets. For transfer certificates, the Establishment numbers for both the dispatching and receiving establishments are recorded.	Yes	Carcase Ticket, Delivery Docket/Manifest, Independent Boning Room production management system, Meat Transfer Certificate (MTC)	
Global Trade Item Number (GTIN)	Encoded in the GS1 barcode, the GTIN is a globally unique 14-digit number used to identify trade items, products, or services.	Yes	Carcase Ticket, Independent Boning Room production management system	For more information visit the GS1 website.
Lot number	A lot is a number assigned by the processor to each group of livestock consigned to slaughter and is usually vendor specific.	Yes	Carcase Ticket, Independent Boning Room production management system	
Movement date	The date on which livestock or other products (e.g., feed or meat products) were transported between PICs/establishments.	Yes	Delivery Docket/Manifest, Independent Boning Room production management system, Meat Transfer Certificate (MTC)	
MSA eating quality group/grade	This identifies carcasses with similar MSA and eating quality grades, these may align with brands packed by the processor for logistic simplicity. Carcasses are grouped for boning according to eating quality grades.	Yes	Independent Boning Room production management system, MSA Carcase Ticket	For more information on MSA visit the MLA website.
MSA Licence Number	Any establishment consigning, supplying, or identifying MSA Certified Product must be registered and have a unique MSA Licence Number.	Yes	Independent Boning Room production management system, Receipt of purchase/Tax Invoice	For more information on MSA visit the MLA website.
Net Weight (Kilograms)	Usually encoded in the GS1 barcode, the Net Weight is a variable measure of the trade item e.g., carton, pallet or shipment recorded in kilograms.	Yes	Carcase Ticket, Independent Boning Room production management system	For more information visit the GS1 website.
Official mark	Any stamp, seal, label, or mark that is declared by the regulations to be an official mark. An official mark signifies that the product has been inspected by and	Yes	Carcase Ticket, Independent Boning Room production management system	

	approved as safe for human consumption by an Authorised Officer.			
Order date	This is the date on which the purchase order or contract was raised by the buyer.	Yes	Delivery Docket/Manifest, Independent Boning Room production management system	
Pallet Serial Shipping Container Code (SSCC)	Encoded in the GS1 barcode, this is a unique number which identifies the individual logistic unit i.e., pallet that is assigned by the establishment constructing the unit. The SSCC remains the same for the life of the logistic unit.	Yes	Independent Boning Room production management system, Meat Transfer Certificate (MTC)	For more information visit the GS1 website.
Production Date (YYMMDD)	Encoded in the GS1 barcode, this is the 'kill' or slaughter' date of the product and is recorded in the format year, month, day (YYMMDD).	Yes	Carcase Ticket, Independent Boning Room production management system, Meat Transfer Certificate (MTC)	For more information visit the GS1 website.
Recipient Australian Business Number (ABN)	This is an 11-digit registration number, issued by the Australian Tax Office, used to identify businesses.	Yes	Independent Boning Room production management system, Receipt of purchase/Tax Invoice	For more information visit the ATO website.
Seal Serial Number	This is a unique serial number printed on any tamper-evident seal issued by the Department.	Yes	Independent Boning Room production management system, Meat Transfer Certificate (MTC)	For more information visit the Australian Government Federal Register of Legislation.
Seller/Supplier Australian Business Number (ABN)	This is an 11-digit registration number, issued by the Australian Tax Office, used to identify businesses.	Yes	Independent Boning Room production management system, Receipt of purchase/Tax Invoice	For more information visit the ATO website.
Serial Number	Encoded in the GS1 barcode, this is a code, numeric or alphanumeric, assigned to an individual instance of an item for its lifetime.	Yes	Carcase Ticket, Independent Boning Room production management system	For more information visit the GS1 website.
Shipping Mark	Also known as a port mark, this is a code comprising of three letters representing the foreign establishment number and the last nine digits of the consignment SSCC.	Yes	Delivery Docket/Manifest, Independent Boning Room production management system	
To Establishment number	A number issued by Federal and State Authorities to identify the originating site from which meat or meat products were distributed to domestic or export markets. For transfer certificates, the Establishment numbers for both the dispatching and receiving establishments are recorded.	Yes	Independent Boning Room production management system, Meat Transfer Certificate (MTC)	
Trade description	This is a collective set of words that says what the product is and may include	Yes	Carcase Ticket, Delivery	

	information such as species, net weight of product, name and address of establishments, category ciphers, market endorsements, MSA eating quality etc.		Docket/Manifest, Independent Boning Room production management system, Meat Transfer Certificate (MTC)	
Transfer Certificate number	A unique certificate number issued for traceability purposes.	Yes	Independent Boning Room production management system, Meat Transfer Certificate (MTC)	
Transport registration number	The registration number of the vehicle in which the animals or product were transported. For shipments of product this will be a shipping container number.	Yes	Delivery Docket/Manifest, Independent Boning Room production management system, Meat Transfer Certificate (MTC)	

5.2.3.1.3 Physical Outputs including Critical Tracking Events (CTEs)

The outputs of the independent boning room are similar to that of boning rooms located at processing establishments and include carton and palletised product as well as product loaded into shipping containers for transport and export. These products must be accompanied by documentation such as the Delivery Docket/Manifest, Meat Transfer Certificate and Certificate of Analysis when sent direct for export.

Critical Tracking Events (CTEs) are defined as those events which include the growing, receiving, transforming, creating, and shipping of food products. Such events are critical to the traceability of product throughout the supply chain.

The CTEs associated with the outputs of the independent boning room system include the movement of:

- Carton
- Pallet
- Container System Unit

off the property, premises, or supply chain sector.

Table 62. Physical outputs and associated Critical Tracking Event related documents for a small stock independent boning room system.

Event related to the inputs	Description of the inputs	Critical Tracking Event (CTE) related documents (including electronic)	More details
Carton	This is a case, crate, or barrel of product.	Carton label, Delivery Docket/Manifest, Independent boning room production management system, Meat Transfer Certificate (MTC), Official seal, Receipt of purchase/Tax Invoice	
Pallet	A logistic unit which includes a number of cartons or goods items packed together for	Bill of lading/Air Waybill, Certificate of Analysis (COA), Delivery Docket/Manifest, Export Health Certificate, Export Permit, Independent boning room production management system, Meat Transfer Certificate (MTC), Receipt of purchase/Tax Invoice, SSCC/Pallet label	

	transport or storage purposes.		
Container System Unit	A container designed for use as a unit of cargo handling equipment in the transport of goods by aircraft or ship.	Bill of lading/Air Waybill, Certificate of Analysis (COA), Delivery Docket/Manifest, Export Health Certificate, Export Permit, Independent boning room production management system, Meat Transfer Certificate (MTC), Meat Messaging Consignment Report, Official seal, Receipt of purchase/Tax Invoice	

5.2.3.1.4 Information Outputs including Key Data Elements (KDEs)

Key Data Elements (KDEs) are defined as those elements which are key in identifying and tracing the Critical Tracking Event (CTE). Information included on the CTE documentation for independent boning room product includes KDEs such as serial number identifiers for key documentation, production and packaging dates, transportation registration, sending and receiving establishment details and GS1 application identifiers.

Table 63. Information outputs, Key Data Elements and Critical Tracking Event related documentation for a small stock independent boning room system.

Attributes (including KDEs)	Description of the Attributes (including KDEs)	Is a KDE	Critical Tracking Event (CTE) related documents (including electronic)	More details
Analysis Date	This is the date on which a product sample was analysed.	Yes	Certificate of Analysis (COA), Independent Boning Room production management system	
Bill of lading/Air Waybill document number	A unique document number issued for traceability purposes.	Yes	Bill of lading/Air Waybill, Certificate of Analysis (COA), Independent Boning Room production management system	
Certificate of Analysis number	A unique certificate number issued for traceability purposes.	Yes	Certificate of Analysis (COA), Independent Boning Room production management system	
COA test lot identifier	This is a unique identifier allocated to all cartons, pallets and shipping containers for which an analysis sample represents.	Yes	Certificate of Analysis (COA), Independent Boning Room production management system	
Company/product code	This is an in-house code for the identification of the product in the unit.	Yes	Bill of lading/Air Waybill, Carton label, Certificate of Analysis (COA), Independent Boning Room production management system, Receipt of purchase/Tax Invoice, SSCC/Pallet label	
Consignment Serial Shipping Container Code (SSCC)	Encoded in the GS1 barcode, this is a unique number which identifies the individual logistic unit i.e., shipment/message that is assigned by the establishment constructing the unit. The SSCC remains the same for the life of the logistic unit.	Yes	Bill of lading/Air Waybill, Independent Boning Room production management system, Meat Messaging Consignment Report, Meat Transfer Certificate (MTC), SSCC/Pallet label	For more information visit the GS1 website.

Contract number	This is a unique number allocated to the contract by the seller.	Yes	Delivery Docket/Manifest, Independent Boning Room production management system	
Count of Pallets	This is the number of pallets in the logistic unit e.g., container system unit.	Yes	Independent Boning Room production management system, Meat Messaging Consignment Report	
Count of Trade Items	Usually encoded in the GS1 barcode, this is the number of trade items e.g., cartons in the logistic unit.	Yes	Bill of lading/Air Waybill, Delivery Docket/Manifest, Independent Boning Room production management system, Meat Messaging Consignment Report, SSCC/Pallet label	For more information visit the GS1 website.
Date	This is the date of signing or of which a record entry or transaction was made.	Yes	Bill of lading/Air Waybill, Certificate of Analysis (COA), Delivery Docket/Manifest, Independent Boning Room production management system, Meat Messaging Consignment Report, Meat Transfer Certificate (MTC), Receipt of purchase/Tax Invoice	
Delivery Docket/Manifest number	This is a unique number allocated to the docket for identification purposes.	Yes	Delivery Docket/Manifest, Independent Boning Room production management system	
Export Health Certificate Number	A unique number allocated to the health certificate issued for the export consignment for traceability purposes.	Yes	Export Health Certificate, Independent Boning Room production management system, Meat Messaging Consignment Report	For more information visit the Department of Agriculture, Water and the Environment website.
Export Permit Number	A unique permit number is allocated for the export consignment following submission of a correct and validated Request For Permit (RFP) which is then approved by the Secretary.	Yes	Export Permit, Independent Boning Room production management system	For more information visit the Department of Agriculture, Water and the Environment website.
From Establishment number	A number issued by Federal and State Authorities to identify the originating site from which meat or meat products were distributed to domestic or export markets. For transfer certificates, the Establishment numbers for both the dispatching and receiving establishments are recorded.	Yes	Carton label, Certificate of Analysis (COA), Delivery Docket/Manifest, Export Health Certificate, Independent Boning Room production management system, Meat Messaging Consignment Report, Meat Transfer Certificate (MTC), SSCC/Pallet label	

Global Trade Item Number (GTIN)	Encoded in the GS1 barcode, the GTIN is a globally unique 14-digit number used to identify trade items, products, or services.	Yes	Carton label, Independent Boning Room production management system, Meat Messaging Consignment Report, SSCC/Pallet label	For more information visit the GS1 website.
GTIN of Contained Trade Items	Encoded in the GS1 barcode, the GTIN of the contained trade items is a globally unique 14-digit number used to identify trade items, products, or services in the logistic unit.	Yes	Independent Boning Room production management system, SSCC/Pallet label	For more information visit the GS1 website.
Movement date	The date on which livestock or other products (e.g., feed or meat products) were transported between PICs/establishments.	Yes	Bill of lading/Air Waybill, Certificate of Analysis (COA), Delivery Docket/Manifest, Export Health Certificate, Independent Boning Room production management system, Meat Transfer Certificate (MTC)	
MSA Licence Number	Any establishment consigning, supplying, or identifying MSA Certified Product must be registered and have a unique MSA Licence Number.	Yes	Independent Boning Room production management system, Receipt of purchase/Tax Invoice	For more information on MSA visit the MLA website.
Net Weight (Kilograms)	Usually encoded in the GS1 barcode, the Net Weight is a variable measure of the trade item e.g., carton, pallet or shipment recorded in kilograms.	Yes	Bill of lading/Air Waybill, Carton label, Export Health Certificate, Independent Boning Room production management system, Meat Messaging Consignment Report, SSCC/Pallet label	For more information visit the GS1 website.
Official mark	Any stamp, seal, label, or mark that is declared by the regulations to be an official mark. An official mark signifies that the product has been inspected by and approved as safe for human consumption by an Authorised Officer.	Yes	Carton label, Independent Boning Room production management system, SSCC/Pallet label	For more information visit the Department of Agriculture, Water and the Environment website.
Order date	This is the date on which the purchase order or contract was raised by the buyer.	Yes	Delivery Docket/Manifest, Independent Boning Room production management system	
Packaging Date	Encoded in the GS1 barcode, the Packaging Date is the date on which the item was packaged and is recorded in the format year, month, day (YYMMDD).	Yes	Carton label, Certificate of Analysis (COA), Independent Boning Room production management system, SSCC/Pallet label	For more information visit the GS1 website.
Packaging Date Range	This includes the oldest and newest packaging dates for the logistic unit.	Yes	Independent Boning Room production management system, SSCC/Pallet label	For more information visit the GS1 website.
Pallet Serial Shipping	Encoded in the GS1 barcode, this is a unique number which identifies the individual logistic unit i.e., pallet	Yes	Independent Boning Room production management system, Meat Messaging	For more information visit the GS1 website.

Container Code (SSCC)	that is assigned by the establishment constructing the unit. The SSCC remains the same for the life of the logistic unit.		Consignment Report, Meat Transfer Certificate (MTC), SSCC/Pallet label	
Production Date (YYMMDD)	Encoded in the GS1 barcode, this is the 'kill' or slaughter' date of the product and is recorded in the format year, month, day (YYMMDD).	Yes	Independent Boning Room production management system, Meat Transfer Certificate (MTC)	For more information visit the GS1 website.
Recipient Australian Business Number (ABN)	This is an 11-digit registration number, issued by the Australian Tax Office, used to identify businesses.	Yes	Independent Boning Room production management system, Receipt of purchase/Tax Invoice	For more information visit the ATO website.
Seal Serial Number	This is a unique serial number printed on any tamper-evident seal issued by the Department.	Yes	Bill of lading/Air Waybill, Independent Boning Room production management system, Meat Transfer Certificate (MTC), Official seal	For more information visit the Australian Government Federal Register of Legislation.
Seller/Supplier Australian Business Number (ABN)	This is an 11-digit registration number, issued by the Australian Tax Office, used to identify businesses.	Yes	Independent Boning Room production management system, Receipt of purchase/Tax Invoice	For more information visit the ATO website.
Serial Number	Encoded in the GS1 barcode, this is a code, numeric or alphanumeric, assigned to an individual instance of an item for its lifetime.	Yes	Carton label, Independent Boning Room production management system	For more information visit the GS1 website.
Shipping Mark	Also known as a port mark, this is a code comprising of three letters representing the foreign establishment number and the last nine digits of the consignment SSCC.	Yes	Bill of lading/Air Waybill, Certificate of Analysis (COA), Delivery Docket/Manifest, Export Health Certificate, Independent Boning Room production management system, Meat Messaging Consignment Report, SSCC/Pallet label	
To Establishment number	A number issued by Federal and State Authorities to identify the originating site from which meat or meat products were distributed to domestic or export markets. For transfer certificates, the Establishment numbers for both the dispatching and receiving establishments are recorded.	Yes	Independent Boning Room production management system, Meat Transfer Certificate (MTC)	
Trade description	This is a collective set of words that says what the product is and may include information such as species, net weight of product, name and address of establishments, category ciphers, market endorsements, MSA eating quality etc.	Yes	Carton label, Delivery Docket/Manifest, Export Health Certificate, Independent Boning Room production management system, Meat Messaging Consignment Report, Meat	

			Transfer Certificate (MTC), SSCC/Pallet label	
Transfer Certificate number	A unique certificate number issued for traceability purposes.	Yes	Independent Boning Room production management system, Meat Messaging Consignment Report, Meat Transfer Certificate (MTC)	
Transport registration number	The registration number of the vehicle in which the animals or product were transported. For shipments of product this will be a shipping container number.	Yes	Bill of lading/Air Waybill, Delivery Docket/Manifest, Export Health Certificate, Independent Boning Room production management system, Meat Messaging Consignment Report, Meat Transfer Certificate (MTC)	

5.2.3.1.5 Regulatory and Industry Programs

- Meat Standards Australia (MSA)
- AUS-MEAT
- Australian Meat Industry Council (AMIC)
- Department of Agriculture
- Meat Messaging
- State food authority
- Other data sources

5.2.3.1.6 Supply Chain Node Traceability

Traceability for cartoned and palletised product is limited to the carcasses that have entered the boning room for the production run of cartons that are created. For example, 200 carcasses individually identified with unique carcass tickets enter the boning room for a specific boning run. These carcass tickets are linked to the specific boning run. From these 200 cartons of primal cuts and 200 cartons of trim and other highly mixed products are created. While all cartons are identified with unique serialised carton labels, including a GS1 meat industry barcode, linked to the boning run (and may be packaged into pallets containing unique serialised pallet labels including a GS1 SSCC barcode), it is not readily possible to identify which carcasses are in which cartons as the cartons will contain meat products from different carcasses. If the carcasses were sourced from several different properties, the resulting carton can only be traced to a number of possible carcasses and source properties.

5.2.3.1.7 Data flow diagrams

Table 64: Data flow diagrams for the inputs and outputs of a small stock independent boning room

Direction	Description
Input	Cold Store (Carcass) to Independent Boning Room
Output	Independent Boning Room to Supermarket
Output	Independent Boning Room to Butcher

Output	Independent Boning Room to Food Services
Output	Independent Boning Room to Third Party Cold Store
Output	Independent Boning Room to Value Added
Output	Independent Boning Room to Export

5.2.3.1.7.1 Cold Store (Carcase) to Independent Boning Room

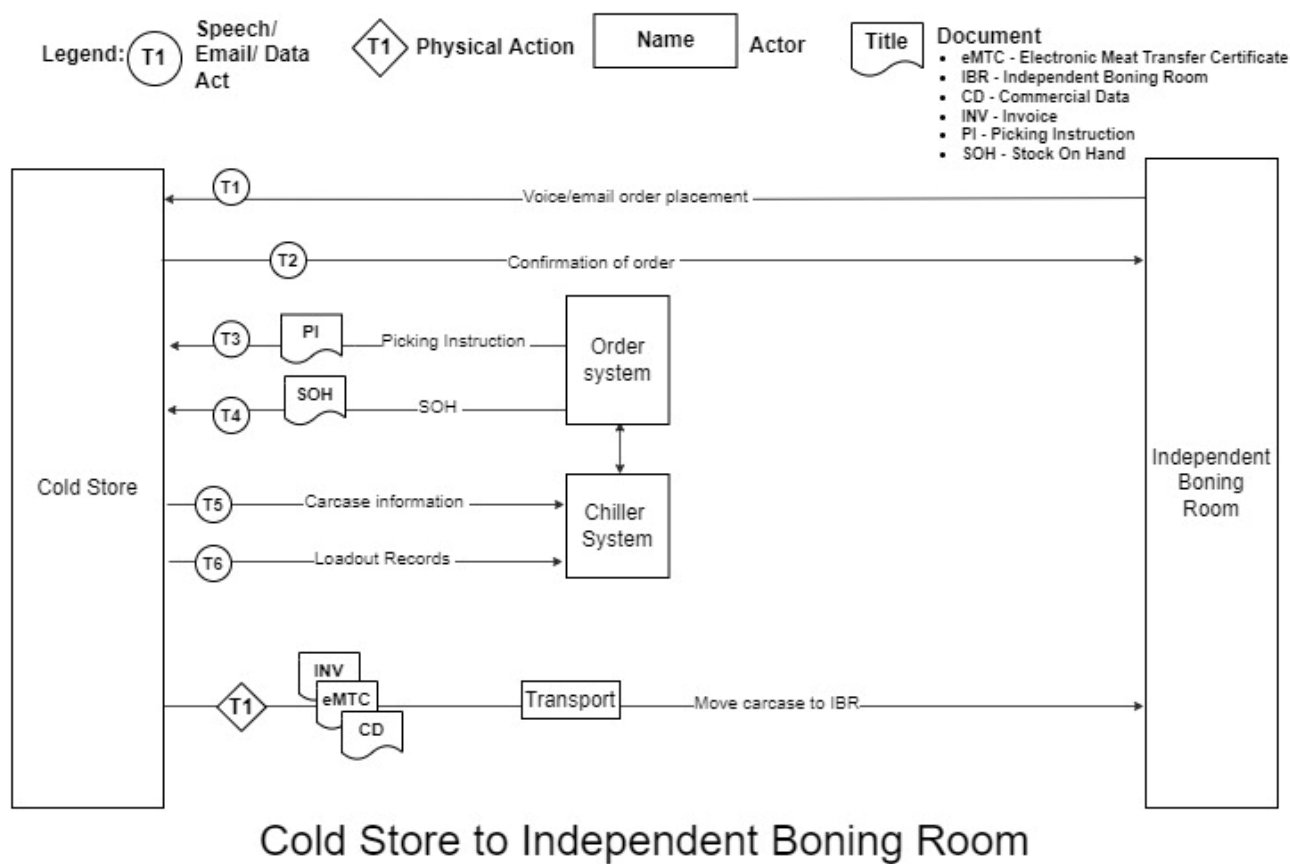

Figure 72: Data or information flows from the cold store to independent boning room in the small stock supply chain.

5.2.3.1.7.2 Independent Boning Room to Supermarket

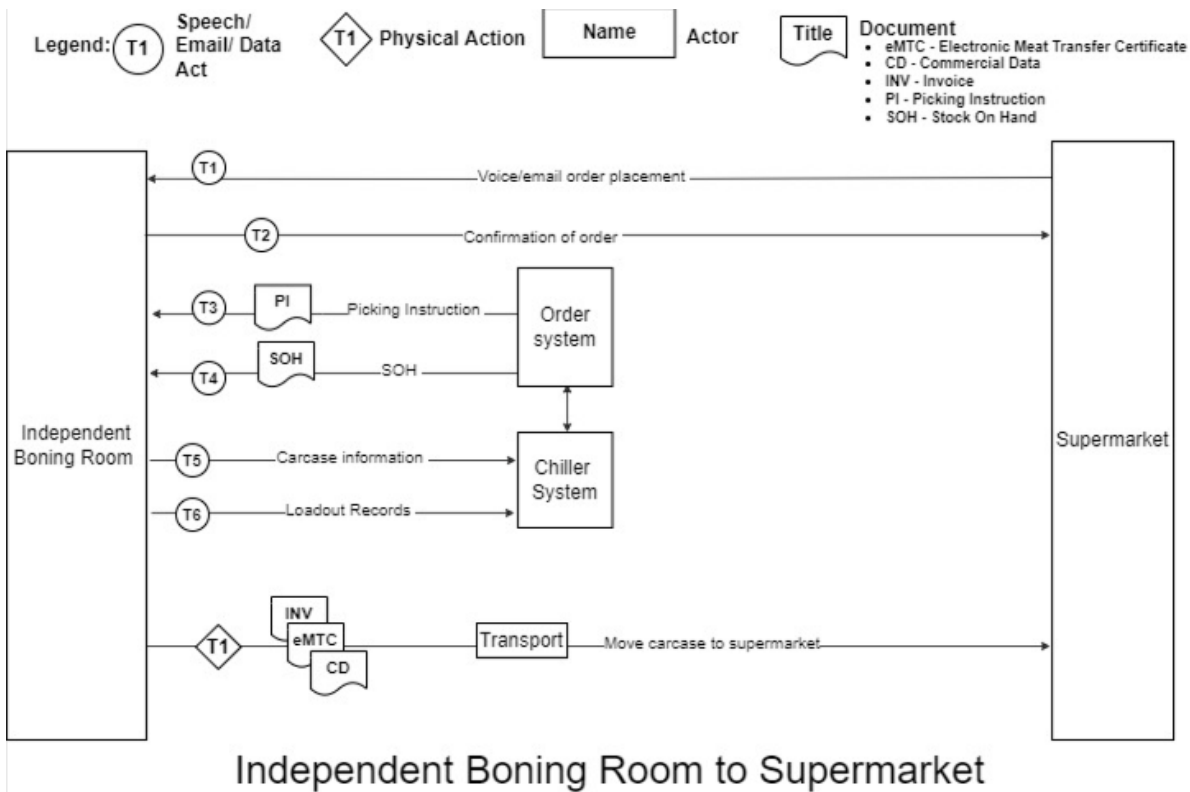

Figure 73. Data or information flows from the independent boning room to supermarket in the small stock supply chain.

5.2.3.1.7.3 Independent Boning Room to Butcher

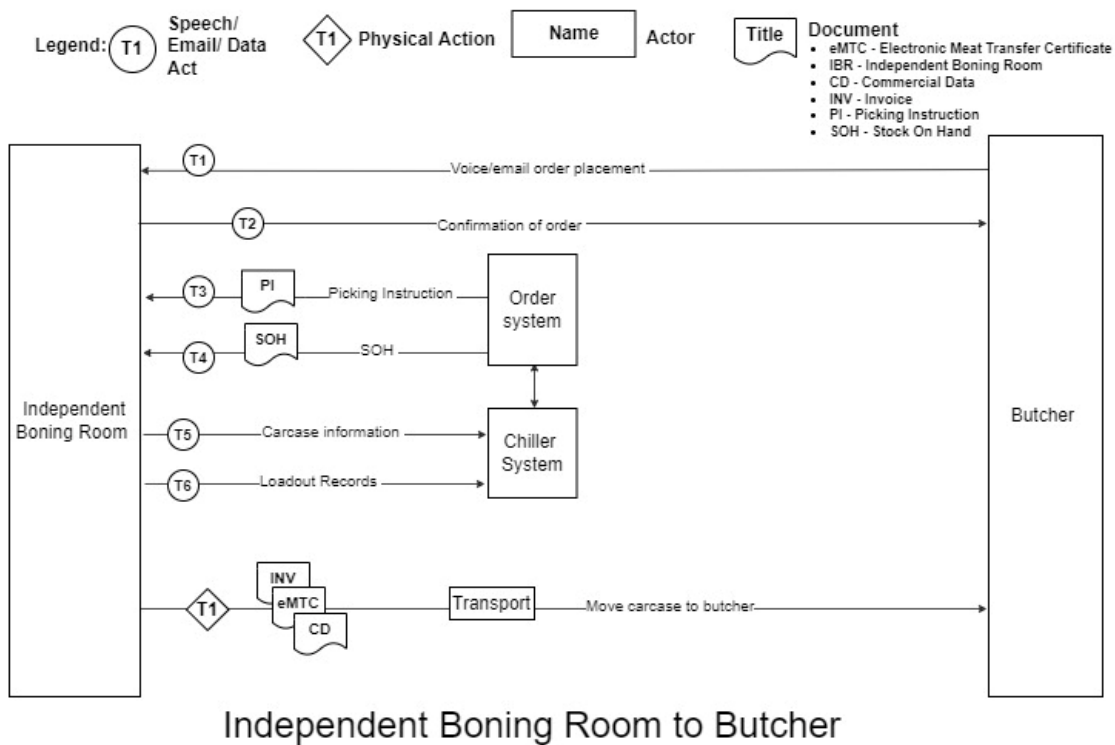

Figure 74. Data or information flows from the independent boning room to butcher in the small stock supply chain.

5.2.3.1.7.4 Independent Boning Room to Food Services

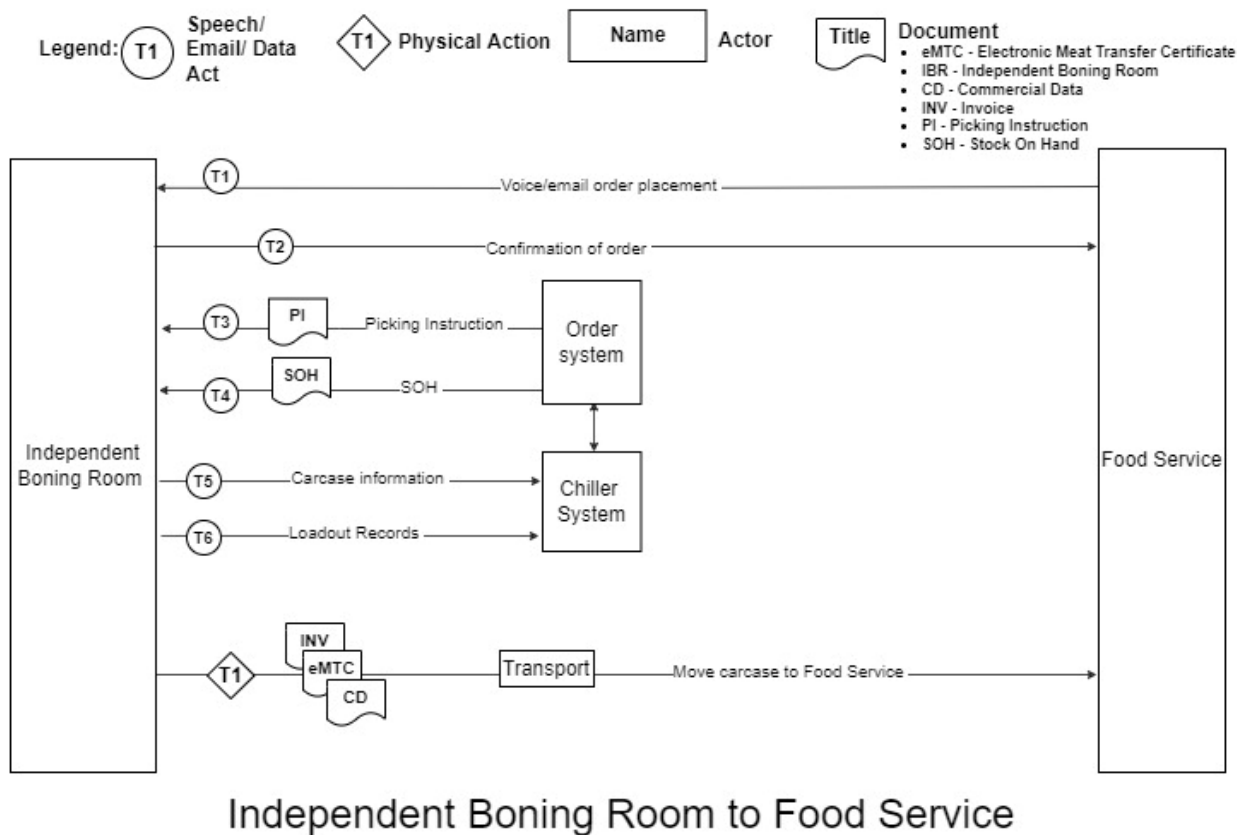

Figure 75. Data or information flows from the independent boning room to supermarket in the small stock supply chain.

5.2.3.1.7.5 Independent Boning Room to Third Party Cold Store

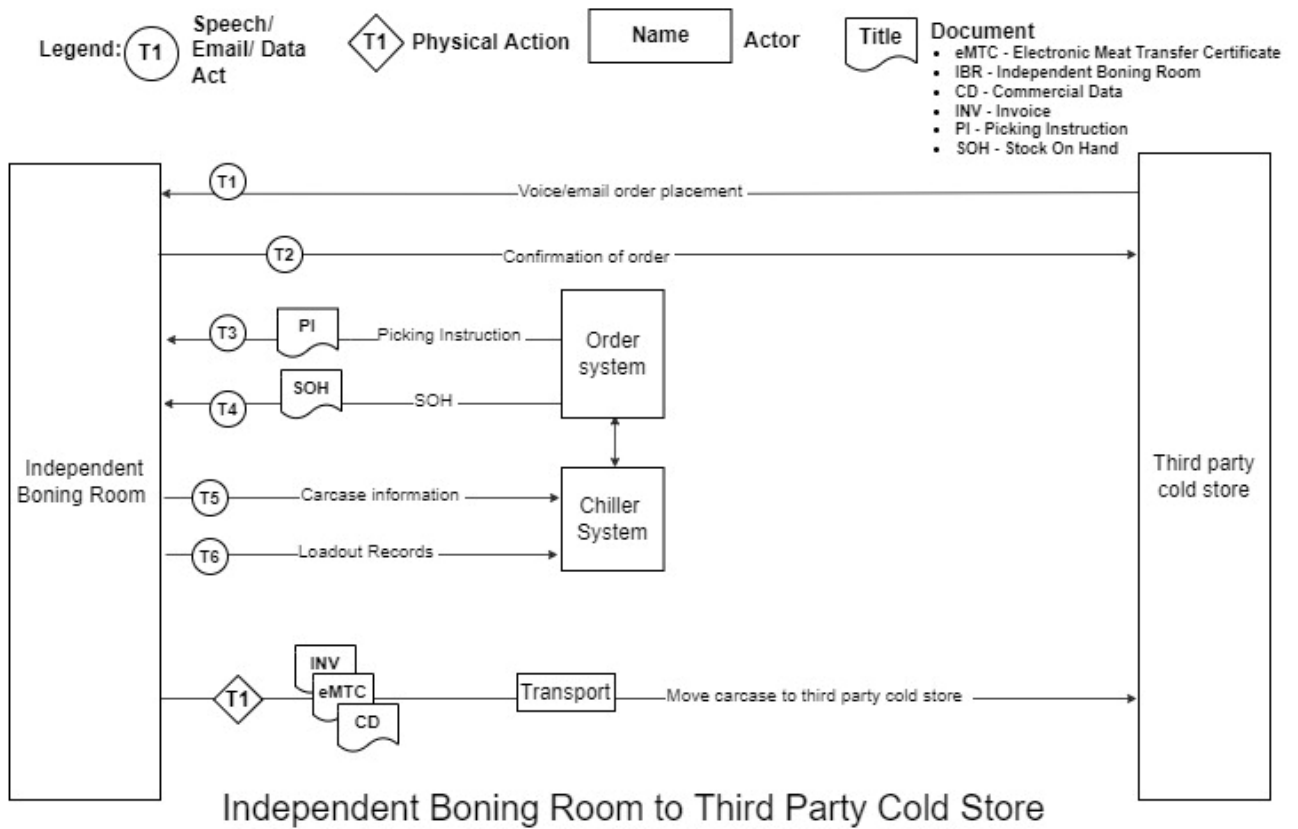
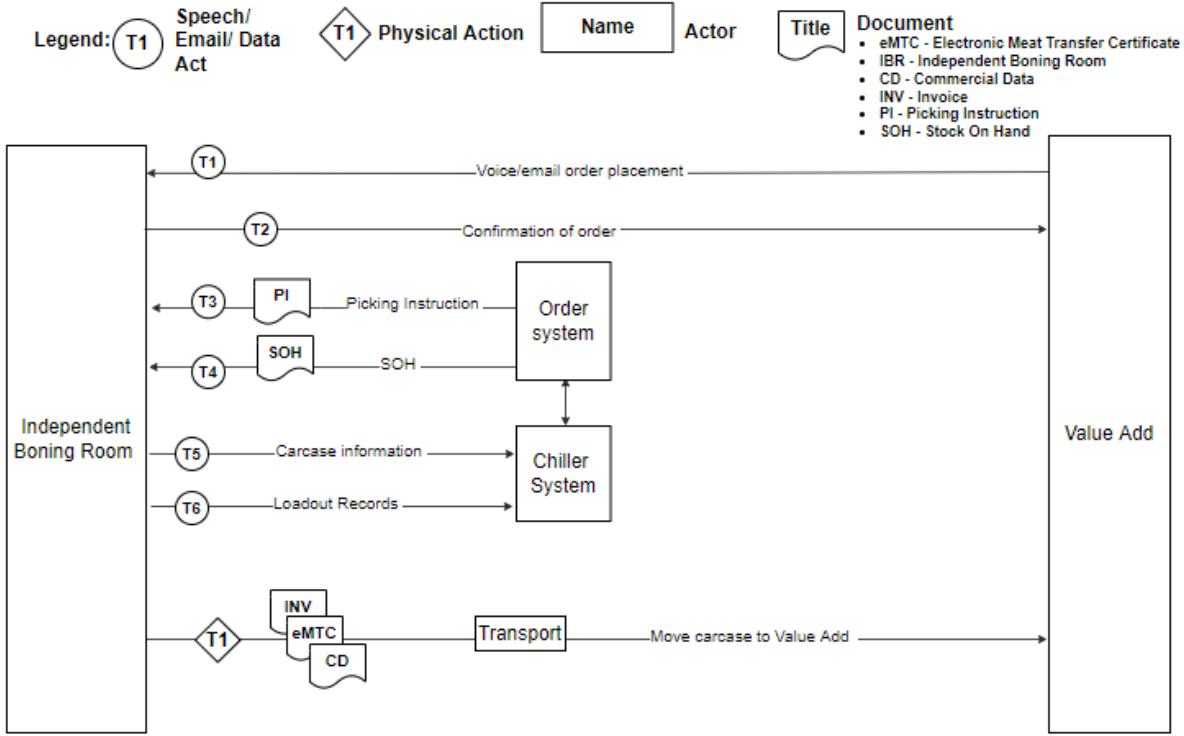

Figure 76. Data or information flows from the independent boning room to butcher in the small stock supply chain.

5.2.3.1.7.6 Independent Boning Room to Value Added



Independent Boning Room to Value Added

Figure 77. Data or information flows from the independent boning room to butcher in the small stock supply chain.

5.2.3.1.7.7 Independent Boning Room to Export

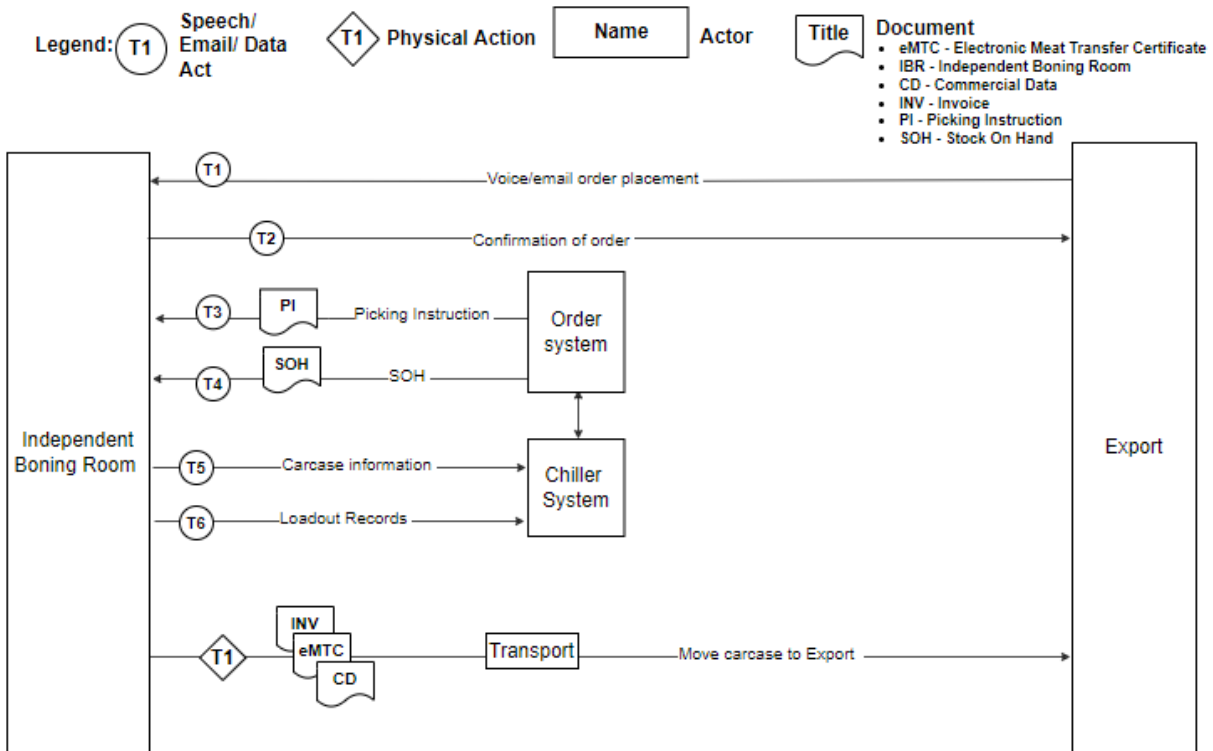

Independent Boning Room to Export

Figure 78. Data or information flows from the independent boning room to butcher in the small stock supply chain.

5.2.3.2 Value-added

Value-adding includes any process or service in the supply chain that adds to or enhances the value of products to consumers and typically the profitability of raw meat products. This may be simply providing a new variety of cuts, changing the presentation of products, or adding additional ingredients to create new products or enhance the profitability of raw products. Value-adding may also include the processing of offal and raw products for sale. Typically, value adders receive carcasse or cartoned product from processor cold stores, or from independent boning rooms or third-party cold store facilities via refrigerated transport. Typically, value adders receive carcasse or cartoned product from processor cold stores, or from independent boning rooms or third-party cold store facilities via refrigerated transport.

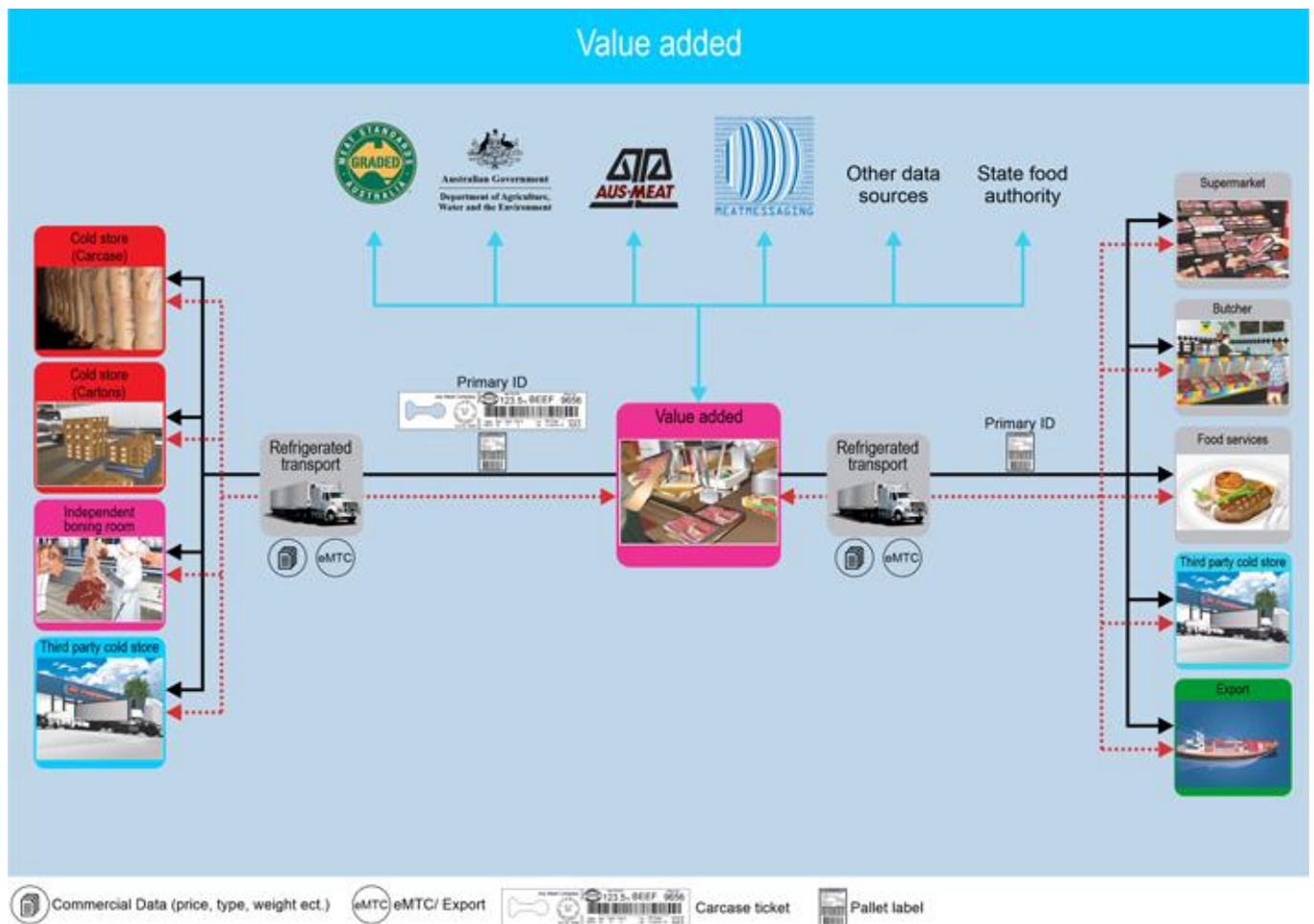

Figure 79. Inputs and outputs of the small stock supply chain value-added sector.

5.2.3.2.1 Physical Inputs including Critical Tracking Events (CTEs)

Inputs into the value-added system include raw meat products such as carcasses, carton, and palletised items. Where additional ingredients are added to the product such as those used for marinade, these are also inputs to the system. Documentation associated with the movement of product into the value-added system may include Delivery Dockets, MTCs, Receipt of purchase/Tax Invoice etc.

Critical Tracking Events (CTEs) are defined as those events which include the growing, receiving, transforming, creating and shipping of food products. Such events are critical to the traceability of product throughout the supply chain.

The CTEs associated with inputs to the value-added system include the receipt of:

- Carcasse

- Carton
- Pallet
- Product additives.

Table 65. Physical inputs and associated Critical Tracking Event related documents for a small stock value-added system.

Event related to the inputs	Description of the inputs	Critical Tracking Event (CTE) related documents (including electronic)	More details
Carcase	The body of a slaughtered animal after bleeding. Becomes a dressed carcass when hide/skin, head, feet, and offal are removed.	Carcass Ticket, Delivery Docket/Manifest, Meat Transfer Certificate (MTC), MSA Carcass Ticket, Receipt of purchase/Tax Invoice, Value Added production management system	
Carton	This is a case, crate, or barrel of product.	Carton label, Delivery Docket/Manifest, Meat Transfer Certificate (MTC), Official seal, Receipt of purchase/Tax Invoice, Value Added production management system	
Pallet	A logistic unit which includes a number of cartons or goods items packed together for transport or storage purposes.	Delivery Docket/Manifest, Meat Transfer Certificate (MTC), Receipt of purchase/Tax Invoice, SSCC/Pallet label, Value Added production management system	
Product additives	These are ingredients or additives used to enhance the value of raw meat product.	Receipt of purchase/Tax Invoice, Value Added production management system	

5.2.3.2.2 Information Inputs including Key Data Elements (KDEs)

Key Data Elements (KDEs) are defined as those elements which are key in identifying and tracing the Critical Tracking Event (CTE). Key Data Elements drawn from Critical Tracking Event documentation range from carcass body numbers to delivery docket numbers to application identifiers included in the GS1 barcode on the carton or pallet label. All of this information is recorded in the value adder's production management system for product traceability purposes.

Table 66. Information inputs, Key Data Elements and Critical Tracking Event related documentation for a small stock value-added system.

Attributes (including KDEs)	Description of the Attributes (including KDEs)	Is a KDE	Critical Tracking Event (CTE) related documents (including electronic)	More details
Body number	This is a number assigned to each carcass by the processor for identification purposes.	Yes	Carcass Ticket, Value Added production management system	
Company/product code	This is an in-house code for the identification of the product in the unit.	Yes	Carton label, Receipt of purchase/Tax Invoice, SSCC/Pallet label, Value Added production management system	
Consignment Serial Shipping	Encoded in the GS1 barcode, this is a unique number which identifies the	Yes	Meat Transfer Certificate (MTC),	For more information

Container Code (SSCC)	individual logistic unit i.e., shipment/message that is assigned by the establishment constructing the unit. The SSCC remains the same for the life of the logistic unit.		SSCC/Pallet label, Value Added production management system	visit the GS1 website.
Contract number	This is a unique number allocated to the contract by the seller.	Yes	Delivery Docket/Manifest, Value Added production management system	
Count of Trade Items	Usually encoded in the GS1 barcode, this is the number of trade items e.g., cartons in the logistic unit.	Yes	Delivery Docket/Manifest, SSCC/Pallet label, Value Added production management system	For more information visit the GS1 website.
Date	This is the date of signing or of which a record entry or transaction was made.	Yes	Delivery Docket/Manifest, Meat Transfer Certificate (MTC), Receipt of purchase/Tax Invoice, Value Added production management system	
Delivery Docket/Manifest number	This is a unique number allocated to the docket for identification purposes.	Yes	Delivery Docket/Manifest, Value Added production management system	
From Establishment number	A number issued by Federal and State Authorities to identify the originating site from which meat or meat products were distributed to domestic or export markets. For transfer certificates, the Establishment numbers for both the dispatching and receiving establishments are recorded.	Yes	Carcase Ticket, Carton label, Delivery Docket/Manifest, Meat Transfer Certificate (MTC), SSCC/Pallet label, Value Added production management system	
Global Trade Item Number (GTIN)	Encoded in the GS1 barcode, the GTIN is a globally unique 14-digit number used to identify trade items, products, or services.	Yes	Carcase Ticket, Carton label, SSCC/Pallet label, Value Added production management system	For more information visit the GS1 website.
GTIN of Contained Trade Items	Encoded in the GS1 barcode, the GTIN of the contained trade items is a globally unique 14-digit number used to identify trade items, products, or services in the logistic unit.	Yes	SSCC/Pallet label, Value Added production management system	For more information visit the GS1 website.
Lot number	A lot is a number assigned by the processor to each group of livestock consigned to slaughter and is usually vendor specific.	Yes	Carcase Ticket, Value Added production management system	
Movement date	The date on which livestock or other products (e.g., feed or meat products)	Yes	Delivery Docket/Manifest, Meat	

	were transported between PICs/establishments.		Transfer Certificate (MTC), Value Added production management system	
MSA eating quality group/grade	This identifies carcasses with similar MSA and eating quality grades, these may align with brands packed by the processor for logistic simplicity. Carcasses are grouped for boning according to eating quality grades.	Yes	MSA Carcase Ticket, Value Added production management system	For more information on MSA visit the MLA website.
MSA Licence Number	Any establishment consigning, supplying, or identifying MSA Certified Product must be registered and have a unique MSA Licence Number.	Yes	Receipt of purchase/Tax Invoice, Value Added production management system	For more information on MSA visit the MLA website.
Net Weight (Kilograms)	Usually encoded in the GS1 barcode, the Net Weight is a variable measure of the trade item e.g., carton, pallet or shipment recorded in kilograms.	Yes	Carcase Ticket, Carton label, SSCC/Pallet label, Value Added production management system	For more information visit the GS1 website.
Official mark	Any stamp, seal, label, or mark that is declared by the regulations to be an official mark. An official mark signifies that the product has been inspected by and approved as safe for human consumption by an Authorised Officer.	Yes	Carcase Ticket, Carton label, SSCC/Pallet label, Value Added production management system	
Order date	This is the date on which the purchase order or contract was raised by the buyer.	Yes	Delivery Docket/Manifest, Value Added production management system	
Packaging Date	Encoded in the GS1 barcode, the Packaging Date is the date on which the item was packaged and is recorded in the format year, month, day (YYMMDD).	Yes	Carton label, SSCC/Pallet label, Value Added production management system	For more information visit the GS1 website.
Packaging Date Range	This includes the oldest and newest packaging dates for the logistic unit.	Yes	SSCC/Pallet label, Value Added production management system	For more information visit the GS1 website.
Pallet Serial Shipping Container Code (SSCC)	Encoded in the GS1 barcode, this is a unique number which identifies the individual logistic unit i.e., pallet that is assigned by the establishment constructing the unit. The SSCC remains the same for the life of the logistic unit.	Yes	Meat Transfer Certificate (MTC), SSCC/Pallet label, Value Added production management system	For more information visit the GS1 website.
Production Date (YYMMDD)	Encoded in the GS1 barcode, this is the 'kill' or slaughter' date of the product and is recorded in the format year, month, day (YYMMDD).	Yes	Carcase Ticket, Meat Transfer Certificate (MTC), Value Added production management system	For more information visit the GS1 website.

Recipient Australian Business Number (ABN)	This is an 11-digit registration number, issued by the Australian Tax Office, used to identify businesses.	Yes	Receipt of purchase/Tax Invoice, Value Added production management system	For more information visit the ATO website.
Seal Serial Number	This is a unique serial number printed on any tamper-evident seal issued by the Department.	Yes	Meat Transfer Certificate (MTC), Official seal, Value Added production management system	For more information visit the Australian Government Federal Register of Legislation.
Seller/Supplier Australian Business Number (ABN)	This is an 11-digit registration number, issued by the Australian Tax Office, used to identify businesses.	Yes	Receipt of purchase/Tax Invoice, Value Added production management system	For more information visit the ATO website.
Serial Number	Encoded in the GS1 barcode, this is a code, numeric or alphanumeric, assigned to an individual instance of an item for its lifetime.	Yes	Carcase Ticket, Carton label, Value Added production management system	For more information visit the GS1 website.
Shipping Mark	Also known as a port mark, this is a code comprising of three letters representing the foreign establishment number and the last nine digits of the consignment SSCC.	Yes	Delivery Docket/Manifest, SSCC/Pallet label, Value Added production management system	
To Establishment number	A number issued by Federal and State Authorities to identify the originating site from which meat or meat products were distributed to domestic or export markets. For transfer certificates, the Establishment numbers for both the dispatching and receiving establishments are recorded.	Yes	Meat Transfer Certificate (MTC), Value Added production management system	
Trade description	This is a collective set of words that says what the product is and may include information such as species, net weight of product, name and address of establishments, category ciphers, market endorsements, MSA eating quality etc.	Yes	Carcase Ticket, Carton label, Delivery Docket/Manifest, Meat Transfer Certificate (MTC), SSCC/Pallet label, Value Added production management system	
Transfer Certificate number	A unique certificate number issued for traceability purposes.	Yes	Meat Transfer Certificate (MTC), Value Added production management system	
Transport registration number	The registration number of the vehicle in which the animals or product were transported. For shipments of product this will be a shipping container number.	Yes	Delivery Docket/Manifest, Meat Transfer Certificate (MTC), Value Added production management system	

5.2.3.2.3 Physical Outputs including Critical Tracking Events (CTEs)

The outputs of the value-added system include altered meat product, with increased value, that is packaged into cartons, pallets, or shipping containers for distribution. Additional documentation required for the movement of product for export may include a Bill of lading/Air Waybill, Export Health Certificate, Export Permit and Certificate of Analysis.

Critical Tracking Events (CTEs) are defined as those events which include the growing, receiving, transforming, creating, and shipping of food products. Such events are critical to the traceability of product throughout the supply chain.

The CTEs associated with the outputs of the value-added system include the movement of:

- Carton
- Pallet
- Container System Unit

off the property, premises, or supply chain sector.

Table 67. Physical outputs and associated Critical Tracking Event related documents for a small stock value-adding system.

Event related to the inputs	Description of the inputs	Critical Tracking Event (CTE) related documents (including electronic)	More details
Carton	This is a case, crate or barrel of product.	Carton label, Delivery Docket/Manifest, Meat Transfer Certificate (MTC), Official seal, Receipt of purchase/Tax Invoice, Value Added production management system	
Pallet	A logistic unit which includes a number of cartons or goods items packed together for transport or storage purposes.	Bill of lading/Air Waybill, Certificate of Analysis (COA), Delivery Docket/Manifest, Export Health Certificate, Export Permit Meat Transfer Certificate (MTC), Receipt of purchase/Tax Invoice, SSCC/Pallet label, Value Added production management system	
Container System Unit	A container designed for use as a unit of cargo handling equipment in the transport of goods by aircraft or ship.	Bill of lading/Air Waybill, Certificate of Analysis (COA), Delivery Docket/Manifest, Export Health Certificate, Export Permit, Meat Messaging Consignment Report, Meat Transfer Certificate (MTC), Official seal, Receipt of purchase/Tax Invoice, Value Added production management system	

5.2.3.2.4 Information Outputs including Key Data Elements (KDEs)

Key Data Elements (KDEs) are defined as those elements which are key in identifying and tracing the Critical Tracking Event (CTE). Key Data Elements from value added Critical Tracking Event related documentation will be stored in the value adder’s production management system. Such information may include, but not be limited to, GS1 barcode application identifiers, movement dates, product net weight, seal serial numbers and transfer certificate numbers.

Table 68. Information outputs, Key Data Elements and Critical Tracking Event related documentation for a small stock value-added system.

Attributes (including KDEs)	Description of the Attributes (including KDEs)	Is a KDE	Critical Tracking Event (CTE) related documents (including electronic)	More details
Analysis Date	This is the date on which a product sample was analysed.	Yes	Certificate of Analysis (COA), Value Added production management system	
Bill of lading/Air Waybill document number	A unique document number issued for traceability purposes.	Yes	Bill of lading/Air Waybill, Certificate of Analysis (COA), Value Added production management system	
Certificate of Analysis number	A unique certificate number issued for traceability purposes.	Yes	Certificate of Analysis (COA), Value Added production management system	
COA test lot identifier	This is a unique identifier allocated to all cartons, pallets, and shipping containers for which an analysis sample represents.	Yes	Certificate of Analysis (COA), Value Added production management system	
Company/product code	This is an in-house code for the identification of the product in the unit.	Yes	Bill of lading/Air Waybill, Carton label, Certificate of Analysis (COA), Receipt of purchase/Tax Invoice, SSCC/Pallet label, Value Added production management system	
Consignment Serial Shipping Container Code (SSCC)	Encoded in the GS1 barcode, this is a unique number which identifies the individual logistic unit i.e., shipment/message that is assigned by the establishment constructing the unit. The SSCC remains the same for the life of the logistic unit.	Yes	Bill of lading/Air Waybill, Meat Messaging Consignment Report, Meat Transfer Certificate (MTC), SSCC/Pallet label, Value Added production management system	For more information visit the GS1 website.
Contract number	This is a unique number allocated to the contract by the seller.	Yes	Delivery Docket/Manifest, Value Added production management system	
Count of Pallets	This is the number of pallets in the logistic unit e.g., container system unit.	Yes	Meat Messaging Consignment Report, Value Added production management system	
Count of Trade Items	Usually encoded in the GS1 barcode, this is the number of trade items e.g., cartons in the logistic unit.	Yes	Bill of lading/Air Waybill, Delivery Docket/Manifest, Meat Messaging Consignment Report, SSCC/Pallet label, Value Added production management system	For more information visit the GS1 website.
Date	This is the date of signing or of which a record entry or transaction was made.	Yes	Bill of lading/Air Waybill, Certificate of Analysis (COA), Delivery Docket/Manifest, Meat Messaging Consignment Report, Meat Transfer Certificate (MTC), Receipt of purchase/Tax	

			Invoice Value Added production management system	
Delivery Docket/Manifest number	This is a unique number allocated to the docket for identification purposes.	Yes	Delivery Docket/Manifest, Value Added production management system	
Export Health Certificate Number	A unique number allocated to the health certificate issued for the export consignment for traceability purposes.	Yes	Export Health Certificate, Meat Messaging Consignment Report, Value Added production management system	For more information visit the Department of Agriculture, Water and the Environment website.
Export Permit Number	A unique permit number is allocated for the export consignment following submission of a correct and validated Request For Permit (RFP) which is then approved by the Secretary.	Yes	Export Permit, Value Added production management system	For more information visit the Department of Agriculture, Water and the Environment website.
From Establishment number	A number issued by Federal and State Authorities to identify the originating site from which meat or meat products were distributed to domestic or export markets. For transfer certificates, the Establishment numbers for both the dispatching and receiving establishments are recorded.	Yes	Carton label, Certificate of Analysis (COA), Delivery Docket/Manifest, Export Health Certificate, Meat Messaging Consignment Report, Meat Transfer Certificate (MTC), SSCC/Pallet label, Value Added production management system	
Global Trade Item Number (GTIN)	Encoded in the GS1 barcode, the GTIN is a globally unique 14-digit number used to identify trade items, products, or services.	Yes	Carton label, Meat Messaging Consignment Report, SSCC/Pallet label, Value Added production management system	For more information visit the GS1 website.
GTIN of Contained Trade Items	Encoded in the GS1 barcode, the GTIN of the contained trade items is a globally unique 14-digit number used to identify trade items, products, or services in the logistic unit.	Yes	SSCC/Pallet label, Value Added production management system	For more information visit the GS1 website.
Movement date	The date on which livestock or other products (e.g., feed or meat products) were transported between PICs/establishments.	Yes	Bill of lading/Air Waybill, Certificate of Analysis (COA), Delivery Docket/Manifest, Export Health Certificate, Meat Transfer Certificate (MTC), Value Added	

			production management system	
MSA Licence Number	Any establishment consigning, supplying, or identifying MSA Certified Product must be registered and have a unique MSA Licence Number.	Yes	Receipt of purchase/Tax Invoice, Value Added production management system	For more information on MSA visit the MLA website.
Net Weight (Kilograms)	Usually encoded in the GS1 barcode, the Net Weight is a variable measure of the trade item e.g., carton, pallet or shipment recorded in kilograms.	Yes	Bill of lading/Air Waybill, Carton label, Export Health Certificate, Meat Messaging Consignment Report, SSCC/Pallet label, Value Added production management system	For more information visit the GS1 website.
Official mark	Any stamp, seal, label, or mark that is declared by the regulations to be an official mark. An official mark signifies that the product has been inspected by and approved as safe for human consumption by an Authorised Officer.	Yes	Carton label, SSCC/Pallet label, Value Added production management system	
Order date	This is the date on which the purchase order or contract was raised by the buyer.	Yes	Delivery Docket/Manifest, Value Added production management system	
Packaging Date	Encoded in the GS1 barcode, the Packaging Date is the date on which the item was packaged and is recorded in the format year, month, day (YYMMDD).	Yes	Carton label, Certificate of Analysis (COA), SSCC/Pallet label, Value Added production management system	For more information visit the GS1 website.
Packaging Date Range	This includes the oldest and newest packaging dates for the logistic unit.	Yes	SSCC/Pallet label, Value Added production management system	For more information visit the GS1 website.
Pallet Serial Shipping Container Code (SSCC)	Encoded in the GS1 barcode, this is a unique number which identifies the individual logistic unit i.e., pallet that is assigned by the establishment constructing the unit. The SSCC remains the same for the life of the logistic unit.	Yes	Meat Messaging Consignment Report, Meat Transfer Certificate (MTC), SSCC/Pallet label, Value Added production management system	For more information visit the GS1 website.
Production Date (YYMMDD)	Encoded in the GS1 barcode, this is the 'kill' or slaughter' date of the product and is recorded in the format year, month, day (YYMMDD).	Yes	Meat Transfer Certificate (MTC), Value Added production management system	For more information visit the GS1 website.
Recipient Australian Business Number (ABN)	This is an 11-digit registration number, issued by the Australian Tax Office, used to identify businesses.	Yes	Receipt of purchase/Tax Invoice, Value Added production management system	For more information visit the ATO website.
Seal Serial Number	This is a unique serial number printed on any tamper-evident seal issued by the Department.	Yes	Bill of lading/Air Waybill, Meat Transfer Certificate (MTC), Official seal, Value Added production management system	For more information visit the Australian Government

				Federal Register of Legislation.
Seller/Supplier Australian Business Number (ABN)	This is an 11-digit registration number, issued by the Australian Tax Office, used to identify businesses.	Yes	Receipt of purchase/Tax Invoice, Value Added production management system	For more information visit the ATO website.
Serial Number	Encoded in the GS1 barcode, this is a code, numeric or alphanumeric, assigned to an individual instance of an item for its lifetime.	Yes	Carton label, Value Added production management system	For more information visit the GS1 website.
Shipping Mark	Also known as a port mark, this is a code comprising of three letters representing the foreign establishment number and the last nine digits of the consignment SSCC.	Yes	Bill of lading/Air Waybill, Certificate of Analysis (COA), Delivery Docket/Manifest, Export Health Certificate, Meat Messaging Consignment Report, SSCC/Pallet label Value Added production management system	
To Establishment number	A number issued by Federal and State Authorities to identify the originating site from which meat or meat products were distributed to domestic or export markets. For transfer certificates, the Establishment numbers for both the dispatching and receiving establishments are recorded.	Yes	Meat Transfer Certificate (MTC), Value Added production management system	
Trade description	This is a collective set of words that says what the product is and may include information such as species, net weight of product, name and address of establishments, category ciphers, market endorsements, MSA eating quality etc.	Yes	Carton label, Delivery Docket/Manifest, Export Health Certificate, Meat Messaging Consignment Report, Meat Transfer Certificate (MTC), SSCC/Pallet label, Value Added production management system	
Transfer Certificate number	A unique certificate number issued for traceability purposes.	Yes	Meat Messaging Consignment Report, Meat Transfer Certificate (MTC), Value Added production management system	
Transport registration number	The registration number of the vehicle in which the animals or product were transported. For shipments of product this will be a shipping container number.	Yes	Bill of lading/Air Waybill, Delivery Docket/Manifest, Export Health Certificate, Meat Messaging Consignment Report, Meat Transfer Certificate (MTC), Value Added production management system	

5.2.3.2.5 Regulatory and Industry Programs

- Meat Standards Australia (MSA)
- AUS-MEAT
- Australian Meat Industry Council (AMIC)
- Department of Agriculture
- Meat Messaging
- State food authority
- Other data sources

5.2.3.2.6 Supply Chain Node Traceability

For Value Added operations the ability to trace product forward and track product backwards is defined by food safety regulations. In practice, this means that any prepared meat retail-ready or food service products are managed as a batch (with unique serialised carton labels or retail-ready product labels) with the inputs to the batch being all the carcass or carton identification units (carcass tickets/carton labels) that went into the batch. Should a recall occur related to any of the input material the whole value-added batch(s) would be recalled.

Tracing a single meat retail-ready or food service product (e.g., a portion prepared steak) back to a single animal or source property is operationally impractical. The example below shows the complexity of such a trace back.

Retail ready product traceability example:

1. The volume of retail-ready or food service product made in a batch would likely be in the order of 1 000 kg (50 x 20 kg primal cut cartons) which equates to 100 x 10 kg of finished retail-ready/food service cartons or approximately 2 000 x 500 g portioned steak packs. With each pack containing four steaks, this equates to 8 000 steaks. This is managed as a production batch and as such, any one steak in any carton may have come from any of the 50 x 20 kg primal cut cartons.
2. The cartons from which this retail-ready product (50 x 20 kg cartons) was produced may have been comprised of 1 000 kg of lamb leg primal cut cartons. These cartons might typically be sourced from 2 processing establishments and over 3 production days for each processing establishment, this is a total of 6 plant kill days.
3. The average weight of the lamb legs in each carton is 2.5 kg. This means that each carton has 8 lamb legs. With each carcass having 2 lamb legs, the 50 cartons may have been produced from 200 head of sheep.
4. Each processing plant might kill 5 000 head per day, and these might come from an average of 20 source properties. The traceability of cartoned boning room product is limited to the carcasses that have entered the boning room for the production run of cartons that are created. This means that the primal cut e.g., lamb leg in any carton may have come from any of the 5 000 carcasses for that boning run production day.
5. As the lamb leg primal cut cartons came from a total of 6 plant kill day combinations, this equates to any primal cut coming from any one of a possible 30 000 head of sheep or 120 possible source properties.

In summary, for this example, any individual 500 g portion cut steak pack may have come from any one or combination of 30 000 head of sheep from any one of 120 source properties. It is possible in some very small scale and very high value commercial operations to manage single body boning and tracking the cuts to retail-ready packaging. However, this would represent less than a fraction of a percent of the total meat industry production volume.

5.2.3.2.7 Data flow diagrams

Table 69. Data flow diagrams for the inputs and outputs of a small stock value-added system.

Direction	Description
Input	Carcase chiller to Value adding
Input	Carton chiller/ freezer to Value adding
Output	Value added to Supermarket
Output	Value added to Butcher
Output	Value added to Food services
Output	Value added to Third party cold store
Output	Value added to export

5.2.3.2.7.1 Carcase chiller to Value adding

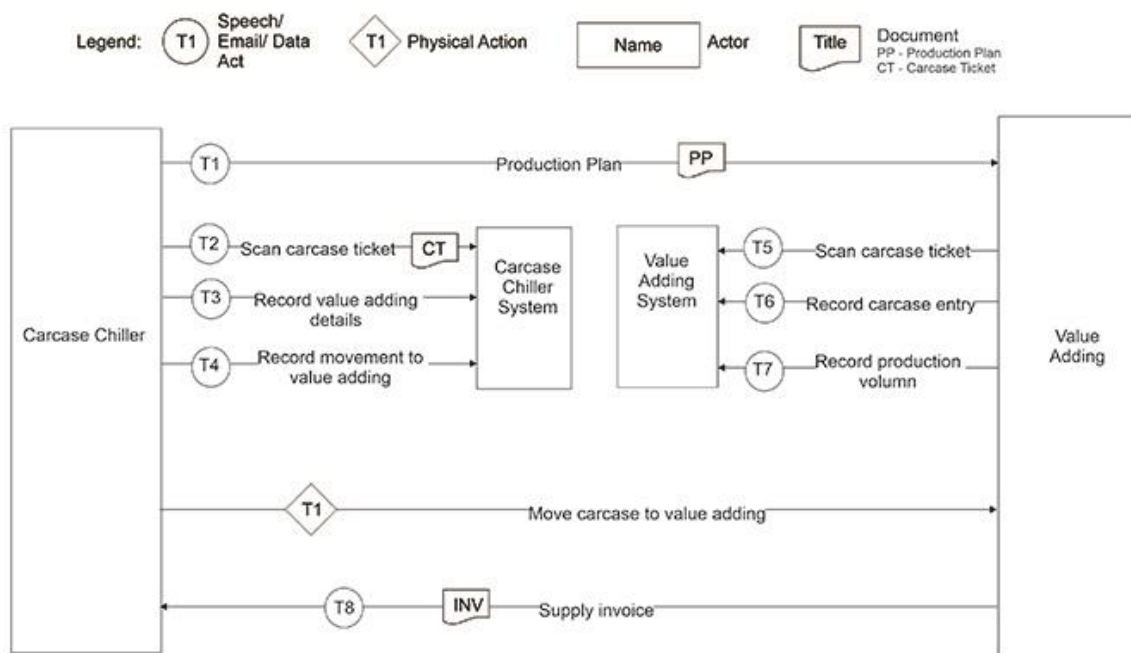

Carcase Chiller to Value Adding

Figure 80. Data or information flow from the carcase chiller to value adding in the small stock supply chain.

5.2.3.2.7.2 Carton chiller/ freezer to Value adding

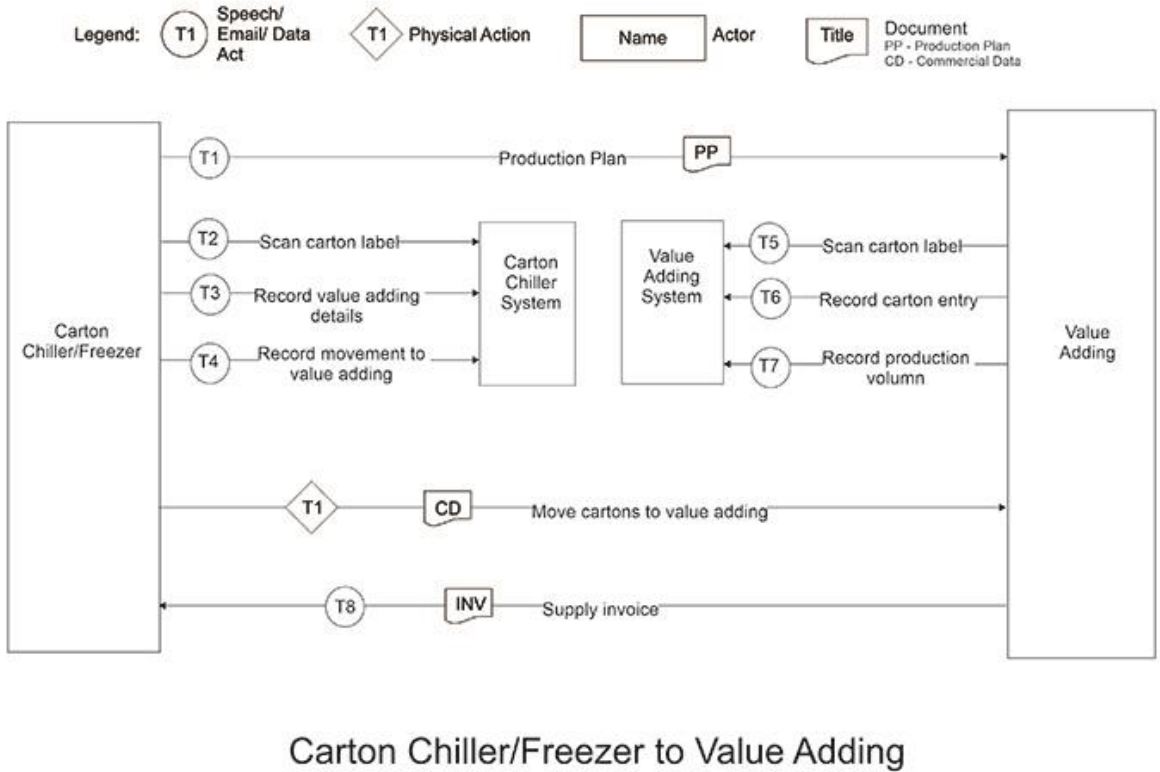

Figure 81. Data or information flows from the carton chiller/freezer to value adding in the small stock supply chain.

5.2.3.2.7.3 Value added to Supermarket

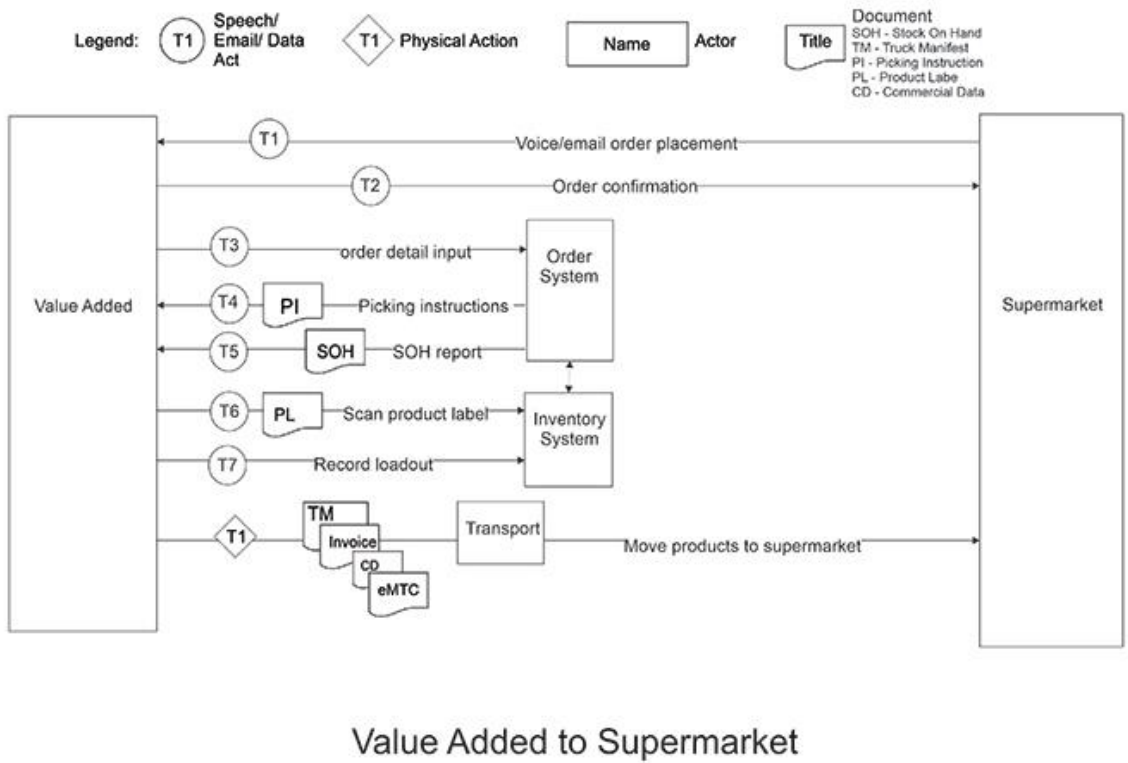

Figure 82. Data or information flows from the value added to supermarket in the small stock supply chain.

5.2.3.2.7.4 Value added to Butcher

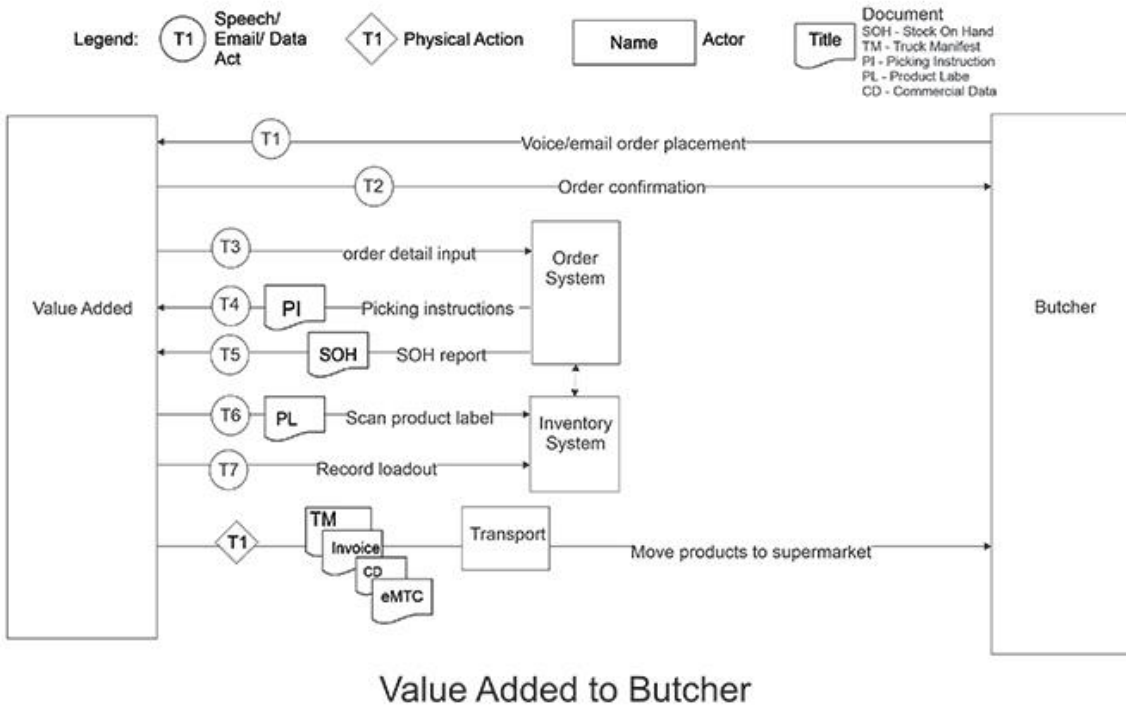

Figure 83. Data or information flows from the value added to butcher in the small stock supply chain.

5.2.3.2.7.5 Value added to Food services

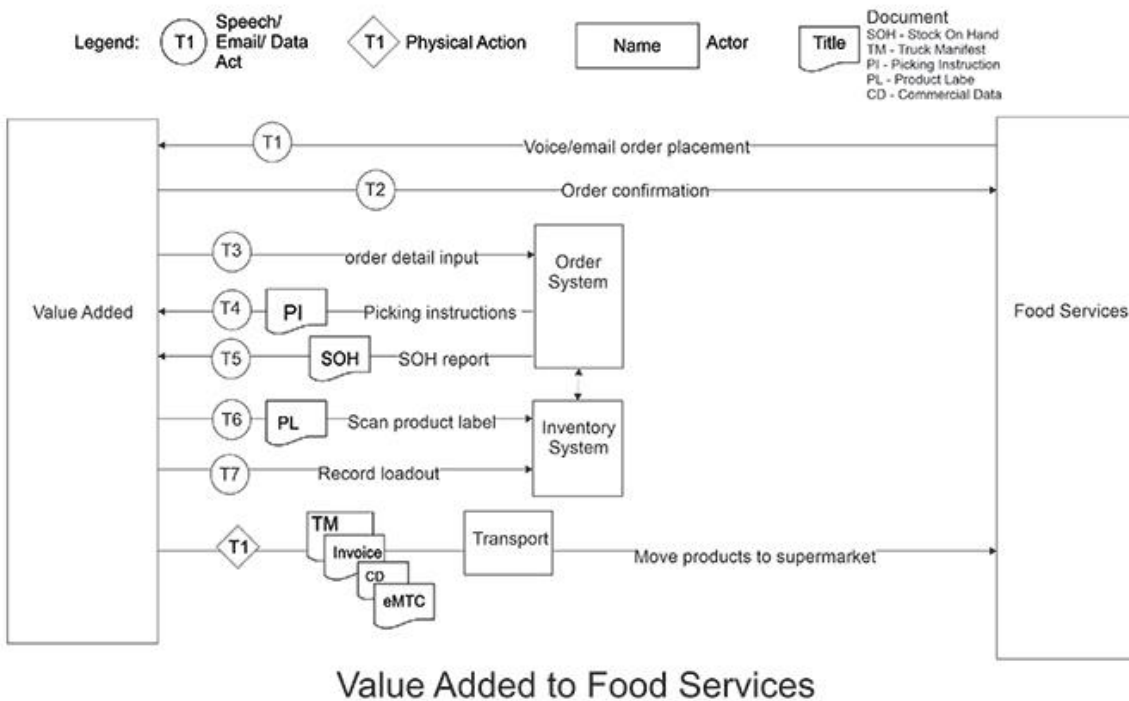
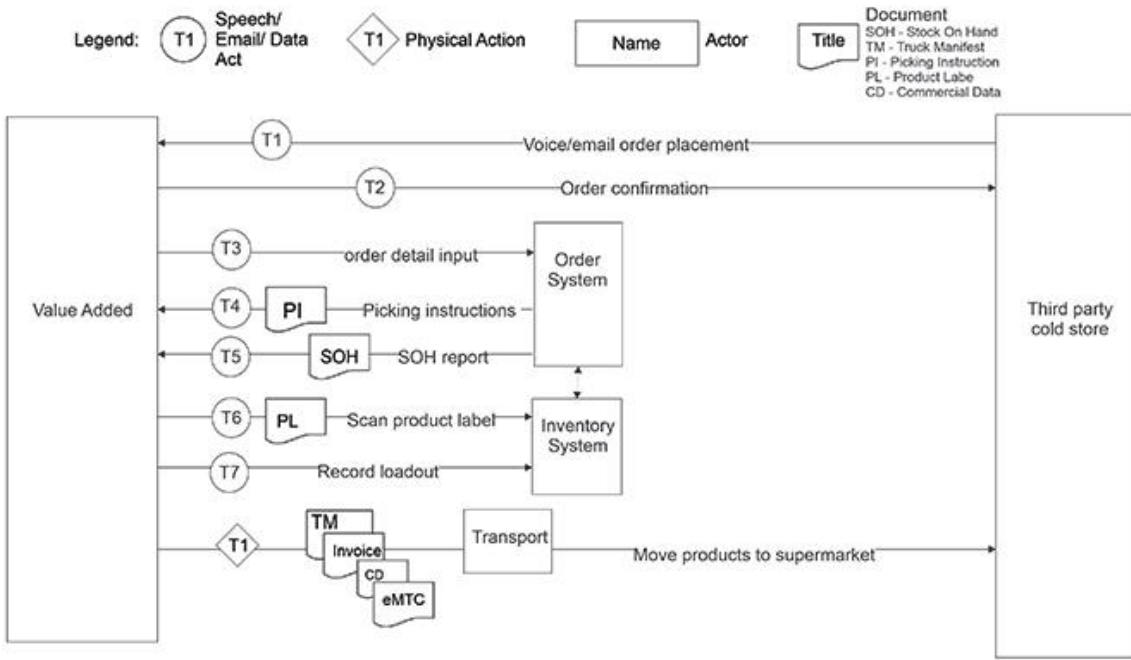

Figure 84. Data or information flows from the value added to food services in the small stock supply chain.

5.2.3.2.7.6 Value added to Third party cold store



Value Added to Third party cold store

Figure 85. Data or information flows from the value added to third party cold store in the small stock supply chain.

5.2.3.2.7.7 Value added to export

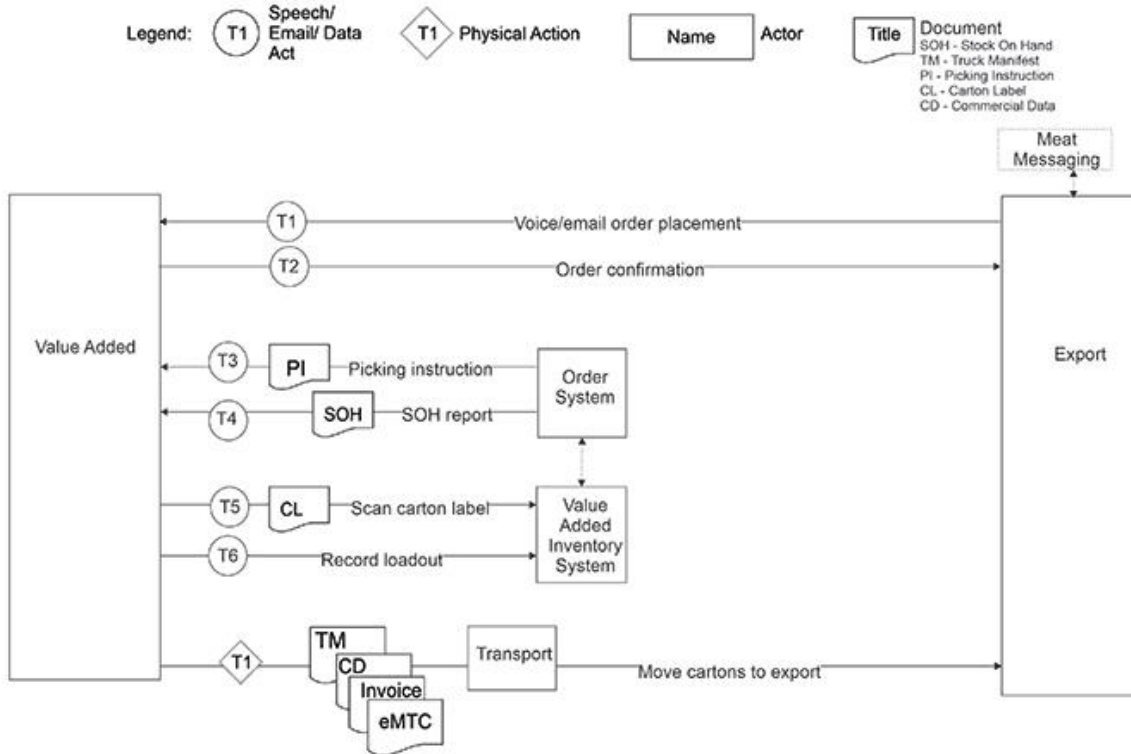

Value Added to Export

Figure 86. Data or information flows the value added to export in the small stock supply chain.

5.2.3.3 Third party cold store

Storing chilled carcasses or carcase products (e.g., cartons) typically provides a stock buffer between production and dispatch of product intended for domestic or export markets. A third-party cold storage system is an establishment, separate from a processing establishment, which performs activities the same as that for a cold storage facility integrated into a processing plant. However, product from multiple suppliers may be stored and/combined for dispatch. A cold storage facility involves refrigerated chambers that can chill or freeze any perishable product for a period of time before dispatch. During this process, the ageing of meat also occurs, progressively increasing tenderness and flavour. Storage rooms must take into account the storage requirements for different products as well as rules for loading, maintenance and hygiene of storage equipment.

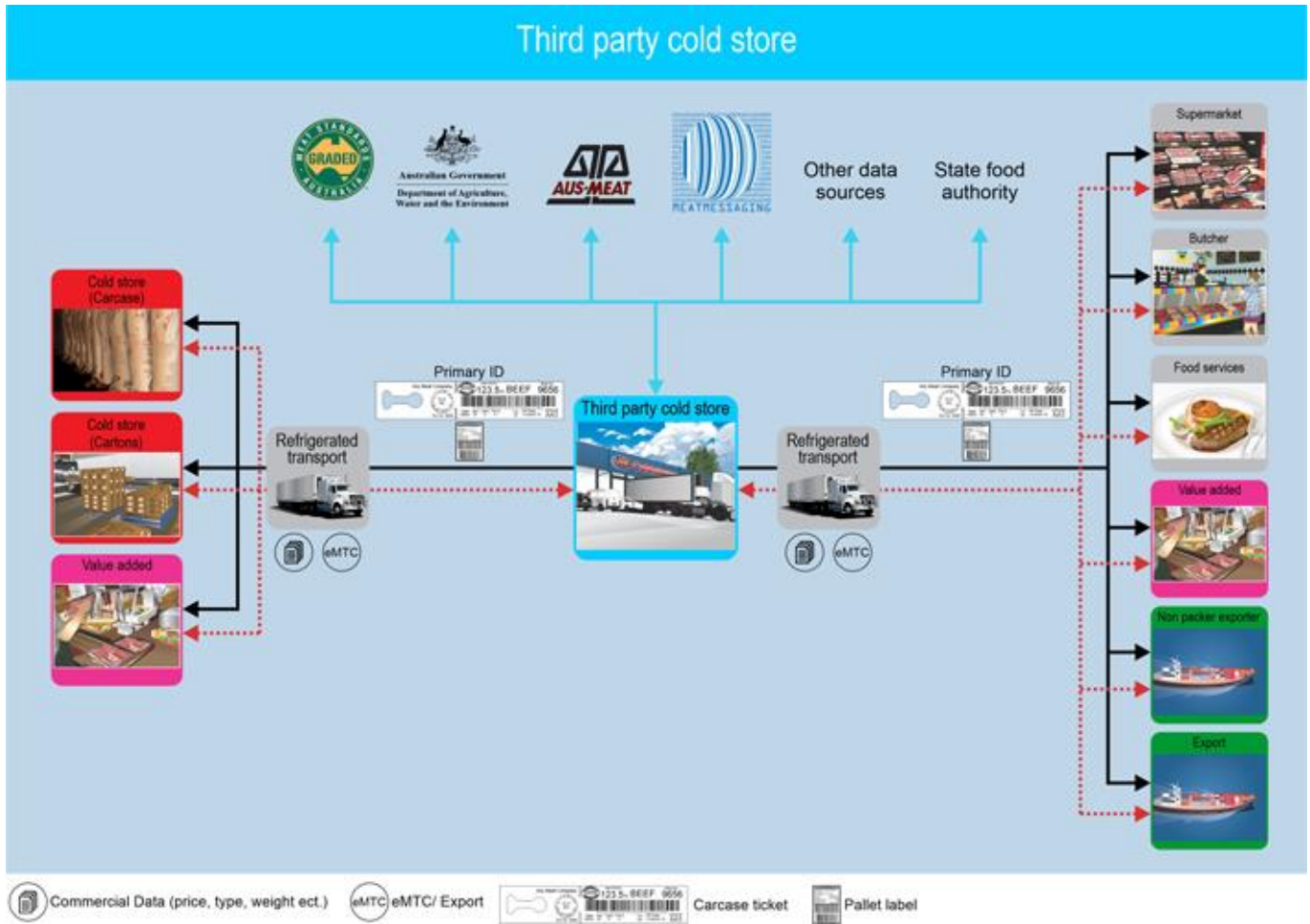

Figure 87. Inputs and outputs of the small stock supply chain third party cold store sector.

5.2.3.3.1 Physical Inputs including Critical Tracking Events (CTEs)

Cold stores generally offer their clients a range of services involving stock rotation, logistics, maintenance, and systems of identification. Product moved into cold stores ranges from carcasses to pallets of product. These are accompanied by documentation such as Meat Transfer Certificates and Delivery Dockets.

Critical Tracking Events (CTEs) are defined as those events which include the growing, receiving, transforming, creating, and shipping of food products. Such events are critical to the traceability of product throughout the supply chain.

The CTEs associated with inputs to the third party cold store system include the receipt of:

- Carcase
- Carton
- Pallet.

Table 70. Physical inputs and associated Critical Tracking Event related documents for a small stock third party cold store system.

Event related to the inputs	Description of the inputs	Critical Tracking Event (CTE) related documents (including electronic)	More details
Carcase	The body of a slaughtered animal after bleeding. Becomes a dressed carcass when hide/skin, head, feet, and offal are removed.	Carcass Ticket, Delivery Docket/Manifest, Meat Transfer Certificate (MTC), MSA Carcass Ticket, Receipt of purchase/Tax Invoice, Third Party Cold Store production management system	
Carton	This is a case, crate, or barrel of product.	Carton label, Delivery Docket/Manifest, Meat Transfer Certificate (MTC), Official seal, Receipt of purchase/Tax Invoice, Third Party Cold Store production management system	
Pallet	A logistic unit which includes a number of cartons or goods items packed together for transport or storage purposes.	Delivery Docket/Manifest, Meat Transfer Certificate (MTC), Receipt of purchase/Tax Invoice, SSCC/Pallet label, Third Party Cold Store production management system	

5.2.3.3.2 Information Inputs including Key Data Elements (KDEs)

Key Data Elements (KDEs) are defined as those elements which are key in identifying and tracing the Critical Tracking Event (CTE). Key Data Elements found on CTE documentation accompanying the movement of product into cold stores ranges from carcass body numbers (found on the Carcass Ticket) to establishment numbers, official marks, and seal serial numbers.

Table 71. Information inputs, Key Data Elements and Critical Tracking Event related documentation for a small stock third party cold store system.

Attributes (including KDEs)	Description of the Attributes (including KDEs)	Is a KDE	Critical Tracking Event (CTE) related documents (including electronic)	More details
Body number	This is a number assigned to each carcass by the processor for identification purposes.	Yes	Carcass Ticket, Third Party Cold Store production management system	
Company/product code	This is an in-house code for the identification of the product in the unit.	Yes	Carton label, Receipt of purchase/Tax Invoice, SSCC/Pallet label, Third Party Cold Store production management system	
Consignment Serial Shipping Container Code (SSCC)	Encoded in the GS1 barcode, this is a unique number which identifies the individual logistic unit i.e., shipment/message that is assigned by	Yes	Meat Transfer Certificate (MTC), SSCC/Pallet label, Third Party Cold Store	For more information visit the GS1 website.

	the establishment constructing the unit. The SSCC remains the same for the life of the logistic unit.		production management system	
Contract number	This is a unique number allocated to the contract by the seller.	Yes	Delivery Docket/Manifest	
Count of Trade Items	Usually encoded in the GS1 barcode, this is the number of trade items e.g., cartons in the logistic unit.	Yes	Delivery Docket/Manifest, SSCC/Pallet label, Third Party Cold Store production management system	For more information visit the GS1 website.
Date	This is the date of signing or of which a record entry or transaction was made.	Yes	Delivery Docket/Manifest, Meat Transfer Certificate (MTC), Receipt of purchase/Tax Invoice, Third Party Cold Store production management system	
Delivery Docket/Manifest number	This is a unique number allocated to the docket for identification purposes.	Yes	Delivery Docket/Manifest, Third Party Cold Store production management system	
From Establishment number	A number issued by Federal and State Authorities to identify the originating site from which meat or meat products were distributed to domestic or export markets. For transfer certificates, the Establishment numbers for both the dispatching and receiving establishments are recorded.	Yes	Carcase Ticket, Carton label, Delivery Docket/Manifest, Meat Transfer Certificate (MTC), SSCC/Pallet label, Third Party Cold Store production management system	
Global Trade Item Number (GTIN)	Encoded in the GS1 barcode, the GTIN is a globally unique 14-digit number used to identify trade items, products, or services.	Yes	Carcase Ticket, Carton label, SSCC/Pallet label, Third Party Cold Store production management system	For more information visit the GS1 website.
GTIN of Contained Trade Items	Encoded in the GS1 barcode, the GTIN of the contained trade items is a globally unique 14-digit number used to identify trade items, products, or services in the logistic unit.	Yes	SSCC/Pallet label, Third Party Cold Store production management system	For more information visit the GS1 website.
Lot number	A lot is a number assigned by the processor to each group of livestock consigned to slaughter and is usually vendor specific.	Yes	Carcase Ticket, Third Party Cold Store production management system	
Movement date	The date on which livestock or other products (e.g., feed or meat products) were transported between PICs/establishments.	Yes	Delivery Docket/Manifest, Meat Transfer Certificate (MTC), Third Party Cold Store production management system	

MSA eating quality group/grade	This identifies carcasses with similar MSA and eating quality grades, these may align with brands packed by the processor for logistic simplicity. Carcasses are grouped for boning according to eating quality grades.	Yes	MSA Carcase Ticket, Third Party Cold Store production management system, Receipt of purchase/Tax Invoice, Third Party Cold Store production management system	For more information on MSA visit the MLA website.
Net Weight (Kilograms)	Usually encoded in the GS1 barcode, the Net Weight is a variable measure of the trade item e.g., carton, pallet or shipment recorded in kilograms.	Yes	Carcase Ticket, Carton label, SSCC/Pallet label, Third Party Cold Store production management system	For more information visit the GS1 website.
Official mark	Any stamp, seal, label, or mark that is declared by the regulations to be an official mark. An official mark signifies that the product has been inspected by and approved as safe for human consumption by an Authorised Officer.	Yes	Carcase Ticket, Carton label, SSCC/Pallet label, Third Party Cold Store production management system	
Order date	This is the date on which the purchase order or contract was raised by the buyer.	Yes	Delivery Docket/Manifest, Third Party Cold Store production management system	
Packaging Date	Encoded in the GS1 barcode, the Packaging Date is the date on which the item was packaged and is recorded in the format year, month, day (YYMMDD).	Yes	Carton label, SSCC/Pallet label, Third Party Cold Store production management system	For more information visit the GS1 website.
Packaging Date Range	This includes the oldest and newest packaging dates for the logistic unit.	Yes	SSCC/Pallet label, Third Party Cold Store production management system	For more information visit the GS1 website.
Pallet Serial Shipping Container Code (SSCC)	Encoded in the GS1 barcode, this is a unique number which identifies the individual logistic unit i.e., pallet that is assigned by the establishment constructing the unit. The SSCC remains the same for the life of the logistic unit.	Yes	Meat Transfer Certificate (MTC), SSCC/Pallet label, Third Party Cold Store production management system	For more information visit the GS1 website.
Production Date (YYMMDD)	Encoded in the GS1 barcode, this is the 'kill' or slaughter' date of the product and is recorded in the format year, month, day (YYMMDD).	Yes	Carcase Ticket, Meat Transfer Certificate (MTC), Third Party Cold Store production management system	For more information visit the GS1 website.
Recipient Australian Business Number (ABN)	This is an 11-digit registration number, issued by the Australian Tax Office, used to identify businesses.	Yes	Receipt of purchase/Tax Invoice, Third Party Cold Store production management system	For more information visit the ATO website.
Seal Serial Number	This is a unique serial number printed on any tamper-evident seal issued by the Department.	Yes	Meat Transfer Certificate (MTC), Official seal, Third Party Cold Store production management system	For more information visit the Australian Government Federal Register of Legislation.

Seller/Supplier Australian Business Number (ABN)	This is an 11-digit registration number, issued by the Australian Tax Office, used to identify businesses.	Yes	Receipt of purchase/Tax Invoice, Third Party Cold Store production management system	For more information visit the ATO website.
Serial Number	Encoded in the GS1 barcode, this is a code, numeric or alphanumeric, assigned to an individual instance of an item for its lifetime.	Yes	Carcase Ticket, Carton label, Third Party Cold Store production management system	For more information visit the GS1 website.
Shipping Mark	Also known as a port mark, this is a code comprising of three letters representing the foreign establishment number and the last nine digits of the consignment SSCC.	Yes	Delivery Docket/Manifest, SSCC/Pallet label, Third Party Cold Store production management system	
To Establishment number	A number issued by Federal and State Authorities to identify the originating site from which meat or meat products were distributed to domestic or export markets. For transfer certificates, the Establishment numbers for both the dispatching and receiving establishments are recorded.	Yes	Meat Transfer Certificate (MTC), Third Party Cold Store production management system	
Trade description	This is a collective set of words that says what the product is and may include information such as species, net weight of product, name and address of establishments, category ciphers, market endorsements, MSA eating quality etc.	Yes	Carcase Ticket, Carton label, Delivery Docket/Manifest, Meat Transfer Certificate (MTC), SSCC/Pallet label, Third Party Cold Store production management system	
Transfer Certificate number	A unique certificate number issued for traceability purposes.	Yes	Meat Transfer Certificate (MTC), Third Party Cold Store production management system	
Transport registration number	The registration number of the vehicle in which the animals or product were transported. For shipments of product this will be a shipping container number.	Yes	Delivery Docket/Manifest, Meat Transfer Certificate (MTC), Third Party Cold Store production management system	

5.2.3.3.3 Physical Outputs including Critical Tracking Events (CTEs)

Product exiting cold stores and transferred along the supply chain may include carcasses to shipping containers for export product. Documentation required here includes that for both domestic and export product such as a Delivery Docket/Manifest, MTC, Bill of lading/Air Waybill, Export Permit and Export Health Certificate.

Critical Tracking Events (CTEs) are defined as those events which include the growing, receiving, transforming, creating, and shipping of food products. Such events are critical to the traceability of product throughout the supply chain.

The CTEs associated with the outputs of the third party cold store system include the movement of:

- Carcase
- Carton
- Pallet
- Container System Unit

off the property, premises or supply chain sector.

Table 72. Physical outputs and associated Critical Tracking Event related documents for a small stock third party cold store system.

Event related to the inputs	Description of the inputs	Critical Tracking Event (CTE) related documents (including electronic)	More details
Carcase	The body of a slaughtered animal after bleeding. Becomes a dressed carcase when hide/skin, head, feet, and offal are removed.	Carcase Ticket, Delivery Docket/Manifest, Meat Transfer Certificate (MTC), MSA Carcase Ticket, Receipt of purchase/Tax Invoice, Third Party Cold Store production management system	
Carton	This is a case, crate, or barrel of product.	Carton label, Delivery Docket/Manifest, Meat Transfer Certificate (MTC), Official seal, Receipt of purchase/Tax Invoice, Third Party Cold Store production management system	
Pallet	A logistic unit which includes a number of cartons or goods items packed together for transport or storage purposes.	Bill of lading/Air Waybill, Certificate of Analysis (COA), Delivery Docket/Manifest, Export Health Certificate, Export Permit, Receipt of purchase/Tax Invoice, SSCC/Pallet label, Third Party Cold Store production management system, Meat Transfer Certificate (MTC)	
Container System Unit	A container designed for use as a unit of cargo handling equipment in the transport of goods by aircraft or ship.	Bill of lading/Air Waybill, Certificate of Analysis (COA), Delivery Docket/Manifest, Export Health Certificate, Export Permit, Meat Messaging Consignment Report, Meat Transfer Certificate (MTC), Official seal, Third Party Cold Store production management system	

5.2.3.3.4 Information Outputs including Key Data Elements (KDEs)

Key Data Elements (KDEs) are defined as those elements which are key in identifying and tracing the Critical Tracking Event (CTE). Key Data Elements from cold store CTE related documentation will be stored in the production management system. Such information may include, but not be limited to, GS1 barcode application identifiers, movement dates, product net weight, seal serial numbers and transfer certificate numbers.

Table 73. Information outputs, Key Data Elements and Critical Tracking Event related documentation for a small stock third party cold store system.

Attributes (including KDEs)	Description of the Attributes (including KDEs)	Is a KDE	Critical Tracking Event (CTE) related documents (including electronic)	More details
Analysis Date	This is the date on which a product sample was analysed.	Yes	Certificate of Analysis (COA), Third Party Cold Store production management system	

Bill of lading/Air Waybill document number	A unique document number issued for traceability purposes.	Yes	Bill of lading/Air Waybill, Certificate of Analysis (COA), Third Party Cold Store production management system	
Body number	This is a number assigned to each carcase by the processor for identification purposes.	Yes	Carcase Ticket, Third Party Cold Store production management system	
Certificate of Analysis number	A unique certificate number issued for traceability purposes.	Yes	Certificate of Analysis (COA), Third Party Cold Store production management system	
COA test lot identifier	This is a unique identifier allocated to all cartons, pallets, and shipping containers for which an analysis sample represents.	Yes	Certificate of Analysis (COA), Third Party Cold Store production management system	
Company/product code	This is an in-house code for the identification of the product in the unit.	Yes	Bill of lading/Air Waybill, Carton label, Certificate of Analysis (COA), Receipt of purchase/Tax Invoice, SSCC/Pallet label, Third Party Cold Store production management system	
Consignment Serial Shipping Container Code (SSCC)	Encoded in the GS1 barcode, this is a unique number which identifies the individual logistic unit i.e., shipment/message that is assigned by the establishment constructing the unit. The SSCC remains the same for the life of the logistic unit.	Yes	Bill of lading/Air Waybill, Meat Messaging Consignment Report, Meat Transfer Certificate (MTC), SSCC/Pallet label, Third Party Cold Store production management system	For more information visit the GS1 website.
Contract number	This is a unique number allocated to the contract by the seller.	Yes	Delivery Docket/Manifest, Third Party Cold Store production management system	
Count of Pallets	This is the number of pallets in the logistic unit e.g., container system unit.	Yes	Meat Messaging Consignment Report, Third Party Cold Store production management system	
Count of Trade Items	Usually encoded in the GS1 barcode, this is the number of trade items e.g., cartons in the logistic unit.	Yes	Bill of lading/Air Waybill, Delivery Docket/Manifest, Meat Messaging Consignment Report, SSCC/Pallet label, Third Party Cold Store production management system	For more information visit the GS1 website.
Date	This is the date of signing or of which a record entry or transaction was made.	Yes	Bill of lading/Air Waybill, Certificate of Analysis (COA), Delivery Docket/Manifest, Meat Messaging Consignment Report, Meat Transfer Certificate (MTC), Receipt of purchase/Tax Invoice, Third	

			Party Cold Store production management system	
Delivery Docket/Manifest number	This is a unique number allocated to the docket for identification purposes.	Yes	Delivery Docket/Manifest, Third Party Cold Store production management system	
Export Health Certificate Number	A unique number allocated to the health certificate issued for the export consignment for traceability purposes.	Yes	Export Health Certificate, Meat Messaging Consignment Report, Third Party Cold Store production management system	For more information visit the Department of Agriculture, Water and the Environment website.
Export Permit Number	A unique permit number is allocated for the export consignment following submission of a correct and validated Request For Permit (RFP) which is then approved by the Secretary.	Yes	Export Permit, Third Party Cold Store production management system	For more information visit the Department of Agriculture, Water and the Environment website.
From Establishment number	A number issued by Federal and State Authorities to identify the originating site from which meat or meat products were distributed to domestic or export markets. For transfer certificates, the Establishment numbers for both the dispatching and receiving establishments are recorded.	Yes	Carcase Ticket, Carton label, Certificate of Analysis (COA), Delivery Docket/Manifest, Export Health Certificate, Meat Messaging Consignment Report, Meat Transfer Certificate (MTC), SSCC/Pallet label, Third Party Cold Store production management system	
Global Trade Item Number (GTIN)	Encoded in the GS1 barcode, the GTIN is a globally unique 14-digit number used to identify trade items, products, or services.	Yes	Carcase Ticket, Carton label, Meat Messaging Consignment Report, SSCC/Pallet label, Third Party Cold Store production management system	For more information visit the GS1 website.
GTIN of Contained Trade Items	Encoded in the GS1 barcode, the GTIN of the contained trade items is a globally unique 14-digit number used to identify trade items, products, or services in the logistic unit.	Yes	SSCC/Pallet label, Third Party Cold Store production management system	For more information visit the GS1 website.
Lot number	A lot is a number assigned by the processor to each group of livestock consigned to slaughter and is usually vendor specific.	Yes	Carcase Ticket, Third Party Cold Store production management system	
Movement date	The date on which livestock or other products (e.g., feed or meat products) were transported between PICs/establishments.	Yes	Bill of lading/Air Waybill, Certificate of Analysis (COA), Delivery Docket/Manifest, Export Health Certificate, Meat Transfer Certificate (MTC), Third Party Cold Store	

			production management system	
MSA eating quality group/grade	This identifies carcasses with similar MSA and eating quality grades, these may align with brands packed by the processor for logistic simplicity. Carcasses are grouped for boning according to eating quality grades.	Yes	MSA Carcase Ticket, Third Party Cold Store production management system	For more information on MSA visit the MLA website.
MSA Licence Number	Any establishment consigning, supplying, or identifying MSA Certified Product must be registered and have a unique MSA Licence Number.	Yes	Receipt of purchase/Tax Invoice, Third Party Cold Store production management system	For more information on MSA visit the MLA website.
Net Weight (Kilograms)	Usually encoded in the GS1 barcode, the Net Weight is a variable measure of the trade item e.g., carton, pallet or shipment recorded in kilograms.	Yes	Bill of lading/Air Waybill, Carcase Ticket, Carton label, Export Health Certificate, Meat Messaging Consignment Report, SSCC/Pallet label, Third Party Cold Store production management system	For more information visit the GS1 website.
Official mark	Any stamp, seal, label, or mark that is declared by the regulations to be an official mark. An official mark signifies that the product has been inspected by and approved as safe for human consumption by an Authorised Officer.	Yes	Carcase Ticket, Carton label, SSCC/Pallet label, Third Party Cold Store production management system	
Order date	This is the date on which the purchase order or contract was raised by the buyer.	Yes	Delivery Docket/Manifest, Third Party Cold Store production management system	
Packaging Date	Encoded in the GS1 barcode, the Packaging Date is the date on which the item was packaged and is recorded in the format year, month, day (YYMMDD).	Yes	Carton label, Certificate of Analysis (COA), SSCC/Pallet label, Third Party Cold Store production management system	For more information visit the GS1 website.
Packaging Date Range	This includes the oldest and newest packaging dates for the logistic unit.	Yes	SSCC/Pallet label, Third Party Cold Store production management system	For more information visit the GS1 website.
Pallet Serial Shipping Container Code (SSCC)	Encoded in the GS1 barcode, this is a unique number which identifies the individual logistic unit i.e., pallet that is assigned by the establishment constructing the unit. The SSCC remains the same for the life of the logistic unit.	Yes	Meat Messaging Consignment Report, Meat Transfer Certificate (MTC), SSCC/Pallet label, Third Party Cold Store production management system	For more information visit the GS1 website.
Production Date (YYMMDD)	Encoded in the GS1 barcode, this is the 'kill' or slaughter' date of the product and is recorded in the format year, month, day (YYMMDD).	Yes	Carcase Ticket, Meat Transfer Certificate (MTC), Third Party Cold Store production management system	For more information visit the GS1 website.

Recipient Australian Business Number (ABN)	This is an 11-digit registration number, issued by the Australian Tax Office, used to identify businesses.	Yes	Receipt of purchase/Tax Invoice, Third Party Cold Store production management system	For more information visit the ATO website.
Seal Serial Number	This is a unique serial number printed on any tamper-evident seal issued by the Department.	Yes	Bill of lading/Air Waybill, Meat Transfer Certificate (MTC), Official seal, Third Party Cold Store production management system	For more information visit the Australian Government Federal Register of Legislation.
Seller/Supplier Australian Business Number (ABN)	This is an 11-digit registration number, issued by the Australian Tax Office, used to identify businesses.	Yes	Receipt of purchase/Tax Invoice, Third Party Cold Store production management system	For more information visit the ATO website.
Serial Number	Encoded in the GS1 barcode, this is a code, numeric or alphanumeric, assigned to an individual instance of an item for its lifetime.	Yes	Carcase Ticket, Carton label, Third Party Cold Store production management system	For more information visit the GS1 website.
Shipping Mark	Also known as a port mark, this is a code comprising of three letters representing the foreign establishment number and the last nine digits of the consignment SSCC.	Yes	Bill of lading/Air Waybill, Certificate of Analysis (COA), Delivery Docket/Manifest, Export Health Certificate, Meat Messaging Consignment Report, SSCC/Pallet label, Third Party Cold Store production management system	
To Establishment number	A number issued by Federal and State Authorities to identify the originating site from which meat or meat products were distributed to domestic or export markets. For transfer certificates, the Establishment numbers for both the dispatching and receiving establishments are recorded.	Yes	Meat Transfer Certificate (MTC), Third Party Cold Store production management system	
Trade description	This is a collective set of words that says what the product is and may include information such as species, net weight of product, name and address of establishments, category ciphers, market endorsements, MSA eating quality etc.	Yes	Carcase Ticket, Carton label, Delivery Docket/Manifest, Export Health Certificate, Meat Messaging Consignment Report, Meat Transfer Certificate (MTC), SSCC/Pallet label, Third Party Cold Store production management system	
Transfer Certificate number	A unique certificate number issued for traceability purposes.	Yes	Meat Messaging Consignment Report, Meat Transfer Certificate (MTC), Third Party Cold Store production management system	
Transport registration number	The registration number of the vehicle in which the animals or product were transported. For	Yes	Bill of lading/Air Waybill, Delivery Docket/Manifest, Export Health Certificate, Meat	

	shipments of product this will be a shipping container number.	Messaging Consignment Report, Meat Transfer Certificate (MTC), Third Party Cold Store production management system	
--	--	--	--

5.2.3.3.5 Regulatory and Industry Programs

- Meat Standards Australia (MSA)
- AUS-MEAT
- Australian Meat Industry Council (AMIC)
- Department of Agriculture
- Meat Messaging
- State food authority
- Other data sources

5.2.3.3.6 Supply Chain Node Traceability

The traceability of third-party cold store product back to the live animal (depending on the NLIS tag type), or consignment group and property of origin is dependent on the form in which product enters the storage premises. This may include whole carcass, cartoned or palletised form.

Traceability of whole carcasses back to the live animal, or consignment group is possible and can be done by the processing establishment where the animal was slaughtered. Here, carcasses are issued a carcass ticket which correlates to the PIC number or live animal identifier and contains key information, including GS1 meat industry barcode, body number, processing establishment number and production date or 'kill date'. This information is uploaded to the NLIS Database, by the processor, under the processing establishments Property Identification Code (PIC). Thus, whole carcasses (identified with a unique serialised carcass ticket) within a processing facility, chiller, cold store, or that are loaded for export or transport to other premises (e.g., retail) are fully traceable back to the individual live animal, or the consignment group and property of origin.

Traceability for cartoned and palletised product is limited to the carcasses that have entered the boning room for the production run of cartons that are created. For example, 200 carcasses individually identified with unique carcass tickets enter the boning room for a specific boning run. These carcass tickets are linked to the specific boning run. From these 200 cartons of primal cuts and 200 cartons of trim and other highly mixed products are created. While all cartons are identified with unique serialised carton labels, including a GS1 meat industry barcode, linked to the boning run (and may be packaged into pallets containing unique serialised pallet labels including a GS1 SSCC barcode), it is not readily possible to identify which carcasses are in which cartons as the cartons will contain meat products from different carcasses. If the carcasses were sourced from several different properties, the resulting carton can only be traced to a number of possible carcasses and source properties. In logistical systems such as transport and cold stores, cartons are typically processed by pallets with only the pallet label being scanned. Therefore, traceability through logistics is often at the pallet level.

5.2.3.3.7 Data flow diagrams

Table 74. Data flow diagrams for the inputs and outputs of a small stock third party cold store system.

Direction	Description
Output	Third Party Cold Store to Supermarket
Input	Third Party Cold Store to Butcher
Output	Third Party Cold Store to Food Services
Output	Third Party Cold Store to Value Added
Output	Third Party Cold Store to Non-Packer Exporter
Output	Third Party Cold Store to Export

5.2.3.3.7.1 Third Party Cold Store to Supermarket

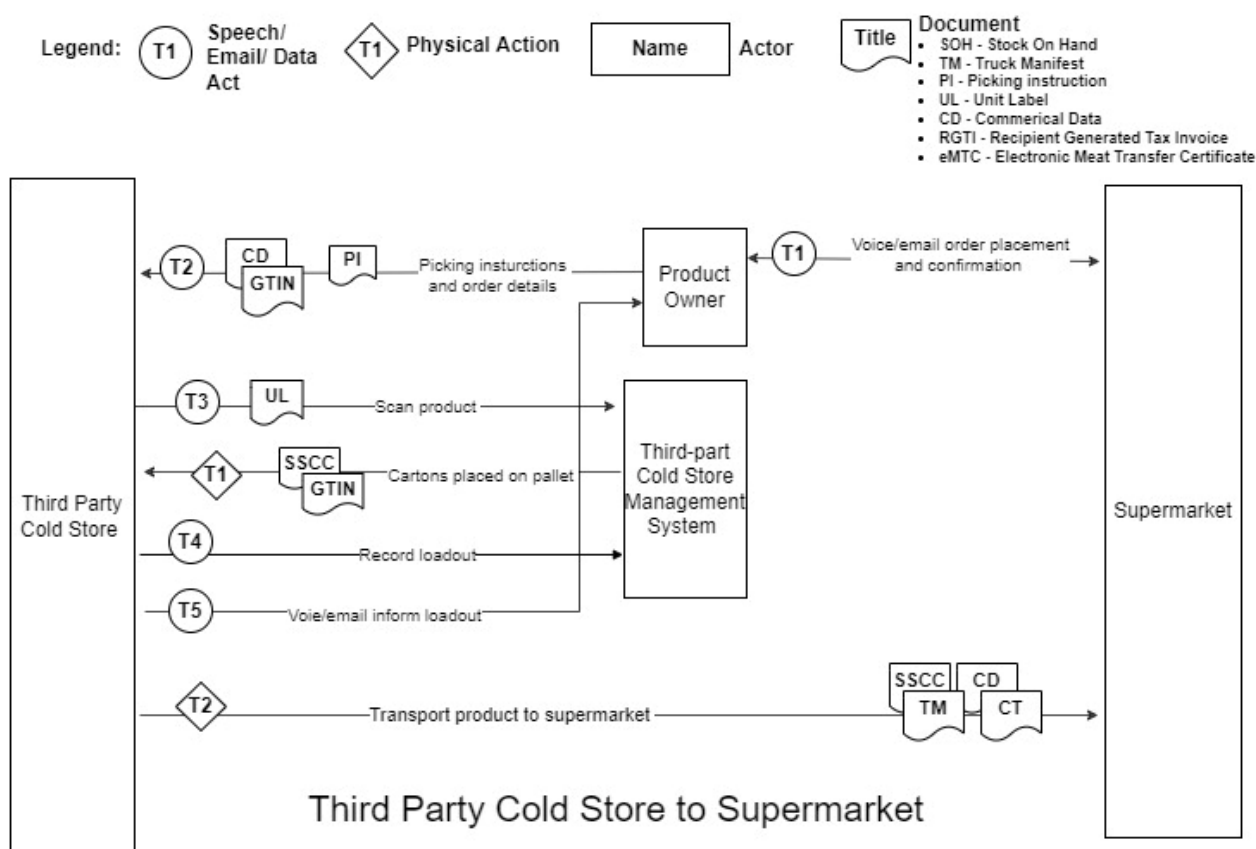

Figure 88. Data or information flows from the third-party cold store to supermarket in the small stock supply chain.

5.2.3.3.7.2 Third Party Cold Store to Butcher

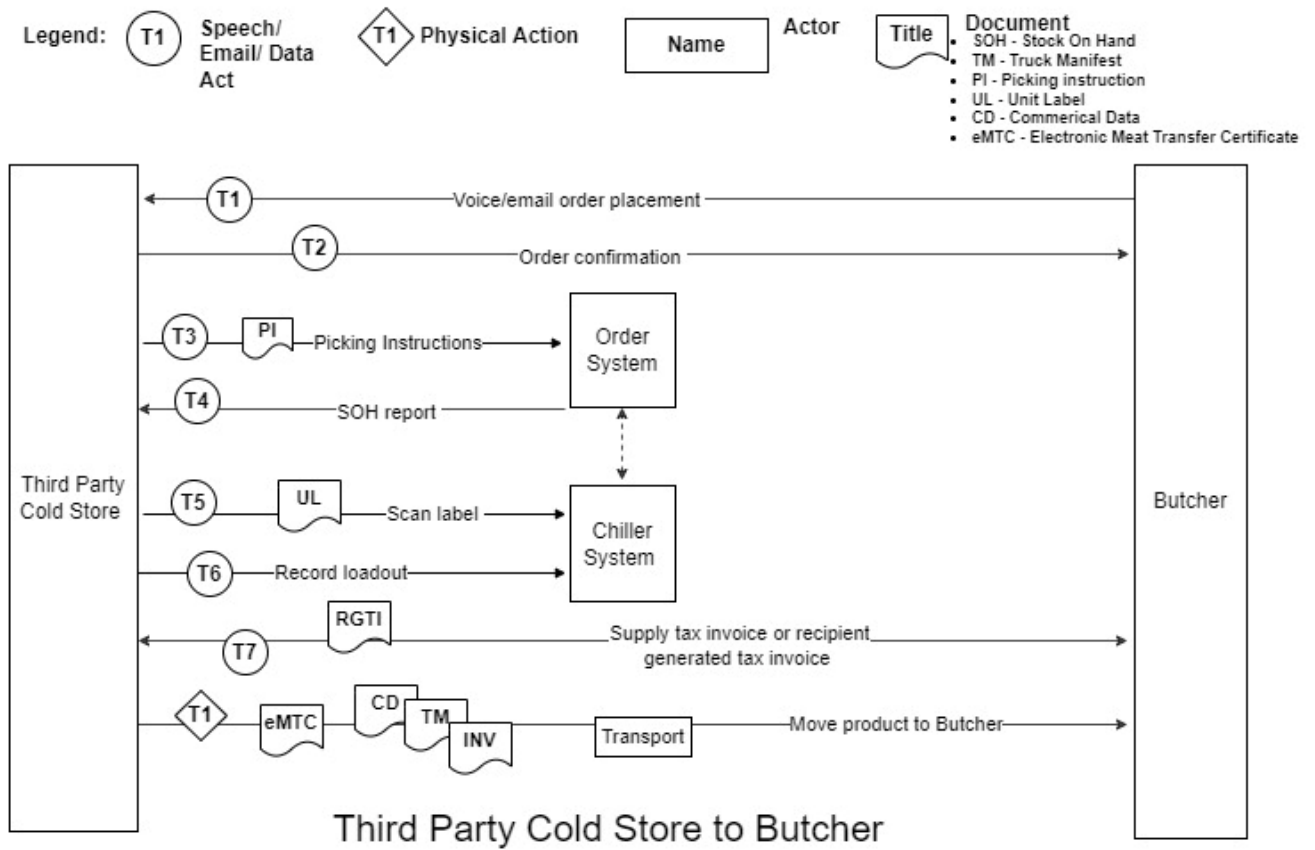

Figure 89. Data or information flows from the third-party cold store to butcher in the small stock supply chain.

5.2.3.3.7.3 Third Party Cold Store to Food Services

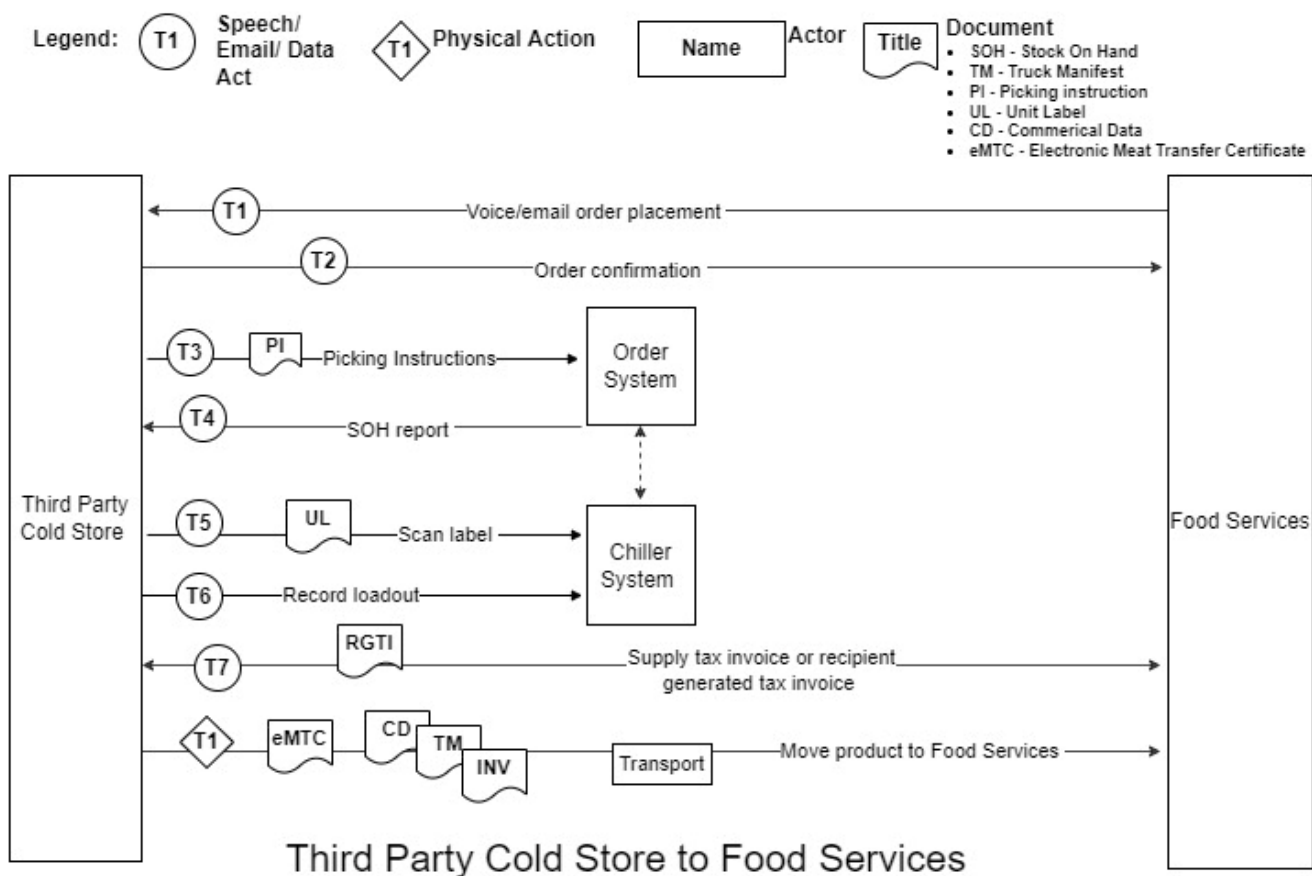

Figure 90. Data or information flows from the third-party cold store to food services in the small stock supply chain.

5.2.3.3.7.4 Third Party Cold Store to Value Added

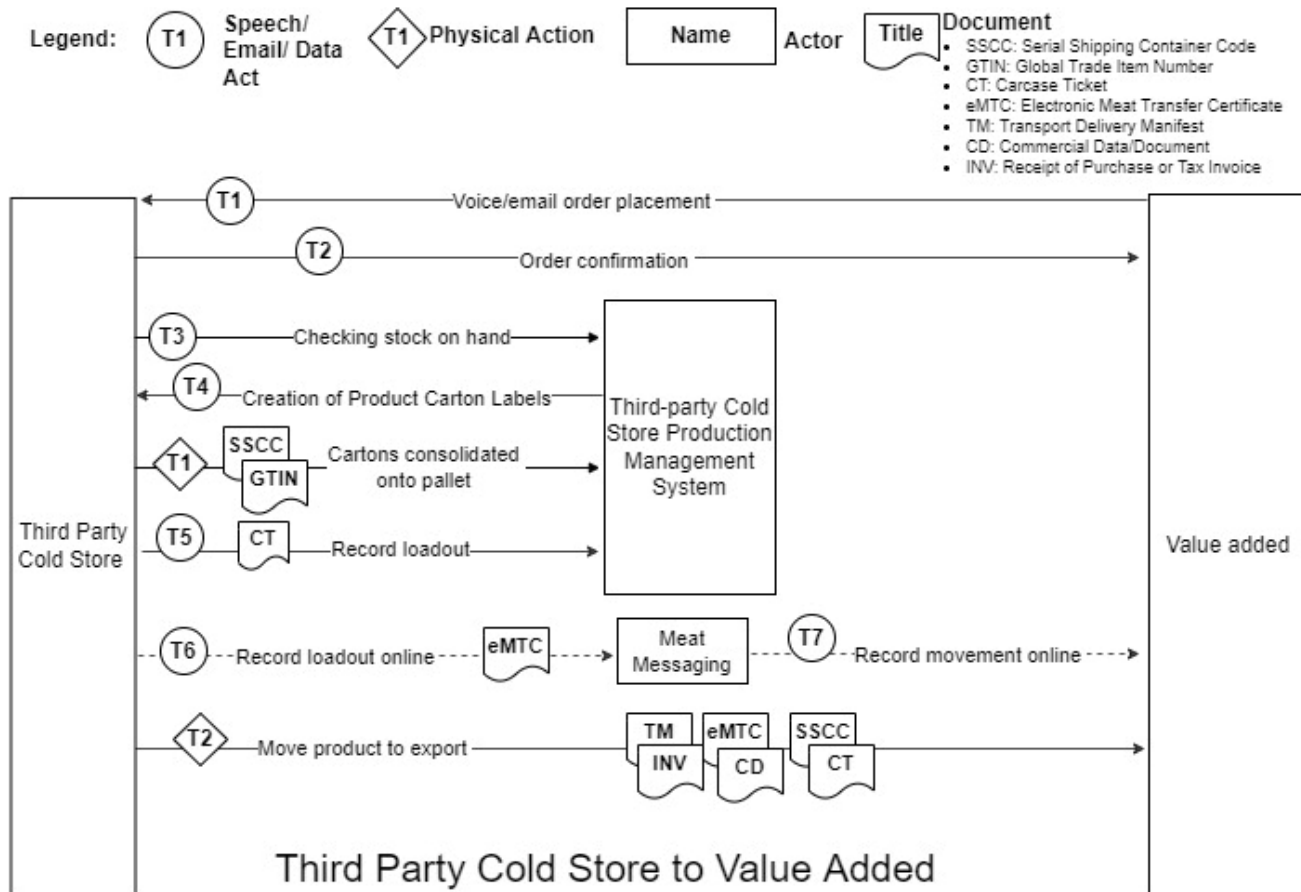

Figure 91. Data or information flows from the third-party cold store to value added in the small stock supply chain.

5.2.3.3.7.5 Third Party Cold Store to Non-packer Exporter

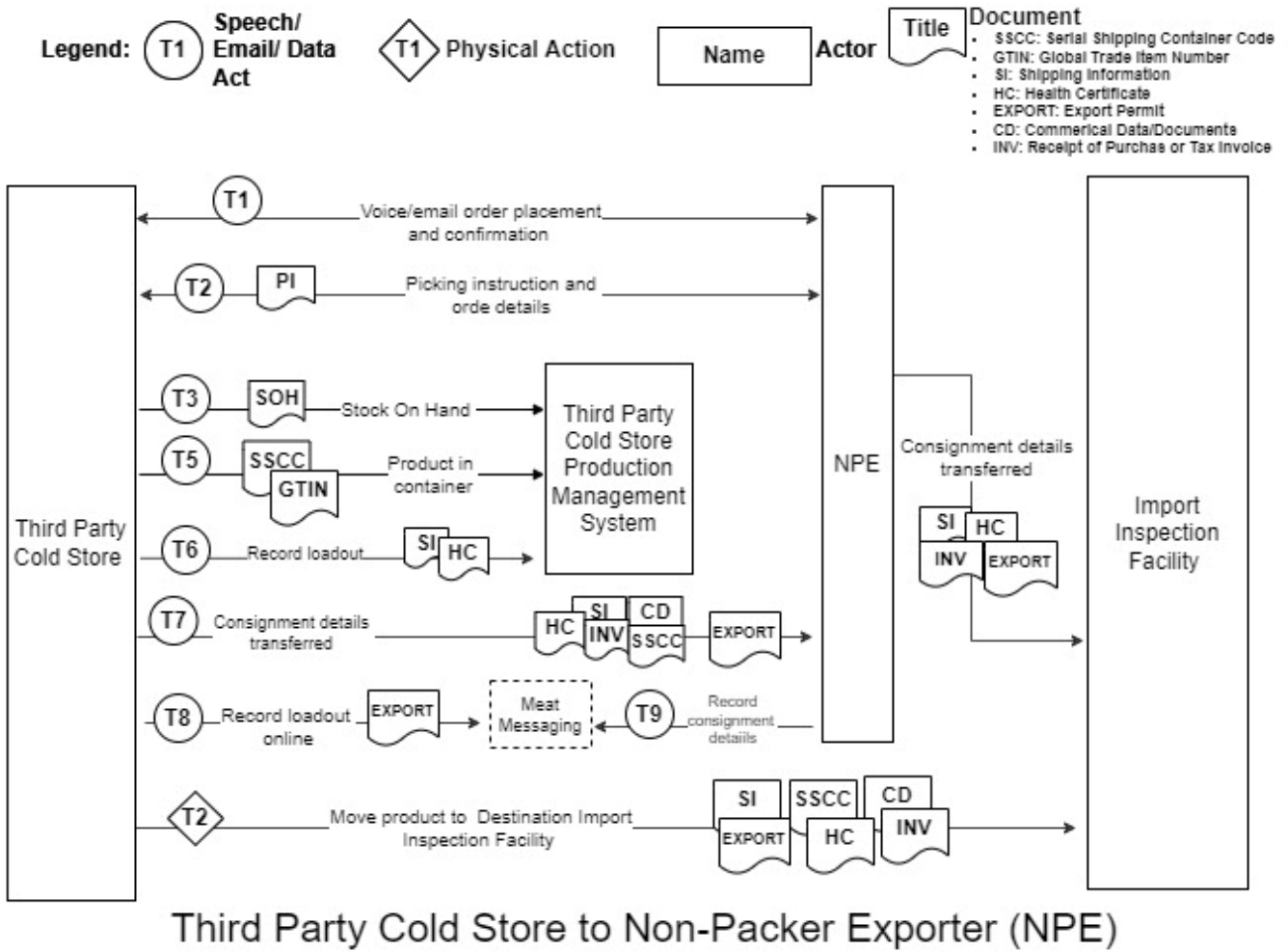
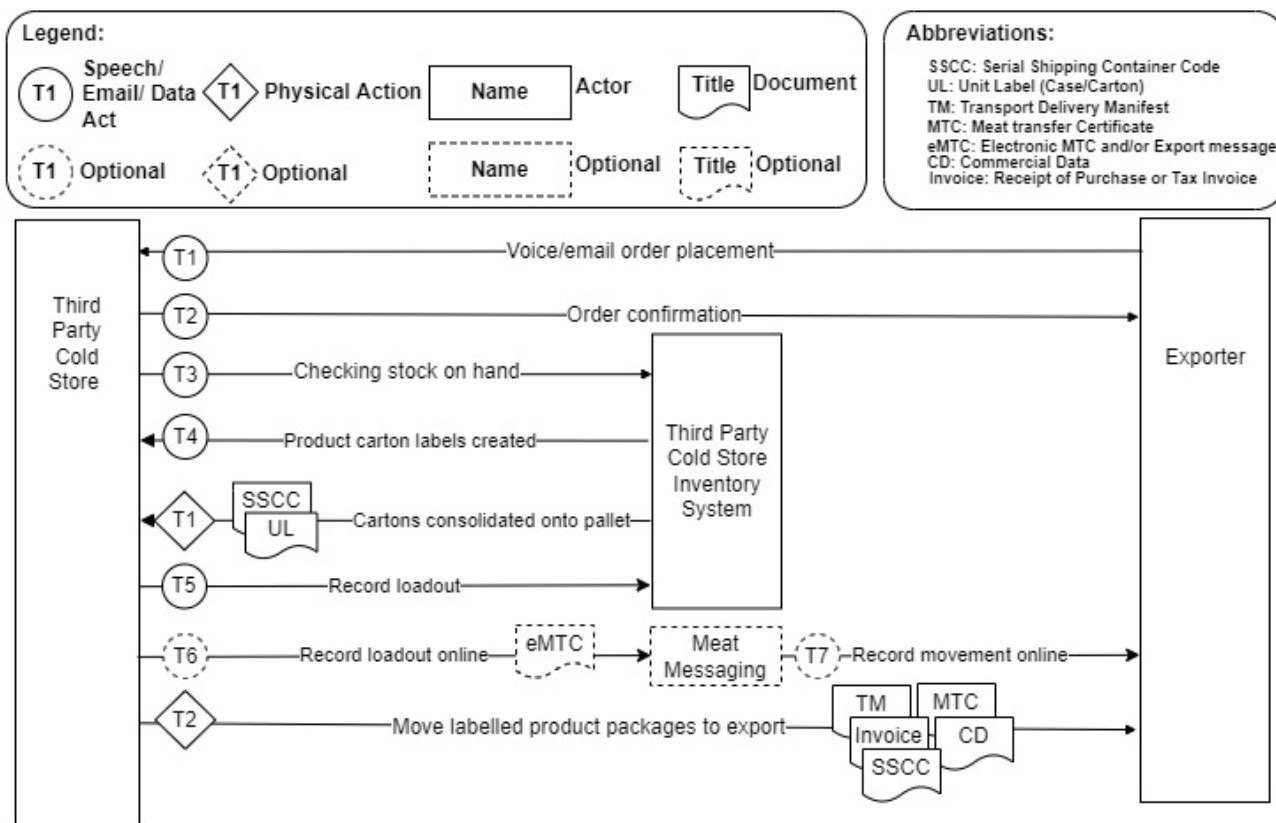

Figure 92. Data or information flows from the third-party cold store to non-packer exporter in the small stock supply chain.

5.2.3.3.7.6 Third Party Cold Store to Export



Third Party Cold Store to Export

Figure 93. Data or information flows the third-party cold store to export in the small stock supply chain

5.2.3.4 Supermarket

Supermarkets are product distribution centres whereby retail-ready product is sourced from suppliers (processors, independent boning room or third-party cold store) or product is prepared on site from carcass or cartoned product. These distribution centres may be chain or retail stores which assemble these goods, sourced from individual suppliers, for purchase by consumers. Product may be pre-packaged and branded by the supplier or by the supermarket and each item identified with a retail-ready product label. For MSA product, the supermarket must be an MSA licenced premises, and all products must be clearly labelled with the cooking method and MSA grade.

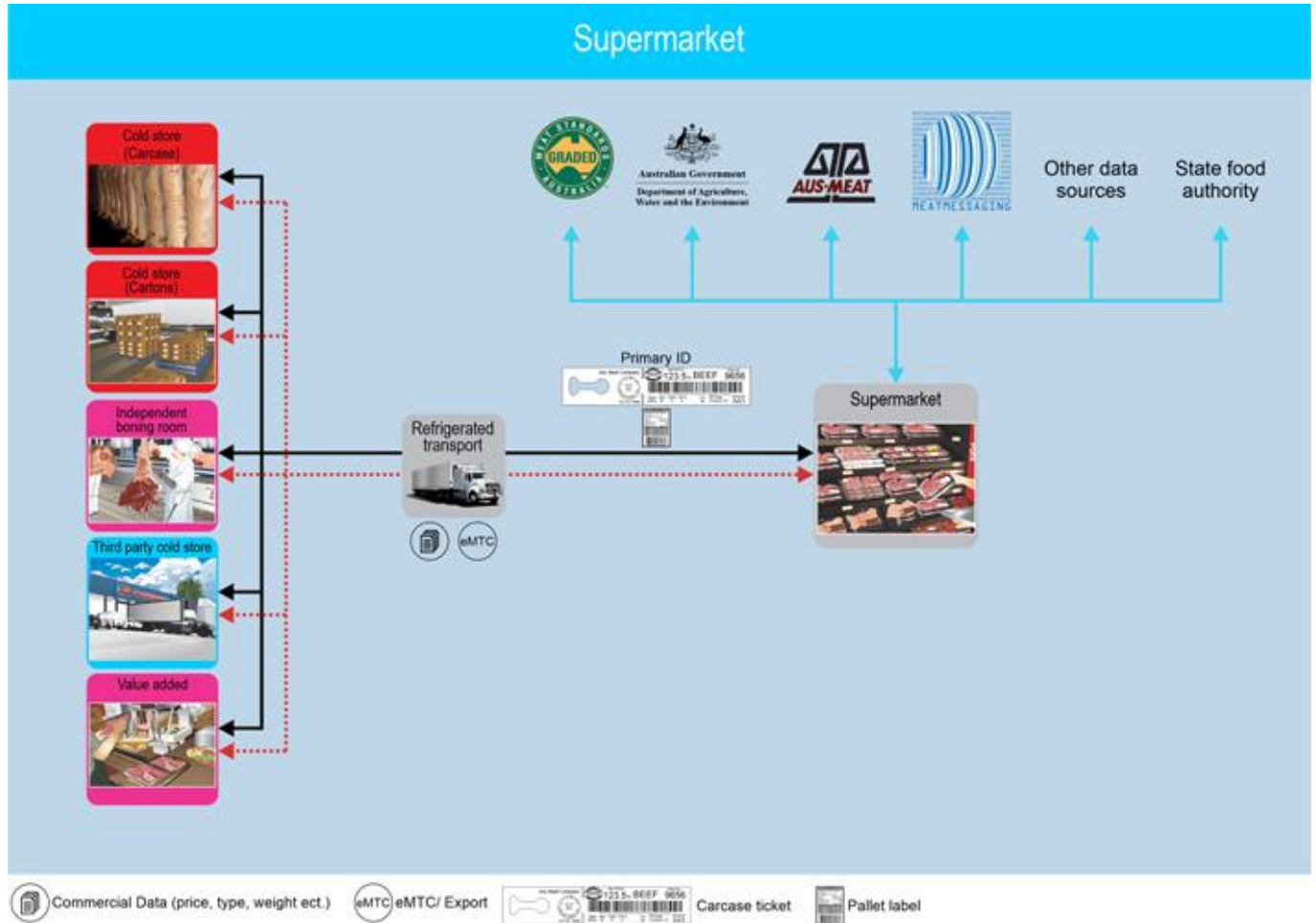

Figure 94. Inputs and outputs of the small stock supply chain supermarket sector.

5.2.3.4.1 Physical Inputs including Critical Tracking Events (CTEs)

The inputs for the domestic supermarket include meat product in carcass form for onsite butchering as well as pre-packaged product from boning room and value adding facilities. Critical Tracking Event related documentation for the movement of product into supermarkets includes standard movement documentation such as the Delivery Docket/Manifest, Meat Transfer Certificate, carton and pallet labels.

Critical Tracking Events (CTEs) are defined as those events which include the growing, receiving, transforming, creating and shipping of food products. Such events are critical to the traceability of product throughout the supply chain.

The CTEs associated with inputs to the supermarket system include the receipt of:

- Carcass

- Carton
- Pallet.

Table 75. Physical inputs and associated Critical Tracking Event related documents for a small stock supermarket system.

Event related to the inputs	Description of the inputs	Critical Tracking Event (CTE) related documents (including electronic)	More details
Carcase	The body of a slaughtered animal after bleeding. Becomes a dressed carcass when hide/skin, head, feet, and offal are removed.	Carcass Ticket, Delivery Docket/Manifest, Meat Transfer Certificate (MTC), MSA Carcass Ticket, Retail production management system, Receipt of purchase/Tax Invoice	
Carton	This is a case, crate, or barrel of product.	Carton label, Delivery Docket/Manifest, Meat Transfer Certificate (MTC), Official seal, Receipt of purchase/Tax Invoice, Retail production management system	
Pallet	A logistic unit which includes a number of cartons or goods items packed together for transport or storage purposes.	Delivery Docket/Manifest, Meat Transfer Certificate (MTC), Receipt of purchase/Tax Invoice, Retail production management system, SSCC/Pallet label	

5.2.3.4.2 Information Inputs including Key Data Elements (KDEs)

Key Data Elements (KDEs) are defined as those elements which are key in identifying and tracing the Critical Tracking Event (CTE). Information inputs or KDEs for the movement of meat product into the supermarket can be found on Critical Tracking Event related documentation and is stored in the retailer's production management system.

Table 76. Information inputs, Key Data Elements and Critical Tracking Event related documentation for a small stock supermarket system.

Attributes (including KDEs)	Description of the Attributes (including KDEs)	Is a KDE	Critical Tracking Event (CTE) related documents (including electronic)	More details
Body number	This is a number assigned to each carcass by the processor for identification purposes.	Yes	Carcass Ticket, Retail production management system	
Company/product code	This is an in-house code for the identification of the product in the unit.	Yes	Carton label, Receipt of purchase/Tax Invoice, Retail production management system, SSCC/Pallet label	
Consignment Serial Shipping Container Code (SSCC)	Encoded in the GS1 barcode, this is a unique number which identifies the individual logistic unit i.e., shipment/message that is assigned by the establishment constructing the unit. The SSCC remains the same for the life of the logistic unit.	Yes	Meat Transfer Certificate (MTC), Retail production management system, SSCC/Pallet label	For more information visit the GS1 website.

Contract number	This is a unique number allocated to the contract by the seller.	Yes	Delivery Docket/Manifest, Retail production management system	
Count of Trade Items	Usually encoded in the GS1 barcode, this is the number of trade items e.g., cartons in the logistic unit.	Yes	Delivery Docket/Manifest, Retail production management system, SSCC/Pallet label	For more information visit the GS1 website.
Date	This is the date of signing or of which a record entry or transaction was made.	Yes	Delivery Docket/Manifest, Meat Transfer Certificate (MTC), Receipt of purchase/Tax Invoice Retail, production management system	
Delivery Docket/Manifest number	This is a unique number allocated to the docket for identification purposes.	Yes	Delivery Docket/Manifest, Retail production management system	
From Establishment number	A number issued by Federal and State Authorities to identify the originating site from which meat or meat products were distributed to domestic or export markets. For transfer certificates, the Establishment numbers for both the dispatching and receiving establishments are recorded.	Yes	Carcase Ticket, Carton label, Delivery Docket/Manifest, Meat Transfer Certificate (MTC), Retail production management system, SSCC/Pallet label	
Global Trade Item Number (GTIN)	Encoded in the GS1 barcode, the GTIN is a globally unique 14-digit number used to identify trade items, products, or services.	Yes	Carcase Ticket, Carton label, Retail production management system, SSCC/Pallet label	For more information visit the GS1 website.
GTIN of Contained Trade Items	Encoded in the GS1 barcode, the GTIN of the contained trade items is a globally unique 14-digit number used to identify trade items, products, or services in the logistic unit.	Yes	Retail production management system, SSCC/Pallet label	For more information visit the GS1 website.
Lot number	A lot is a number assigned by the processor to each group of livestock consigned to slaughter and is usually vendor specific.	Yes	Carcase Ticket, Retail production management system	
Movement date	The date on which livestock or other products (e.g., feed or meat products) were transported between PICs/establishments.	Yes	Delivery Docket/Manifest, Meat Transfer Certificate (MTC), Retail production management system	
MSA eating quality group/grade	This identifies carcasses with similar MSA and eating quality grades, these may align with brands packed by the processor for logistic simplicity. Carcasses are grouped	Yes	MSA Carcase Ticket, Retail production management system, Receipt of	For more information on MSA visit the MLA website.

	for boning according to eating quality grades.		purchase/Tax Invoice, Retail production management system	
Net Weight (Kilograms)	Usually encoded in the GS1 barcode, the Net Weight is a variable measure of the trade item e.g., carton, pallet or shipment recorded in kilograms.	Yes	Carcase Ticket, Carton label, Retail production management system, SSCC/Pallet label	For more information visit the GS1 website.
Official mark	Any stamp, seal, label, or mark that is declared by the regulations to be an official mark. An official mark signifies that the product has been inspected by and approved as safe for human consumption by an Authorised Officer.	Yes	Carcase Ticket, Carton label, Retail production management system, SSCC/Pallet label	
Order date	This is the date on which the purchase order or contract was raised by the buyer.	Yes	Delivery Docket/Manifest, Retail production management system	
Packaging Date	Encoded in the GS1 barcode, the Packaging Date is the date on which the item was packaged and is recorded in the format year, month, day (YYMMDD).	Yes	Carton label, Retail production management system, SSCC/Pallet label	For more information visit the GS1 website.
Packaging Date Range	This includes the oldest and newest packaging dates for the logistic unit.	Yes	Retail production management system, SSCC/Pallet label	For more information visit the GS1 website.
Pallet Serial Shipping Container Code (SSCC)	Encoded in the GS1 barcode, this is a unique number which identifies the individual logistic unit i.e., pallet that is assigned by the establishment constructing the unit. The SSCC remains the same for the life of the logistic unit.	Yes	Meat Transfer Certificate (MTC), Retail production management system, SSCC/Pallet label	For more information visit the GS1 website.
Production Date (YYMMDD)	Encoded in the GS1 barcode, this is the 'kill' or slaughter' date of the product and is recorded in the format year, month, day (YYMMDD).	Yes	Carcase Ticket, Meat Transfer Certificate (MTC), Retail production management system	For more information visit the GS1 website.
Recipient Australian Business Number (ABN)	This is an 11-digit registration number, issued by the Australian Tax Office, used to identify businesses.	Yes	Receipt of purchase/Tax Invoice, Retail production management system	For more information visit the ATO website.
Seal Serial Number	This is a unique serial number printed on any tamper-evident seal issued by the Department.	Yes	Meat Transfer Certificate (MTC), Official seal, Retail production management system	For more information visit the Australian Government Federal Register of Legislation.
Seller/Supplier Australian Business Number (ABN)	This is an 11-digit registration number, issued by the Australian Tax Office, used to identify businesses.	Yes	Receipt of purchase/Tax Invoice, Retail production management system	For more information visit the ATO website.
Serial Number	Encoded in the GS1 barcode, this is a code, numeric or alphanumeric, assigned to an	Yes	Carcase Ticket, Carton label, Retail	For more information visit the GS1 website.

	individual instance of an item for its lifetime.		production management system	
Shipping Mark	Also known as a port mark, this is a code comprising of three letters representing the foreign establishment number and the last nine digits of the consignment SSCC.	Yes	Delivery Docket/Manifest, Retail production management system, SSCC/Pallet label	
To Establishment number	A number issued by Federal and State Authorities to identify the originating site from which meat or meat products were distributed to domestic or export markets. For transfer certificates, the Establishment numbers for both the dispatching and receiving establishments are recorded.	Yes	Meat Transfer Certificate (MTC), Retail production management system	
Trade description	This is a collective set of words that says what the product is and may include information such as species, net weight of product, name and address of establishments, category ciphers, market endorsements, MSA eating quality etc.	Yes	Carcase Ticket, Carton label, Delivery Docket/Manifest, Meat Transfer Certificate (MTC), Retail production management system, SSCC/Pallet label	
Transfer Certificate number	A unique certificate number issued for traceability purposes.	Yes	Meat Transfer Certificate (MTC), Retail production management system	
Transport registration number	The registration number of the vehicle in which the animals or product were transported. For shipments of product this will be a shipping container number.	Yes	Delivery Docket/Manifest, Meat Transfer Certificate (MTC), Retail production management system	

5.2.3.4.3 Physical Outputs including Critical Tracking Events (CTEs)

Retail-ready meat products are the outputs of the supermarket system. Being purchased by consumers, CTE documentation includes the product label and receipt of purchase with product exiting the system being recorded in the retailer's production management system.

Critical Tracking Events (CTEs) are defined as those events which include the growing, receiving, transforming, creating, and shipping of food products. Such events are critical to the traceability of product throughout the supply chain.

The CTEs associated with the outputs of the supermarket system include the movement of:

- Retail Ready Product

off the property, premises, or supply chain sector.

Table 77. Physical outputs and associated Critical Tracking Event related documents for a small stock supermarket system.

Event related to the inputs	Description of the inputs	Critical Tracking Event (CTE) related documents (including electronic)	More details
Retail Ready Product	These are packaged meat products that are ready to be retailed and purchased by consumers.	Receipt of purchase/Tax Invoice, Retail product label, Retail production management system	

5.2.3.4.4 Information Outputs including Key Data Elements (KDEs)

Key Data Elements (KDEs) are defined as those elements which are key in identifying and tracing the Critical Tracking Event (CTE). Information outputs from the supermarket system include KDEs which can be drawn from CTE documentation such the product label and receipt of purchase. This may include purchase date, product code and application identifiers on the GS1 barcode.

Table 78. Information outputs, Key Data Elements and Critical Tracking Event related documentation for a small stock supermarket system.

Attributes (including KDEs)	Description of the Attributes (including KDEs)	Is a KDE	Critical Tracking Event (CTE) related documents (including electronic)	More details
Company/product code	This is an in-house code for the identification of the product in the unit.	Yes	Receipt of purchase/Tax Invoice, Retail production management system	
Date	This is the date of signing or of which a record entry or transaction was made.	Yes	Receipt of purchase/Tax Invoice, Retail production management system	
GS1 compliant numbering and barcode	Numbering and barcode compliant to the GS1 standards and as specified by the contract between the seller and the recipient i.e., retailer.	Yes	Retail product label, Retail production management system	For more information visit the GS1 website.
MSA Licence Number	Any establishment consigning, supplying, or identifying MSA Certified Product must be registered and have a unique MSA Licence Number.	Yes	Receipt of purchase/Tax Invoice, Retail production management system	For more information on MSA visit the MLA website.
Recipient Australian Business Number (ABN)	This is an 11-digit registration number, issued by the Australian Tax Office, used to identify businesses.	Yes	Receipt of purchase/Tax Invoice, Retail production management system	For more information visit the ATO website.
Seller/Supplier Australian Business Number (ABN)	This is an 11-digit registration number, issued by the Australian Tax Office, used to identify businesses.	Yes	Receipt of purchase/Tax Invoice, Retail production management system	For more information visit the ATO website.

5.2.3.4.5 Regulatory and Industry Programs

- Meat Standards Australia (MSA)
- AUS-MEAT
- Australian Meat Industry Council (AMIC)
- Department of Agriculture
- Meat Messaging

- State food authority
- Other data sources

5.2.3.4.6 Supply Chain Node Traceability

The traceability of retail-ready product back to the live animal (depending on the NLIS tag type), or consignment group and property of origin is dependent on the form in which product enters the retail premises. This may include whole carcass, cartoned or palletised form. Further, the level of traceability for each input form is dependent on the packaging processes of the retailer. For example, whole carcass product may or may not be fully traceable back to the live animal or consignment group. Where this is true, carcasses are broken down into retail cuts on site and may be packaged individually and labelled with a unique, serialised retail label. For this product, traceability back to the live animal or consignment group is possible and can be done by the processing establishment where the animal was slaughtered. Here, carcasses are issued a carcass ticket which correlates to the PIC number or live animal identifier and contains key information, including GS1 meat industry barcode, body number, processing establishment number and production date or 'kill date'. This information is uploaded to the NLIS Database, by the processor, under the processing establishments Property Identification Code (PIC). Thus, there is the potential to trace whole carcasses entering retail premises back to the individual live animal, or consignment group and property of origin. Where carcass retail cuts are not individually packaged or are derived from palletised or cartoned product, retail-ready product may have the same batch traceability limitations as per boning room and value-added product. Please refer to Boning room and Value Added 'Supply Chain Node Traceability' for more information.

5.2.3.4.7 Data flow diagrams

Table 79. Data flow diagrams for the inputs and outputs of a small stock supermarket system.

Direction	Description
Output	Cold Store (carcass) to Supermarket
Input	Cold Store (cartons)
Output	Independent Boning Room to Supermarket
Output	Third Party Cold Store to Supermarket
Output	Value Added to Supermarket

5.2.3.4.7.1 Cold Store (carcase) to Supermarket

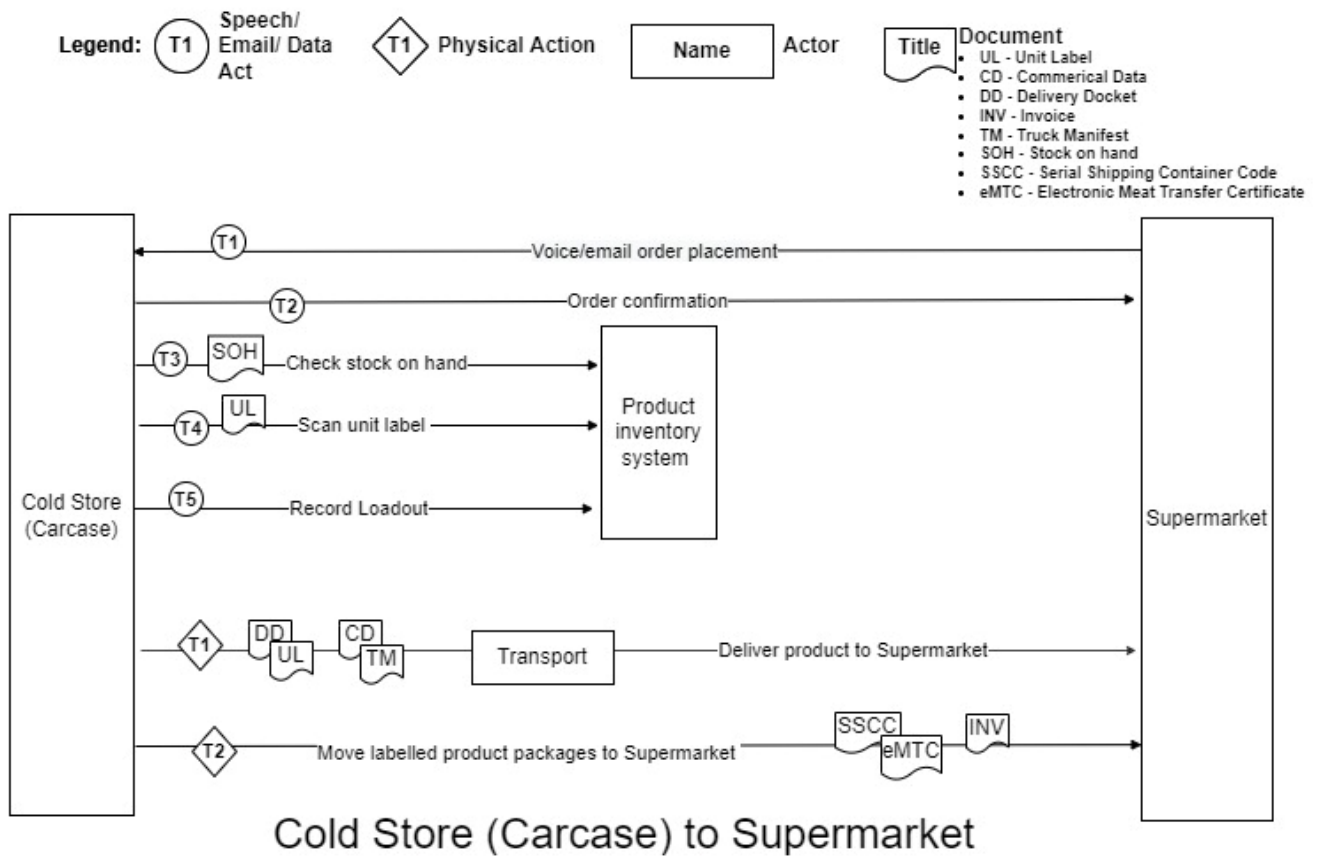

Figure 95. Data or information flows from the cold store (carcase) to supermarket in the small stock supply chain.

5.2.3.4.7.2 Cold Store (cartons) to Supermarket

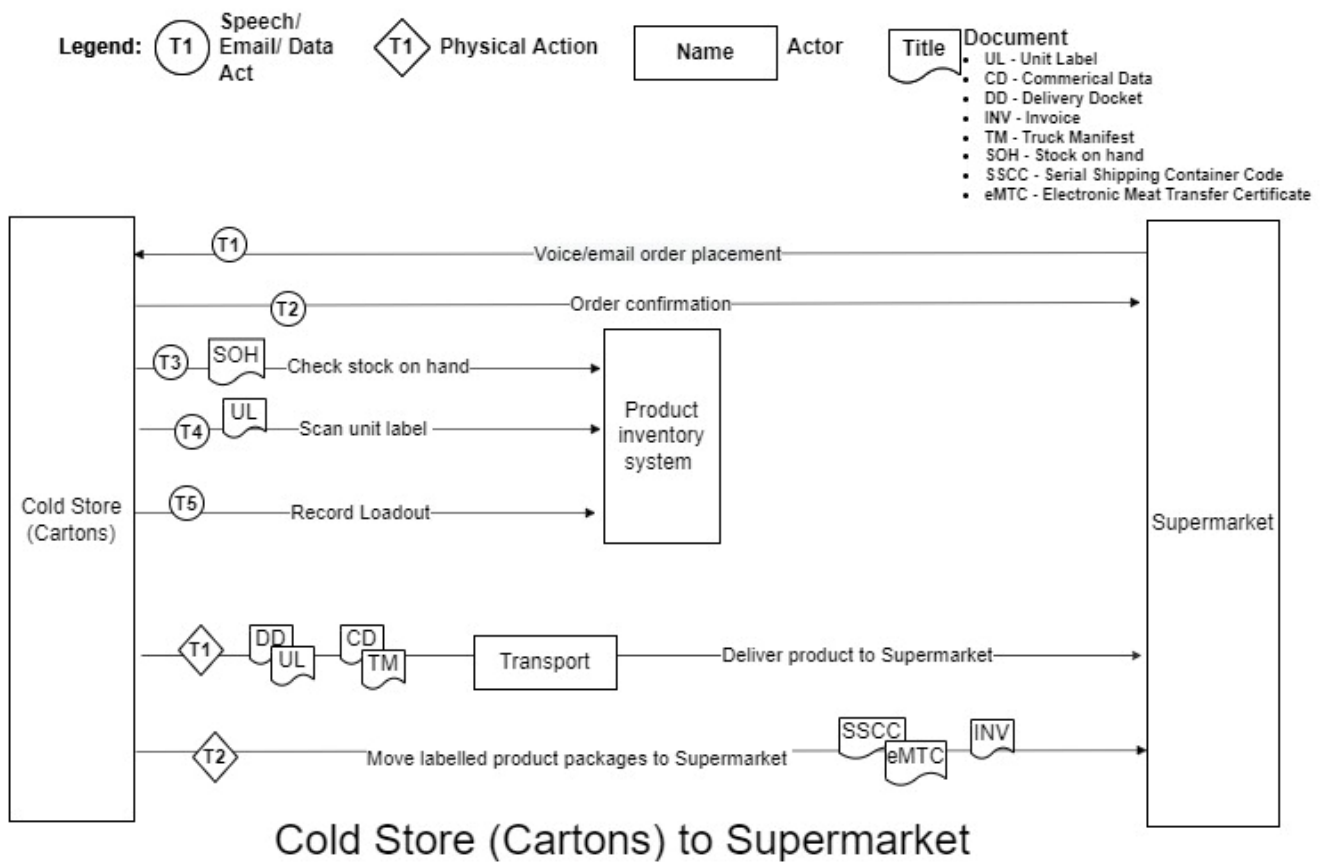

Figure 96. Data or information flows from the cold store (cartons) to supermarkets in the small stock supply chain.

5.2.3.4.7.3 Independent Boning Room to Supermarket

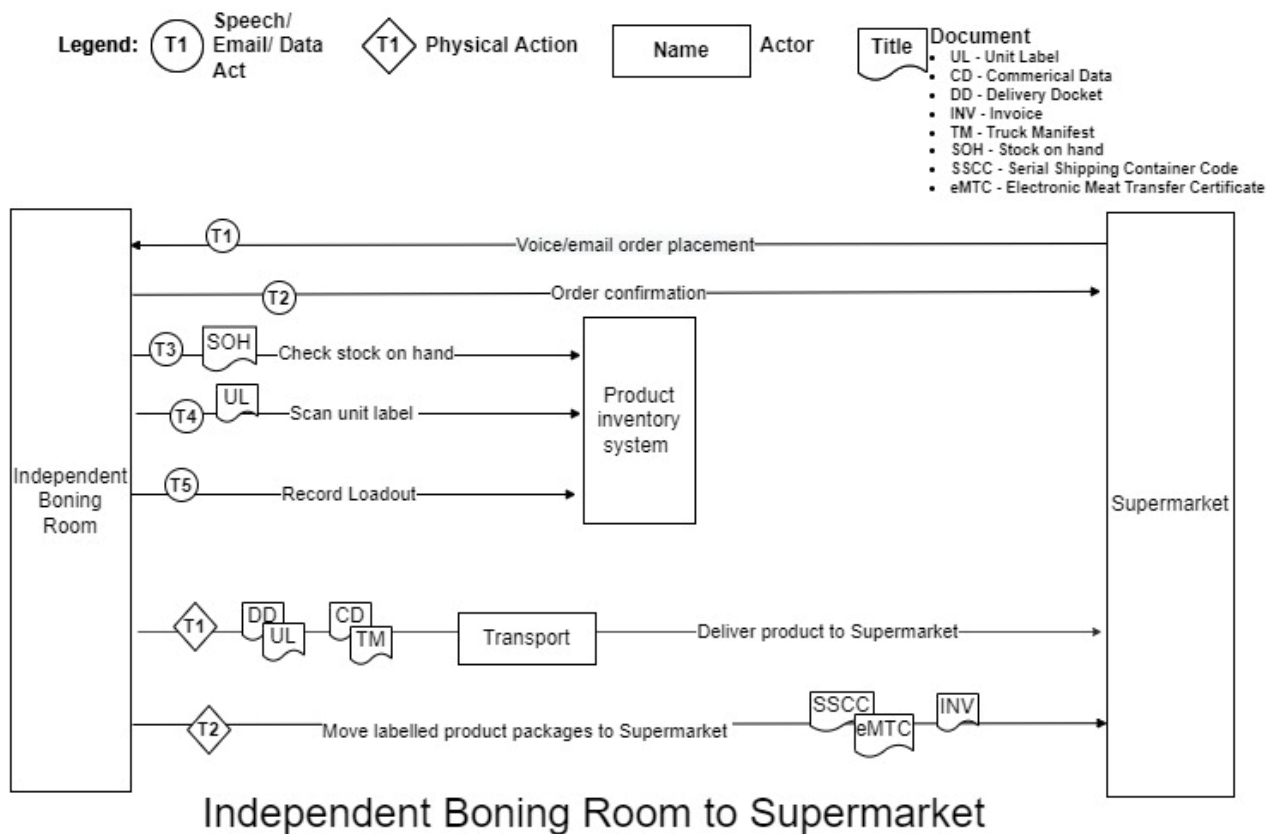

Figure 97. Data or information flows from the independent boning room to supermarket in the small stock supply chain.

5.2.3.4.7.4 Third Party Cold Store to Supermarket

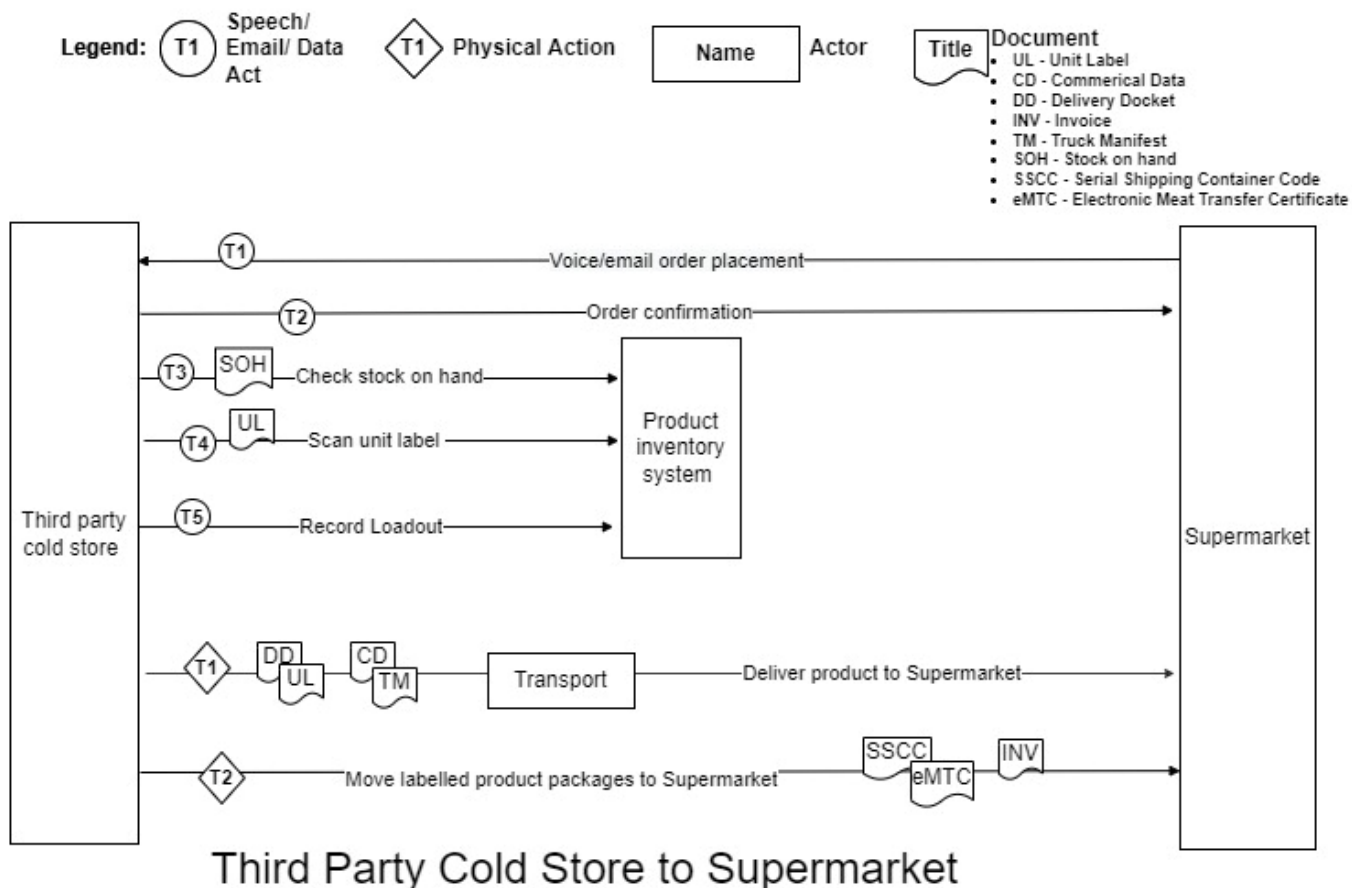

Figure 98. Data or information flows from the third-party cold store to supermarket in the small stock supply chain.

5.2.3.4.7.5 Value Added to Supermarket

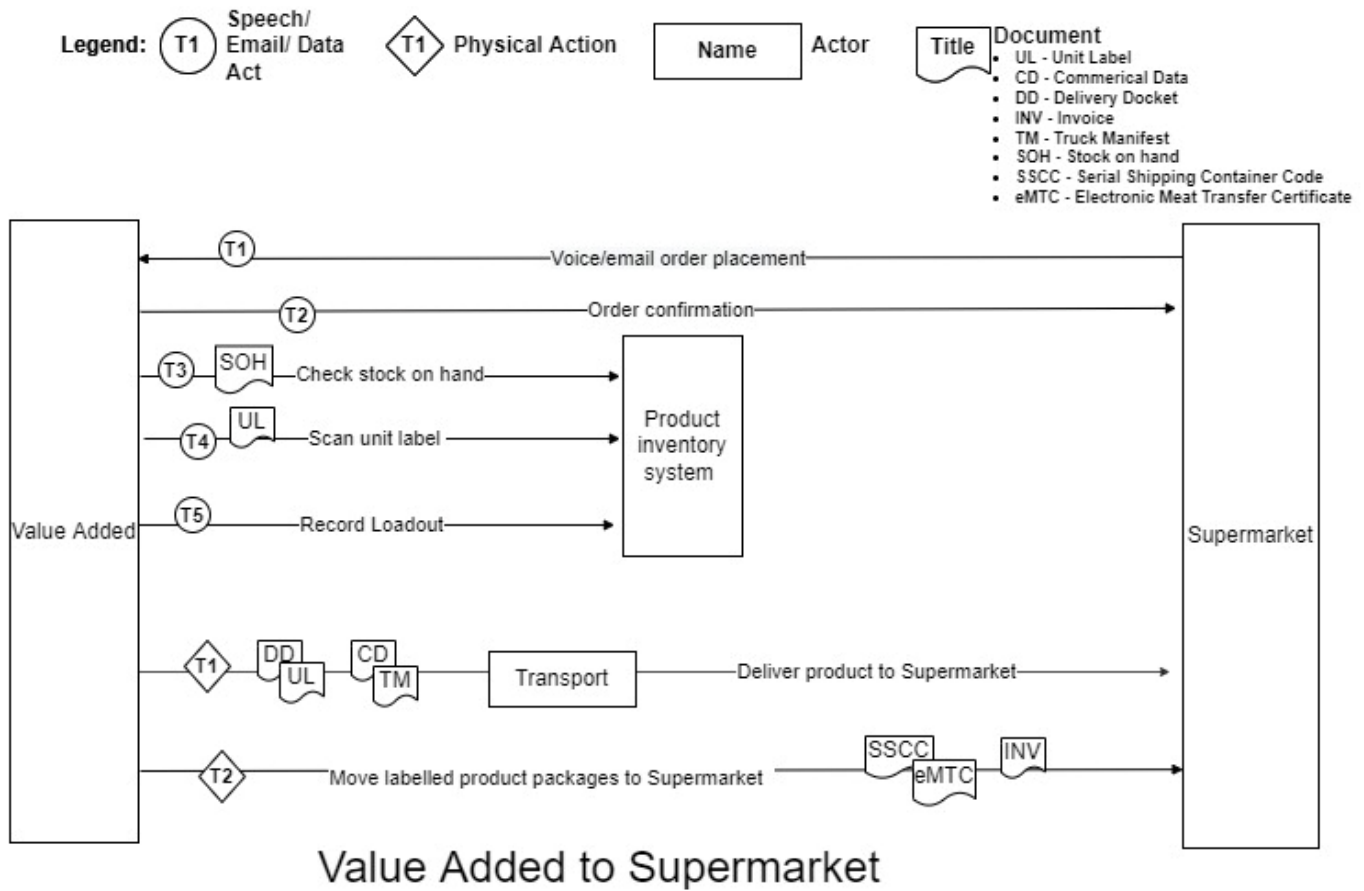

Figure 99. Data or information flows from value added to supermarket in the small stock supply chain.

5.2.3.5 Butcher

Butchers are meat and meat product retail stores whereby carcass or cartoned product is sourced from processors, third-party cold stores, independent boning rooms, or value adders, and is prepared for sale to the consumer. This preparation may include value-adding processes whereby a new variety of cuts is provided, the presentation of products is altered, or additional ingredients are added to create new products or enhance the profitability of raw products. For example, cutting primal products into steaks, roasts, or diced products, marinating meat to save time for the consumer, as well as making specialty goods such as mixed sausages and offal. For MSA product, the butcher must be an MSA licenced premises, and all products must be clearly labelled with the cooking method and MSA grade.

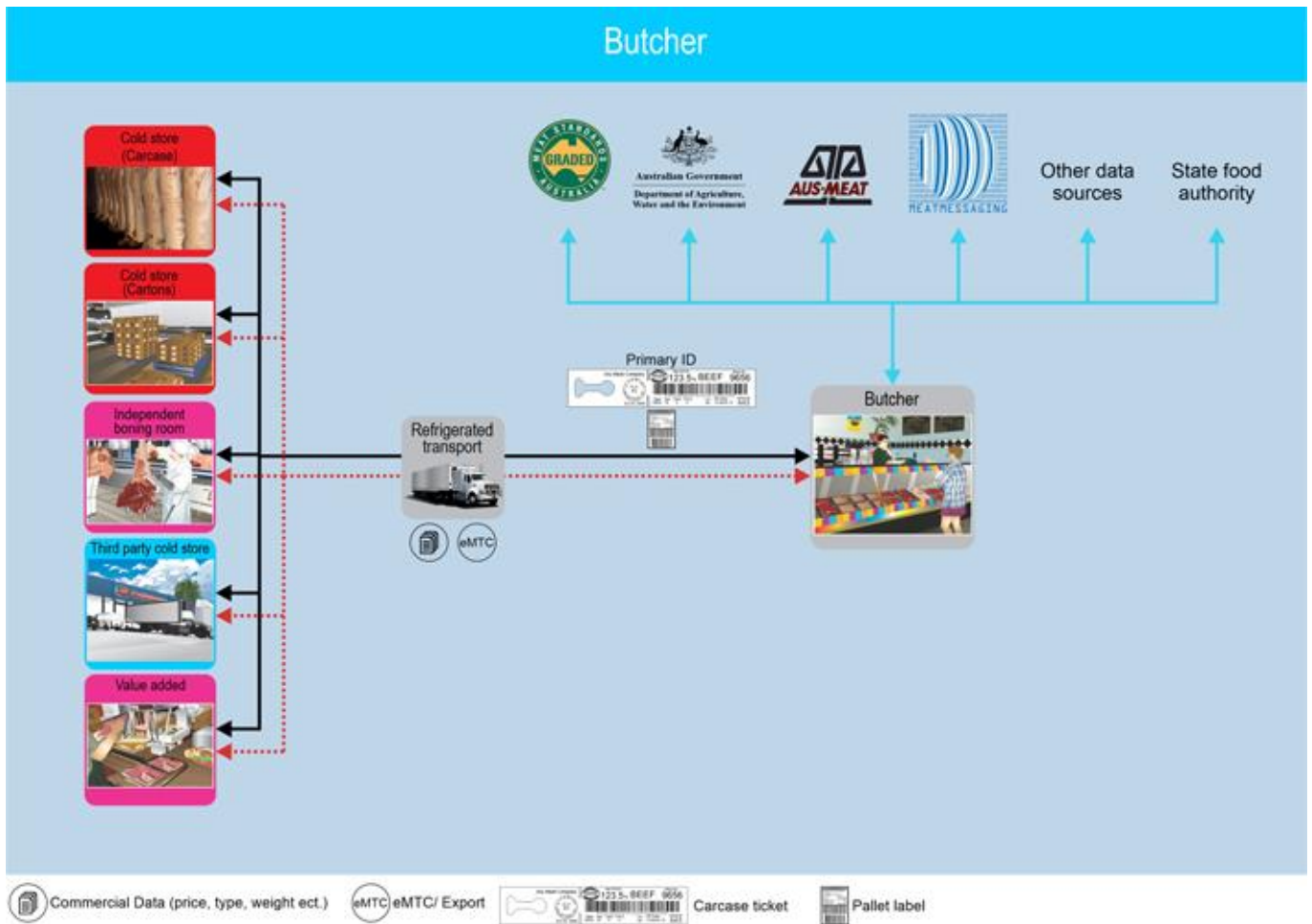

Figure 100. Inputs and outputs of the small stock supply chain butcher sector.

5.2.3.5.1 Physical Inputs including Critical Tracking Events (CTEs)

The inputs to the butcher system include meat product in carcase form for onsite butchering as well primal or value-added product from boning room and value adding facilities. Critical Tracking Event related documentation for the movement of product into butchers includes standard movement documentation such as the Delivery Docket/Manifest, Meat Transfer Certificate, carton, and pallet labels.

Critical Tracking Events (CTEs) are defined as those events which include the growing, receiving, transforming, creating and shipping of food products. Such events are critical to the traceability of product throughout the supply chain.

The CTEs associated with inputs to the butcher system include the receipt of:

- Carcase
- Carton
- Pallet.

Table 80. Physical inputs and associated Critical Tracking Event related documents for a small stock butcher system.

Event related to the inputs	Description of the inputs	Critical Tracking Event (CTE) related documents (including electronic)	More details
Carcase	The body of a slaughtered animal after bleeding. Becomes a dressed carcass when hide/skin, head, feet, and offal are removed.	Carcass Ticket, Delivery Docket/Manifest, Meat Transfer Certificate (MTC), MSA Carcass Ticket, Receipt of purchase/Tax Invoice, Retail production management system	
Carton	This is a case, crate, or barrel of product.	Carton label, Delivery Docket/Manifest, Meat Transfer Certificate (MTC), Official seal, Receipt of purchase/Tax Invoice, Retail production management system	
Pallet	A logistic unit which includes a number of cartons or goods items packed together for transport or storage purposes.	Delivery Docket/Manifest, Meat Transfer Certificate (MTC), Receipt of purchase/Tax Invoice, Retail production management system, SSCC/Pallet label	

5.2.3.5.2 Information Inputs including Key Data Elements (KDEs)

Key Data Elements (KDEs) are defined as those elements which are key in identifying and tracing the Critical Tracking Event (CTE). Information inputs or KDEs for the movement of meat product into the butcher system can be found on Critical Tracking Event related documentation and is stored in the retailer's production management system.

Table 81. Information inputs, Key Data Elements and Critical Tracking Event related documentation for a small stock butcher system.

Attributes (including KDEs)	Description of the Attributes (including KDEs)	Is a KDE	Critical Tracking Event (CTE) related documents (including electronic)	More details
Body number	This is a number assigned to each carcass by the processor for identification purposes.	Yes	Carcass Ticket, Retail production management system	
Company/product code	This is an in-house code for the identification of the product in the unit.	Yes	Carton label, Receipt of purchase/Tax Invoice, Retail production management system, SSCC/Pallet label	
Consignment Serial Shipping Container Code (SSCC)	Encoded in the GS1 barcode, this is a unique number which identifies the individual logistic unit i.e., shipment/message that is assigned by the establishment constructing the unit. The SSCC remains the same for the life of the logistic unit.	Yes	Meat Transfer Certificate (MTC), Retail production management system, SSCC/Pallet label	For more information visit the GS1 website.
Contract number	This is a unique number allocated to the contract by the seller.	Yes	Delivery Docket/Manifest, Retail production management system	

Count of Trade Items	Usually encoded in the GS1 barcode, this is the number of trade items e.g., cartons in the logistic unit.	Yes	Delivery Docket/Manifest, Retail production management system, SSCC/Pallet label	For more information visit the GS1 website.
Date	This is the date of signing or of which a record entry or transaction was made.	Yes	Delivery Docket/Manifest, Meat Transfer Certificate (MTC), Receipt of purchase/Tax Invoice, Retail production management system	
Delivery Docket/Manifest number	This is a unique number allocated to the docket for identification purposes.	Yes	Delivery Docket/Manifest, Retail production management system	
From Establishment number	A number issued by Federal and State Authorities to identify the originating site from which meat or meat products were distributed to domestic or export markets. For transfer certificates, the Establishment numbers for both the dispatching and receiving establishments are recorded.	Yes	Carcase Ticket, Carton label, Delivery Docket/Manifest, Meat Transfer Certificate (MTC), Retail production management system, SSCC/Pallet label	
Global Trade Item Number (GTIN)	Encoded in the GS1 barcode, the GTIN is a globally unique 14-digit number used to identify trade items, products, or services.	Yes	Carcase Ticket, Carton label, Retail production management system, SSCC/Pallet label	For more information visit the GS1 website.
GTIN of Contained Trade Items	Encoded in the GS1 barcode, the GTIN of the contained trade items is a globally unique 14-digit number used to identify trade items, products, or services in the logistic unit.	Yes	Retail production management system, SSCC/Pallet label	For more information visit the GS1 website.
Lot number	A lot is a number assigned by the processor to each group of livestock consigned to slaughter and is usually vendor specific.	Yes	Carcase Ticket, Retail production management system	
Movement date	The date on which livestock or other products (e.g., feed or meat products) were transported between PICs/establishments.	Yes	Delivery Docket/Manifest, Meat Transfer Certificate (MTC), Retail production management system	
MSA eating quality group/grade	This identifies carcasses with similar MSA and eating quality grades, these may align with brands packed by the processor for logistic simplicity. Carcasses are grouped for boning according to eating quality grades.	Yes	MSA Carcase Ticket, Retail production management system	For more information on MSA visit the MLA website.
MSA Licence Number	Any establishment consigning, supplying, or identifying MSA Certified Product must	Yes	Receipt of purchase/Tax Invoice,	For more information on

	be registered and have a unique MSA Licence Number.		Retail production management system	MSA visit the MLA website.
Net Weight (Kilograms)	Usually encoded in the GS1 barcode, the Net Weight is a variable measure of the trade item e.g., carton, pallet or shipment recorded in kilograms.	Yes	Carcase Ticket, Carton label, Retail production management system, SSCC/Pallet label	For more information visit the GS1 website.
Official mark	Any stamp, seal, label, or mark that is declared by the regulations to be an official mark. An official mark signifies that the product has been inspected by and approved as safe for human consumption by an Authorised Officer.	Yes	Carcase Ticket, Carton label, Retail production management system, SSCC/Pallet label	
Order date	This is the date on which the purchase order or contract was raised by the buyer.	Yes	Delivery Docket/Manifest, Retail production management system	
Packaging Date	Encoded in the GS1 barcode, the Packaging Date is the date on which the item was packaged and is recorded in the format year, month, day (YYMMDD).	Yes	Carton label, Retail production management system, SSCC/Pallet label	For more information visit the GS1 website.
Packaging Date Range	This includes the oldest and newest packaging dates for the logistic unit.	Yes	Retail production management system, SSCC/Pallet label	For more information visit the GS1 website.
Pallet Serial Shipping Container Code (SSCC)	Encoded in the GS1 barcode, this is a unique number which identifies the individual logistic unit i.e., pallet that is assigned by the establishment constructing the unit. The SSCC remains the same for the life of the logistic unit.	Yes	Meat Transfer Certificate (MTC), Retail production management system, SSCC/Pallet label	For more information visit the GS1 website.
Production Date (YYMMDD)	Encoded in the GS1 barcode, this is the 'kill' or slaughter' date of the product and is recorded in the format year, month, day (YYMMDD).	Yes	Carcase Ticket, Meat Transfer Certificate (MTC), Retail production management system	For more information visit the GS1 website.
Recipient Australian Business Number (ABN)	This is an 11-digit registration number, issued by the Australian Tax Office, used to identify businesses.	Yes	Receipt of purchase/Tax Invoice, Retail production management system	For more information visit the ATO website.
Seal Serial Number	This is a unique serial number printed on any tamper-evident seal issued by the Department.	Yes	Meat Transfer Certificate (MTC), Official seal, Retail production management system	For more information visit the Australian Government Federal Register of Legislation.
Seller/Supplier Australian Business Number (ABN)	This is an 11-digit registration number, issued by the Australian Tax Office, used to identify businesses.	Yes	Receipt of purchase/Tax Invoice, Retail production management system	For more information visit the ATO website.
Serial Number	Encoded in the GS1 barcode, this is a code, numeric or alphanumeric, assigned to an individual instance of an item for its lifetime.	Yes	Carcase Ticket, Carton label, Retail production management system	For more information visit the GS1 website.

Shipping Mark	Also known as a port mark, this is a code comprising of three letters representing the foreign establishment number and the last nine digits of the consignment SSCC.	Yes	Delivery Docket/Manifest, Retail production management system, SSCC/Pallet label	
To Establishment number	A number issued by Federal and State Authorities to identify the originating site from which meat or meat products were distributed to domestic or export markets. For transfer certificates, the Establishment numbers for both the dispatching and receiving establishments are recorded.	Yes	Meat Transfer Certificate (MTC), Retail production management system	
Trade description	This is a collective set of words that says what the product is and may include information such as species, net weight of product, name and address of establishments, category ciphers, market endorsements, MSA eating quality etc.	Yes	Carcase Ticket, Carton label, Delivery Docket/Manifest, Meat Transfer Certificate (MTC), Retail production management system, SSCC/Pallet label	
Transfer Certificate number	A unique certificate number issued for traceability purposes.	Yes	Meat Transfer Certificate (MTC), Retail production management system	
Transport registration number	The registration number of the vehicle in which the animals or product were transported. For shipments of product this will be a shipping container number.	Yes	Delivery Docket/Manifest, Meat Transfer Certificate (MTC), Retail production management system	

5.2.3.5.3 Physical Outputs including Critical Tracking Events (CTEs)

Retail ready meat products are the outputs of the butcher system. Being purchased by consumers, CTE documentation includes the product label and receipt of purchase with product exiting the system being recorded in the retailer's production management system.

Critical Tracking Events (CTEs) are defined as those events which include the growing, receiving, transforming, creating and shipping of food products. Such events are critical to the traceability of product throughout the supply chain.

The CTEs associated with the outputs of the butcher system include the movement of:

- Retail Ready Product

off the property, premises, or supply chain sector.

Table 82. Physical outputs and associated Critical Tracking Event related documents for a small stock butcher system.

Event related to the inputs	Description of the inputs	Critical Tracking Event (CTE) related documents (including electronic)	More details
Retail Ready Product	These are packaged meat products that are ready to be retailed and purchased by consumers.	Receipt of purchase/Tax Invoice, Retail product label, Retail production management system	

5.2.3.5.4 Information Outputs including Key Data Elements (KDEs)

Key Data Elements (KDEs) are defined as those elements which are key in identifying and tracing the Critical Tracking Event (CTE). Information outputs from the butcher system include KDEs which can be drawn from CTE documentation such as the product label and receipt of purchase. This may include purchase date, product code and application identifiers on the GS1 barcode.

Table 83. Information outputs, Key Data Elements and Critical Tracking Event related documentation for a small stock butcher system.

Attributes (including KDEs)	Description of the Attributes (including KDEs)	Is a KDE	Critical Tracking Event (CTE) related documents (including electronic)	More details
Company/product code	This is an in-house code for the identification of the product in the unit.	Yes	Receipt of purchase/Tax Invoice, Retail production management system	
Date	This is the date of signing or of which a record entry or transaction was made.	Yes	Receipt of purchase/Tax Invoice, Retail production management system	
GS1 compliant numbering and barcode	Numbering and barcode compliant to the GS1 standards and as specified by the contract between the seller and the recipient i.e., retailer.	Yes	Retail product label, Retail production management system	
MSA Licence Number	Any establishment consigning, supplying, or identifying MSA Certified Product must be registered and have a unique MSA Licence Number.	Yes	Receipt of purchase/Tax Invoice, Retail production management system	For more information on MSA visit the MLA website.
Recipient Australian Business Number (ABN)	This is an 11-digit registration number, issued by the Australian Tax Office, used to identify businesses.	Yes	Receipt of purchase/Tax Invoice, Retail production management system	For more information visit the ATO website.
Seller/Supplier Australian Business Number (ABN)	This is an 11-digit registration number, issued by the Australian Tax Office, used to identify businesses.	Yes	Receipt of purchase/Tax Invoice, Retail production management system	For more information visit the ATO website.

5.2.3.5.5 Regulatory and Industry Programs

- Meat Standards Australia (MSA)
- AUS-MEAT
- Australian Meat Industry Council (AMIC)
- Department of Agriculture
- Meat Messaging

- State food authority
- Other data sources

5.2.3.5.6 Supply Chain Node Traceability

The traceability of retail-ready product back to the live animal (depending on the NLIS tag type), or consignment group and property of origin is dependent on the form in which product enters the retail premises. This may include whole carcass, cartoned or palletised form. Further, the level of traceability for each input form is dependent on the packaging processes of the retailer. For example, whole carcass product may or may not be fully traceable back to the live animal or consignment group. Where this is true, carcasses are broken down into retail cuts on site and may be packaged individually and labelled with a unique, serialised retail label. For this product, traceability back to the live animal or consignment group is possible and can be done by the processing establishment where the animal was slaughtered. Here, carcasses are issued a carcass ticket which correlates to the PIC number or live animal identifier and contains key information, including GS1 meat industry barcode, body number, processing establishment number and production date or 'kill date'. This information is uploaded to the NLIS Database, by the processor, under the processing establishments Property Identification Code (PIC). Thus, there is the potential to trace whole carcasses entering retail premises back to the individual live animal, or consignment group and property of origin. Where carcass retail cuts are not individually packaged or are derived from palletised or cartoned product, retail-ready product may have the same batch traceability limitations as per boning room and value-added product. Please refer to Boning room and Value Added 'Supply Chain Node Traceability' for more information.

5.2.3.5.7 Data flow diagrams

Table 84. Data flow diagrams for the inputs and outputs of a small stock butcher system.

Direction	Description
Output	Cold Store (carcass) to Butcher
Output	Cold Store (cartons) to Butcher
Output	Independent Boning Room to Butcher
Output	Third Party Cold Store to Butcher
Output	Value Added to Butcher

5.2.3.5.7.1 Cold Store (carcase) to Butcher

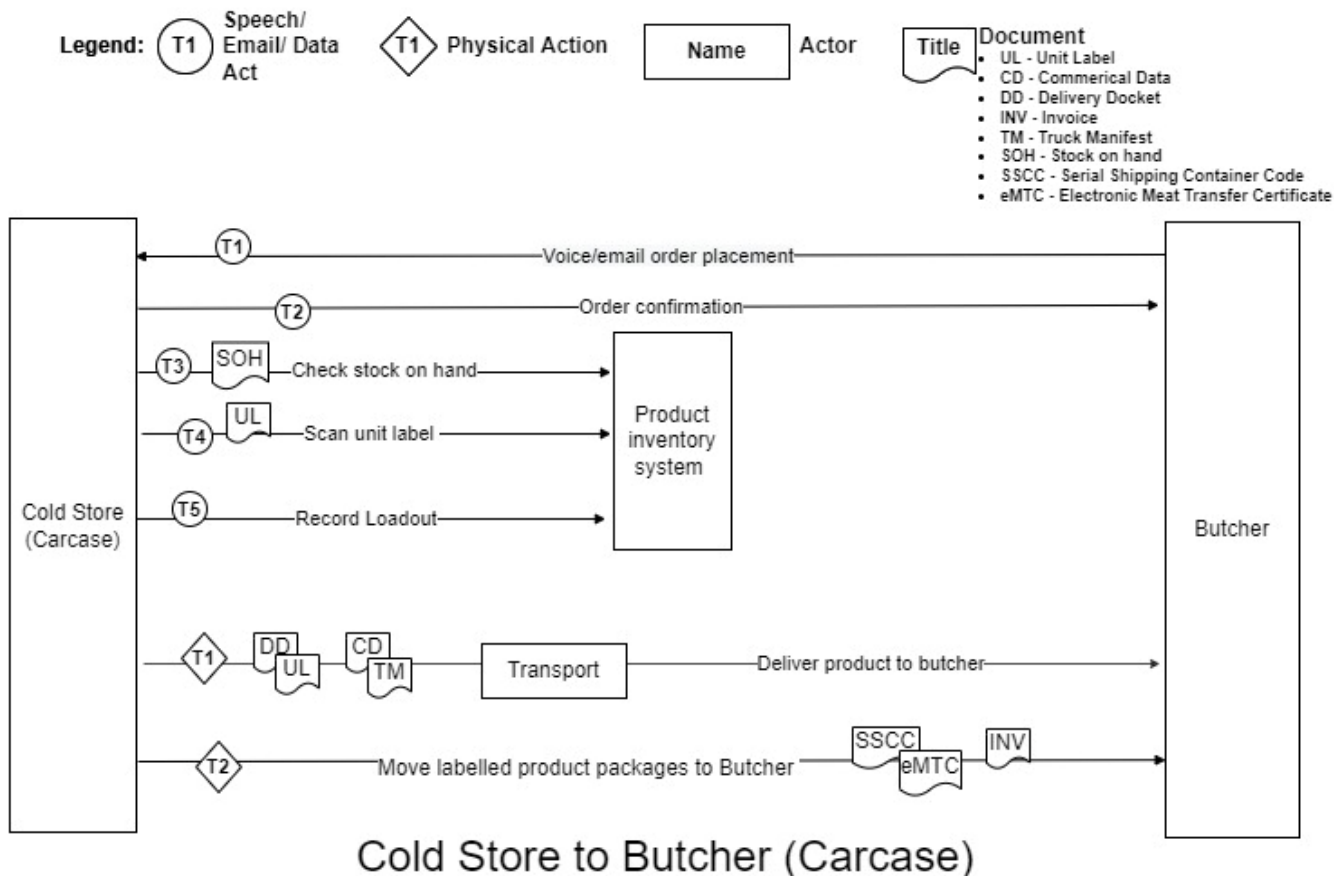

Figure 101. Data or information flows from the cold store (carcase) to butcher in the small stock supply chain.

5.2.3.5.7.2 Cold Store (cartons) to Butcher

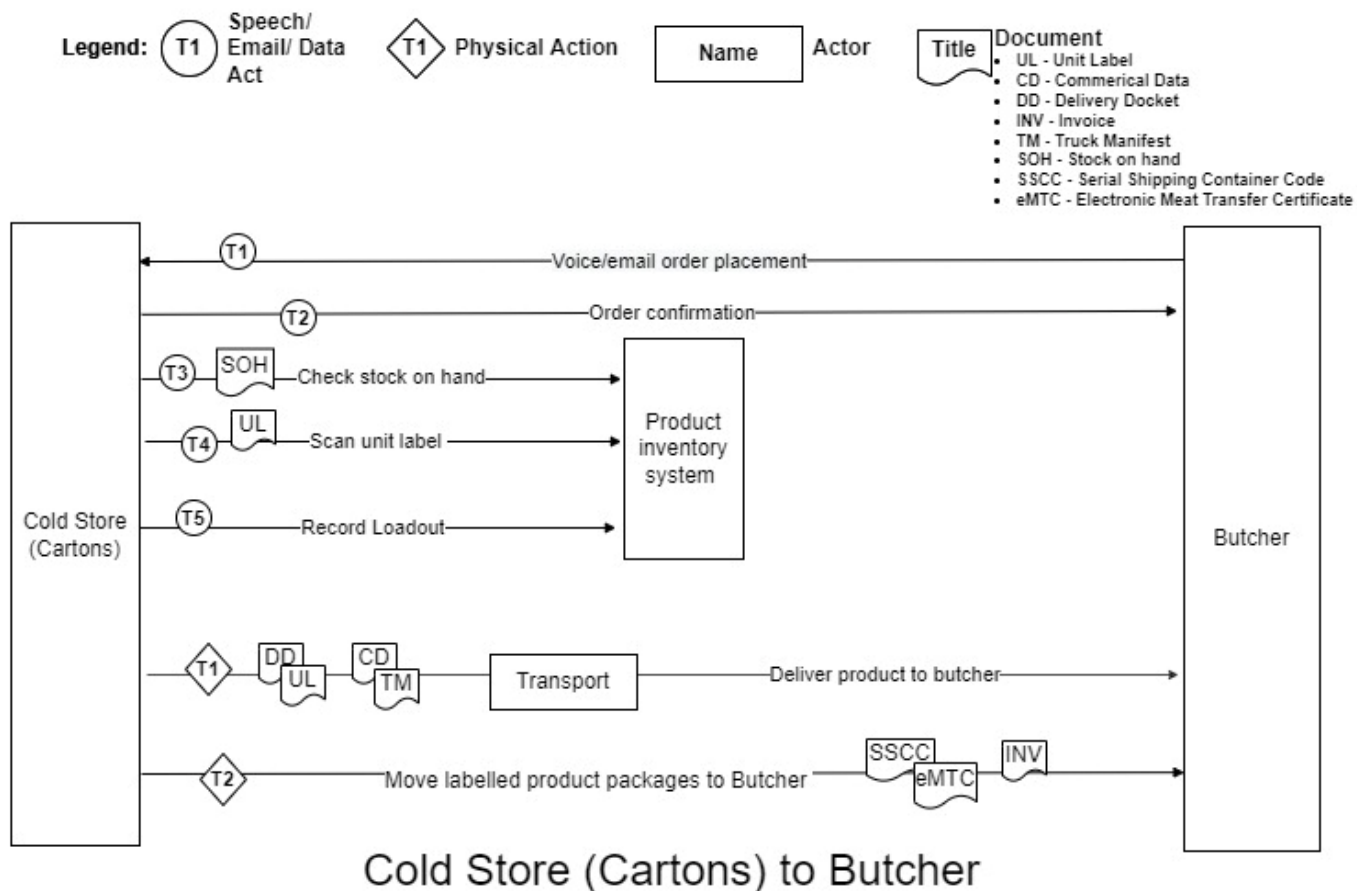

Figure 102. Data or information flows from the cold store (cartons) to butcher in the small stock supply chain.

5.2.3.5.7.3 Independent Boning Room to Butcher

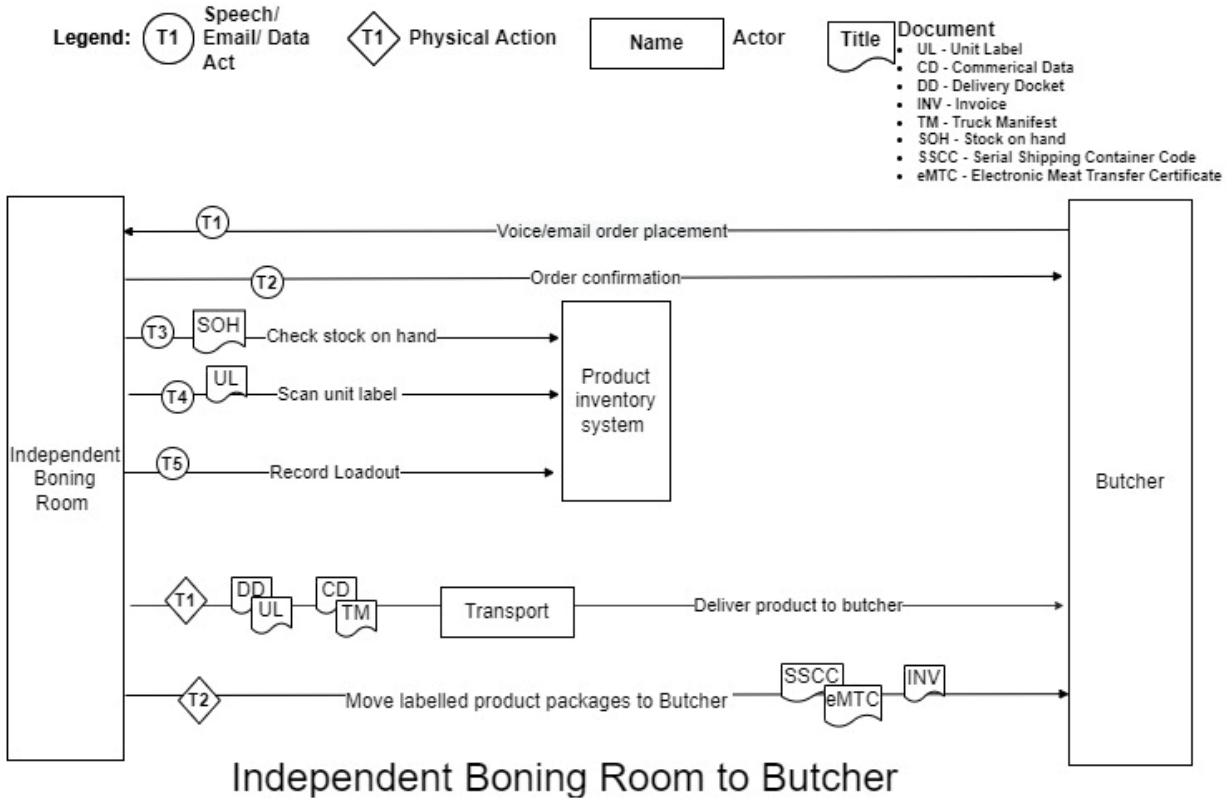

Figure 103. Data or information flows from the independent boning room to butcher in the small stock supply chain.

5.2.3.5.7.4 Third Party Cold Store to Butcher

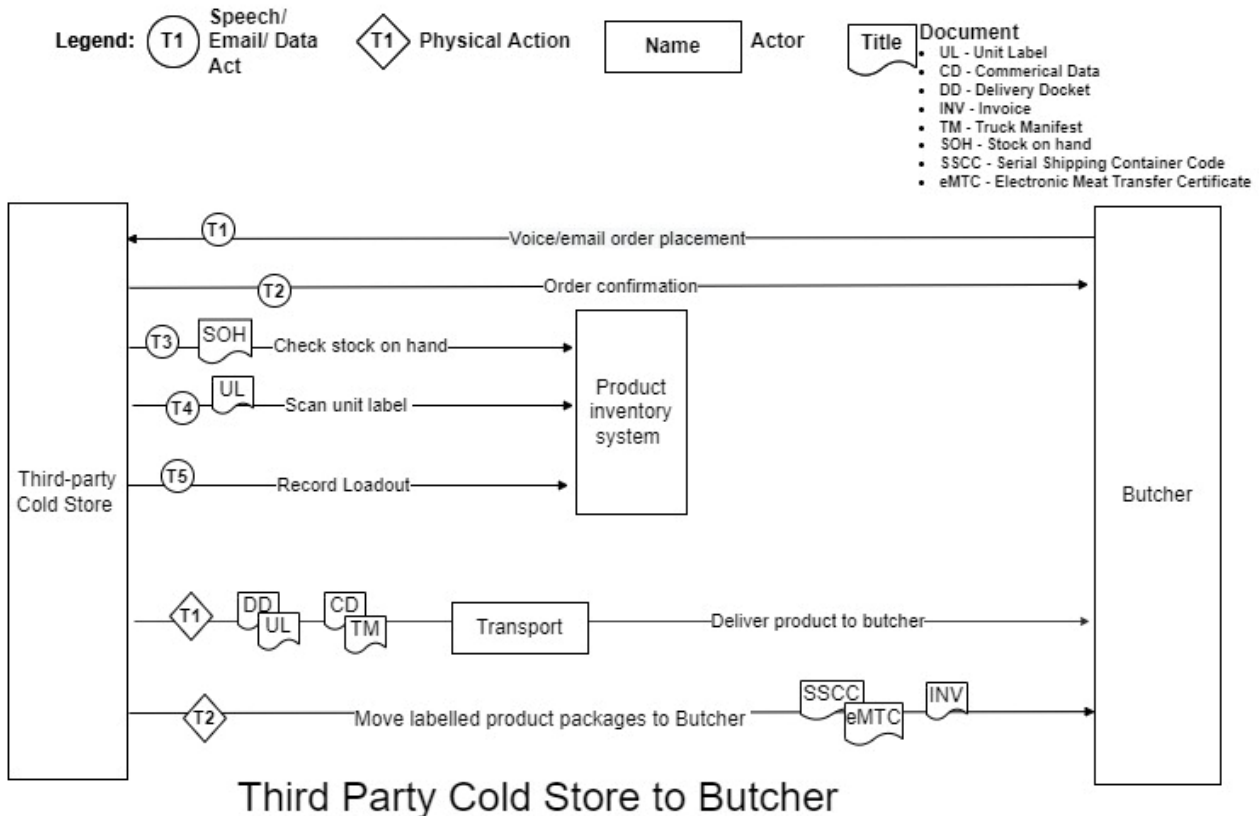

Figure 104. Data or information flows from the third-party cold store to butcher in the small stock supply chain.

5.2.3.5.7.5 Value Added to Butcher

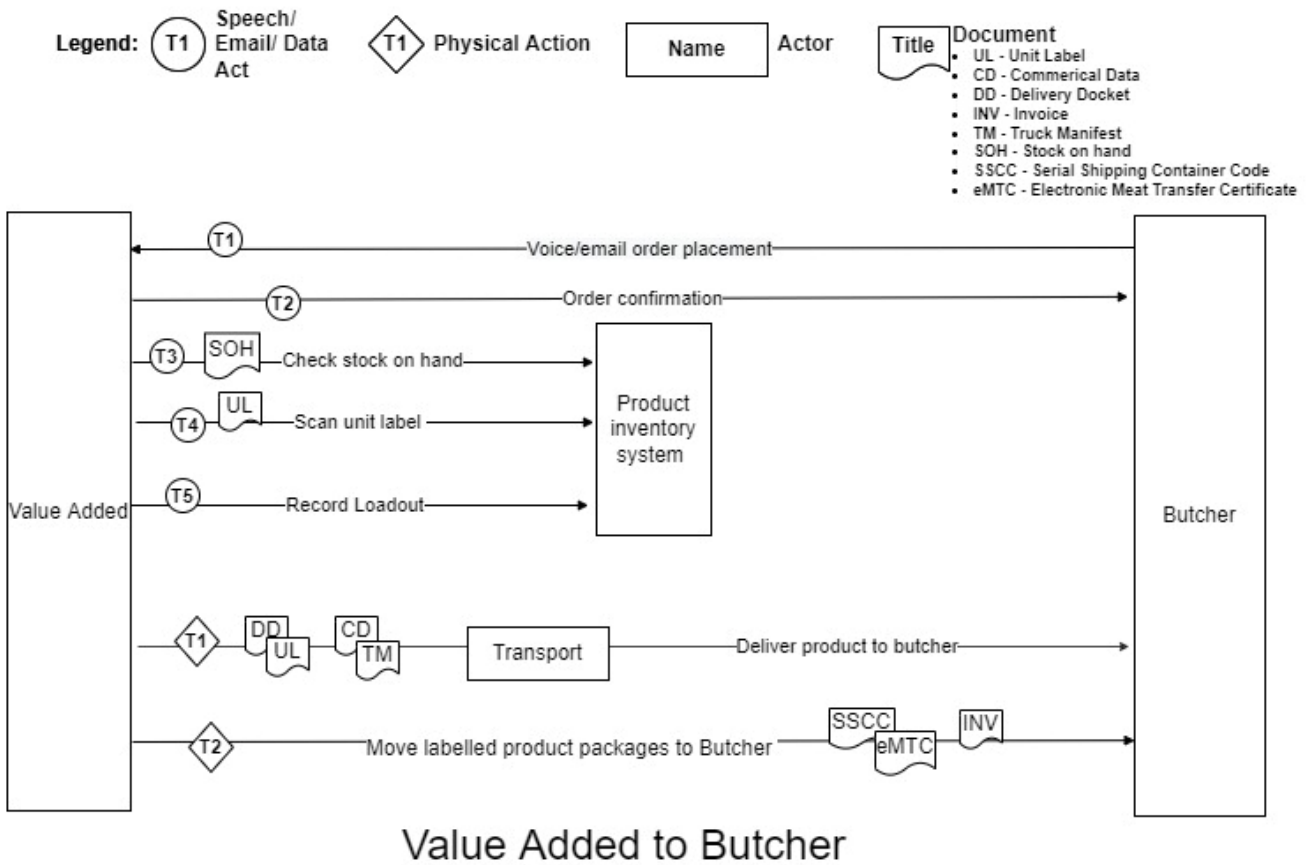

Figure 105. Data or information flows from the value added to butcher in the small stock supply chain.

5.2.3.6 Food services

The food service sector includes those businesses which prepare meat products for consumption outside the home and may include schools, catering, cafes, restaurants, and other eateries. Product may be received in carcase or cartoned form and be sourced directly from the processor cold stores, independent boning room, third-party cold store, or value-adder. After preparation (curing or cooking) meals are purchased by the consumer.

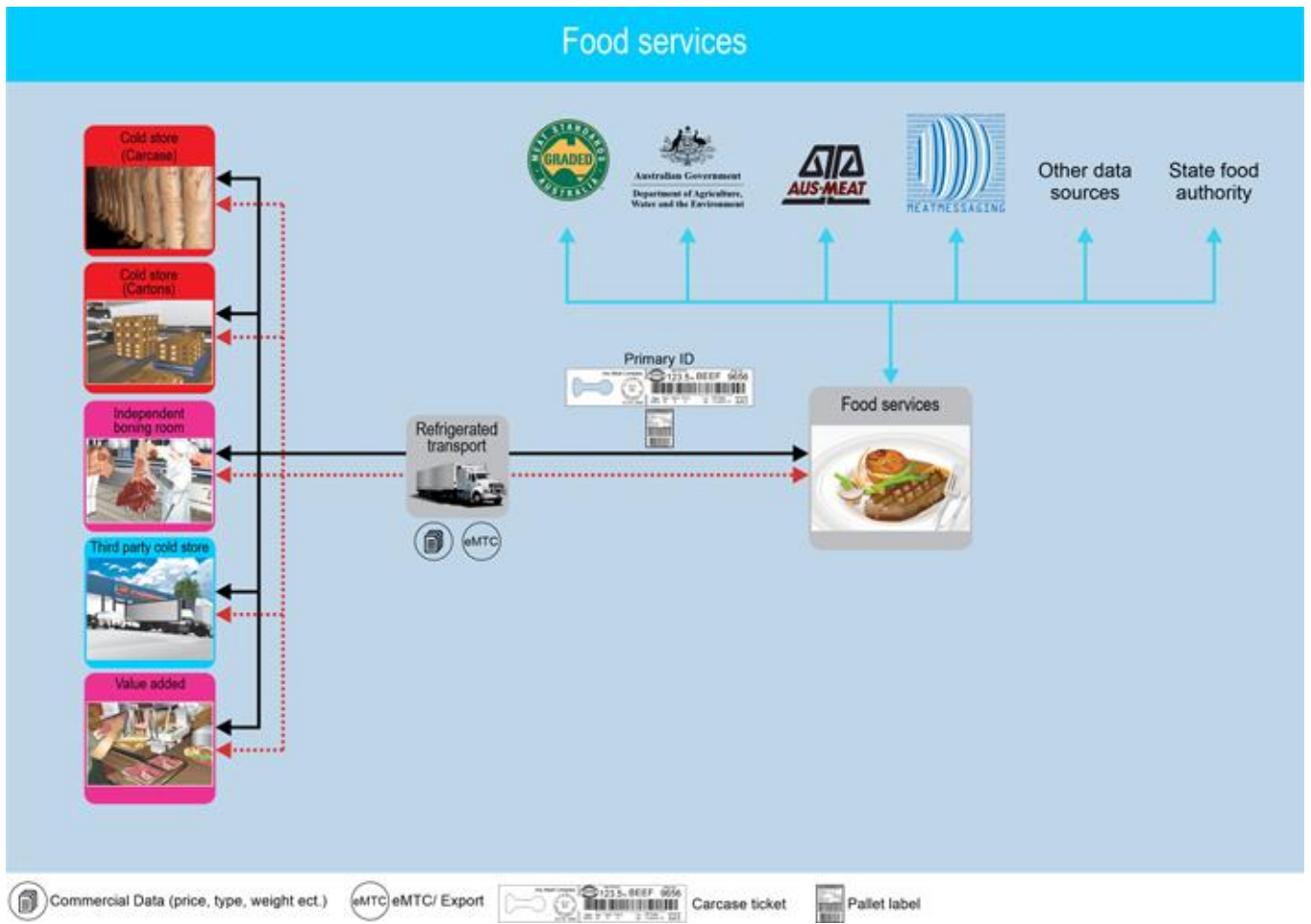

Figure 106. Inputs and outputs of the small stock supply chain food services sector.

5.2.3.6.1 Physical Inputs including Critical Tracking Events (CTEs)

The inputs to the food service system include carcase, carton or palletised product. Critical Tracking Event related documentation for the movement of product into the food service system includes standard movement documentation such as the Delivery Docket/Manifest, Meat Transfer Certificate, carton and pallet labels.

Critical Tracking Events (CTEs) are defined as those events which include the growing, receiving, transforming, creating and shipping of food products. Such events are critical to the traceability of product throughout the supply chain.

The CTEs associated with inputs to the food service system include the receipt of:

- Carcase
- Carton
- Pallet.

Table 85. Physical inputs and associated Critical Tracking Event related documents for a small stock food services system.

Event related to the inputs	Description of the inputs	Critical Tracking Event (CTE) related documents (including electronic)	More details
Carcase	The body of a slaughtered animal after bleeding. Becomes a dressed carcass when hide/skin, head, feet, and offal are removed.	Carcass Ticket, Delivery Docket/Manifest, Meat Transfer Certificate (MTC), MSA Carcass Ticket, Retail production management system, Receipt of purchase/Tax Invoice	
Carton	This is a case, crate, or barrel of product.	Carton label, Delivery Docket/Manifest, Meat Transfer Certificate (MTC), Official seal, Receipt of purchase/Tax Invoice, Retail production management system	
Pallet	A logistic unit which includes a number of cartons or goods items packed together for transport or storage purposes.	Delivery Docket/Manifest, Meat Transfer Certificate (MTC), Receipt of purchase/Tax Invoice, Retail production management system, SSCC/Pallet label	

5.2.3.6.2 Information Inputs including Key Data Elements (KDEs)

Key Data Elements (KDEs) are defined as those elements which are key in identifying and tracing the Critical Tracking Event (CTE). Information inputs or KDEs for the movement of meat product into the food service system can be found on Critical Tracking Event related documentation and is stored in the retailer's production management system.

Table 86. Information inputs, Key Data Elements and Critical Tracking Event related documentation for a small stock food services system.

Attributes (including KDEs)	Description of the Attributes (including KDEs)	Is a KDE	Critical Tracking Event (CTE) related documents (including electronic)	More details
Body number	This is a number assigned to each carcass by the processor for identification purposes.	Yes	Carcass Ticket, Retail production management system	
Company/product code	This is an in-house code for the identification of the product in the unit.	Yes	Carton label, Receipt of purchase/Tax Invoice, Retail production management system, SSCC/Pallet label	
Consignment Serial Shipping Container Code (SSCC)	Encoded in the GS1 barcode, this is a unique number which identifies the individual logistic unit i.e., shipment/message that is assigned by the establishment constructing the unit. The SSCC remains the same for the life of the logistic unit.	Yes	Meat Transfer Certificate (MTC), Retail production management system, SSCC/Pallet label	For more information visit the GS1 website.
Contract number	This is a unique number allocated to the contract by the seller.	Yes	Delivery Docket/Manifest,	

			Retail production management system	
Count of Trade Items	Usually encoded in the GS1 barcode, this is the number of trade items e.g., cartons in the logistic unit.	Yes	Delivery Docket/Manifest, Retail production management system, SSCC/Pallet label	For more information visit the GS1 website.
Date	This is the date of signing or of which a record entry or transaction was made.	Yes	Delivery Docket/Manifest, Meat Transfer Certificate (MTC), Receipt of purchase/Tax Invoice, Retail production management system	
Delivery Docket/Manifest number	This is a unique number allocated to the docket for identification purposes.	Yes	Delivery Docket/Manifest, Retail production management system	
From Establishment number	A number issued by Federal and State Authorities to identify the originating site from which meat or meat products were distributed to domestic or export markets. For transfer certificates, the Establishment numbers for both the dispatching and receiving establishments are recorded.	Yes	Carcase Ticket, Carton label, Delivery Docket/Manifest, Meat Transfer Certificate (MTC), Retail production management system, SSCC/Pallet label	
Global Trade Item Number (GTIN)	Encoded in the GS1 barcode, the GTIN is a globally unique 14-digit number used to identify trade items, products, or services.	Yes	Carcase Ticket, Carton label, Retail production management system, SSCC/Pallet label	For more information visit the GS1 website.
GTIN of Contained Trade Items	Encoded in the GS1 barcode, the GTIN of the contained trade items is a globally unique 14-digit number used to identify trade items, products, or services in the logistic unit.	Yes	Retail production management system, SSCC/Pallet label	For more information visit the GS1 website.
Lot number	A lot is a number assigned by the processor to each group of livestock consigned to slaughter and is usually vendor specific.	Yes	Carcase Ticket, Retail production management system	
Movement date	The date on which livestock or other products (e.g., feed or meat products) were transported between PICs/establishments.	Yes	Delivery Docket/Manifest, Meat Transfer Certificate (MTC), Retail production management system	
MSA eating quality group/grade	This identifies carcasses with similar MSA and eating quality grades, these may align with brands packed by the processor for logistic simplicity. Carcasses are grouped for boning according to eating quality grades.	Yes	MSA Carcase Ticket, Receipt of purchase/Tax Invoice, Retail production management system	For more information on MSA visit the MLA website.

Net Weight (Kilograms)	Usually encoded in the GS1 barcode, the Net Weight is a variable measure of the trade item e.g., carton, pallet or shipment recorded in kilograms.	Yes	Carcase Ticket, Carton label, Retail production management system, SSCC/Pallet label	For more information visit the GS1 website.
Official mark	Any stamp, seal, label, or mark that is declared by the regulations to be an official mark. An official mark signifies that the product has been inspected by and approved as safe for human consumption by an Authorised Officer.	Yes	Carcase Ticket, Carton label, Retail production management system, SSCC/Pallet label	
Order date	This is the date on which the purchase order or contract was raised by the buyer.	Yes	Delivery Docket/Manifest, Retail production management system	
Packaging Date	Encoded in the GS1 barcode, the Packaging Date is the date on which the item was packaged and is recorded in the format year, month, day (YYMMDD).	Yes	Carton label, Retail production management system, SSCC/Pallet label	For more information visit the GS1 website.
Packaging Date Range	This includes the oldest and newest packaging dates for the logistic unit.	Yes	Retail production management system, SSCC/Pallet label	For more information visit the GS1 website.
Pallet Serial Shipping Container Code (SSCC)	Encoded in the GS1 barcode, this is a unique number which identifies the individual logistic unit i.e., pallet that is assigned by the establishment constructing the unit. The SSCC remains the same for the life of the logistic unit.	Yes	Meat Transfer Certificate (MTC), Retail production management system, SSCC/Pallet label	For more information visit the GS1 website.
Production Date (YYMMDD)	Encoded in the GS1 barcode, this is the 'kill' or slaughter' date of the product and is recorded in the format year, month, day (YYMMDD).	Yes	Carcase Ticket, Meat Transfer Certificate (MTC), Retail production management system	For more information visit the GS1 website.
Recipient Australian Business Number (ABN)	This is an 11-digit registration number, issued by the Australian Tax Office, used to identify businesses.	Yes	Receipt of purchase/Tax Invoice, Retail production management system	For more information visit the ATO website.
Seal Serial Number	This is a unique serial number printed on any tamper-evident seal issued by the Department.	Yes	Meat Transfer Certificate (MTC), Official seal, Retail production management system	For more information visit the Australian Government Federal Register of Legislation.
Seller/Supplier Australian Business Number (ABN)	This is an 11-digit registration number, issued by the Australian Tax Office, used to identify businesses.	Yes	Receipt of purchase/Tax Invoice, Retail production management system	For more information visit the ATO website.
Serial Number	Encoded in the GS1 barcode, this is a code, numeric or alphanumeric, assigned to an individual instance of an item for its lifetime.	Yes	Carcase Ticket, Carton label, Retail production management system	For more information visit the GS1 website.
Shipping Mark	Also known as a port mark, this is a code comprising of three letters representing	Yes	Delivery Docket/Manifest,	

	the foreign establishment number and the last nine digits of the consignment SSCC.		Retail production management system, SSCC/Pallet label	
To Establishment number	A number issued by Federal and State Authorities to identify the originating site from which meat or meat products were distributed to domestic or export markets. For transfer certificates, the Establishment numbers for both the dispatching and receiving establishments are recorded.	Yes	Meat Transfer Certificate (MTC), Retail production management system	
Trade description	This is a collective set of words that says what the product is and may include information such as species, net weight of product, name and address of establishments, category ciphers, market endorsements, MSA eating quality etc.	Yes	Carcase Ticket, Carton label, Delivery Docket/Manifest, Meat Transfer Certificate (MTC), Retail production management system, SSCC/Pallet label	
Transfer Certificate number	A unique certificate number issued for traceability purposes.	Yes	Meat Transfer Certificate (MTC), Retail production management system	
Transport registration number	The registration number of the vehicle in which the animals or product were transported. For shipments of product this will be a shipping container number.	Yes	Delivery Docket/Manifest, Meat Transfer Certificate (MTC), Retail production management system	

5.2.3.6.3 Physical Outputs including Critical Tracking Events (CTEs)

Retail-ready meat products are the outputs of the food service system. Being purchased by consumers, CTE documentation may include the product label and receipt of purchase with product exiting the system being recorded in the retailer's production management system.

Critical Tracking Events (CTEs) are defined as those events which include the growing, receiving, transforming, creating, and shipping of food products. Such events are critical to the traceability of product throughout the supply chain.

The CTEs associated with the outputs of the food service system include the movement of:

- Retail Ready Product

off the property, premises, or supply chain sector.

Table 87. Physical outputs and associated Critical Tracking Event related documents for a small stock food services system.

Event related to the inputs	Description of the inputs	Critical Tracking Event (CTE) related documents (including electronic)	More details
Retail Ready Product	These are packaged meat products that are ready to be retailed and purchased by consumers.	Receipt of purchase/Tax Invoice, Retail product label, Retail production management system	

5.2.3.6.4 Information Outputs including Key Data Elements (KDEs)

Key Data Elements (KDEs) are defined as those elements which are key in identifying and tracing the Critical Tracking Event (CTE). Information outputs from the food service system include KDEs which can be drawn from CTE documentation such the product label and receipt of purchase. This may include purchase date, product code and application identifiers on the GS1 barcode.

Table 88. Information outputs, Key Data Elements and Critical Tracking Event related documentation for a small stock food services system.

Attributes (including KDEs)	Description of the Attributes (including KDEs)	Is a KDE	Critical Tracking Event (CTE) related documents (including electronic)	More details
Company/product code	This is an in-house code for the identification of the product in the unit.	Yes	Receipt of purchase/Tax Invoice, Retail production management system	
Date	This is the date of signing or of which a record entry or transaction was made.	Yes	Receipt of purchase/Tax Invoice, Retail production management system	
GS1 compliant numbering and barcode	Numbering and barcode compliant to the GS1 standards and as specified by the contract between the seller and the recipient i.e., retailer.	Yes	Retail product label, Retail production management system	For more information visit the GS1 website.
MSA Licence Number	Any establishment consigning, supplying, or identifying MSA Certified Product must be registered and have a unique MSA Licence Number.	Yes	Receipt of purchase/Tax Invoice, Retail production management system	For more information on MSA visit the MLA website.
Recipient Australian Business Number (ABN)	This is an 11-digit registration number, issued by the Australian Tax Office, used to identify businesses.	Yes	Receipt of purchase/Tax Invoice, Retail production management system	For more information visit the ATO website.
Seller/Supplier Australian Business Number (ABN)	This is an 11-digit registration number, issued by the Australian Tax Office, used to identify businesses.	Yes	Receipt of purchase/Tax Invoice, Retail production management system	For more information visit the ATO website.

5.2.3.6.5 Regulatory and Industry Programs

- Meat Standards Australia (MSA)
- AUS-MEAT
- Australian Meat Industry Council (AMIC)
- Department of Agriculture
- Meat Messaging
- State food authority
- Other data sources

5.2.3.6.6 Supply Chain Node Traceability

The traceability of retail-ready product back to the live animal (depending on the NLIS tag type), or consignment group and property of origin is dependent on the form in which product enters the retail premises. This may include whole carcass, cartoned or palletised form. Further, the level of traceability for each input form is dependent on the packaging processes of the retailer. For example, whole carcass product may or may not be

fully traceable back to the live animal or consignment group. Where this is true, carcasses are broken down into retail cuts on site and may be packaged individually and labelled with a unique, serialised retail label. For this product, traceability back to the live animal or consignment group is possible and can be done by the processing establishment where the animal was slaughtered. Here, carcasses are issued a carcass ticket which correlates to the PIC number or live animal identifier and contains key information, including GS1 meat industry barcode, body number, processing establishment number and production date or 'kill date'. This information is uploaded to the NLIS Database, by the processor, under the processing establishments Property Identification Code (PIC). Thus, there is the potential to trace whole carcasses entering retail premises back to the individual live animal, or consignment group and property of origin. Where carcass retail cuts are not individually packaged or are derived from palletised or cartoned product, retail-ready product may have the same batch traceability limitations as per boning room and value-added product. Please refer to Boning room and Value Added 'Supply Chain Node Traceability' for more information.

5.2.3.6.7 Data flow diagrams

Direction	Description
Output	Cold Store (carcass) to Food Services
Output	Cold Store (cartons) to Food Services
Output	Independent Boning Room to Food Services
Output	Third Party Cold Store to Food Services
Output	Value Added to Food Services

5.2.3.6.7.1 Cold Store (carcase) to Food Services

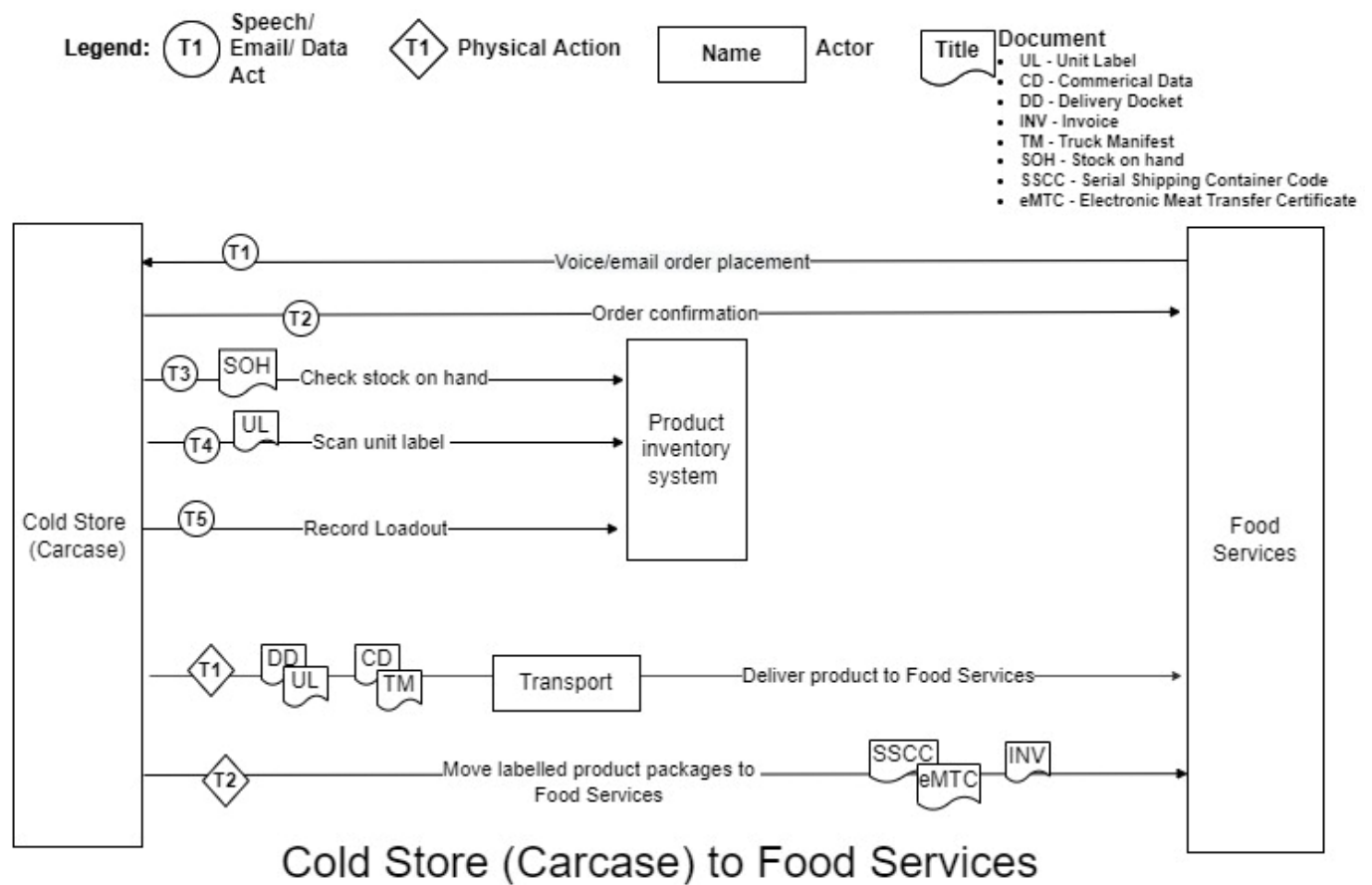

Figure 107. Data or information flows from the cold store (carcase) to food services in the small stock supply chain.

5.2.3.6.7.2 Cold Store (cartons) to Food Services

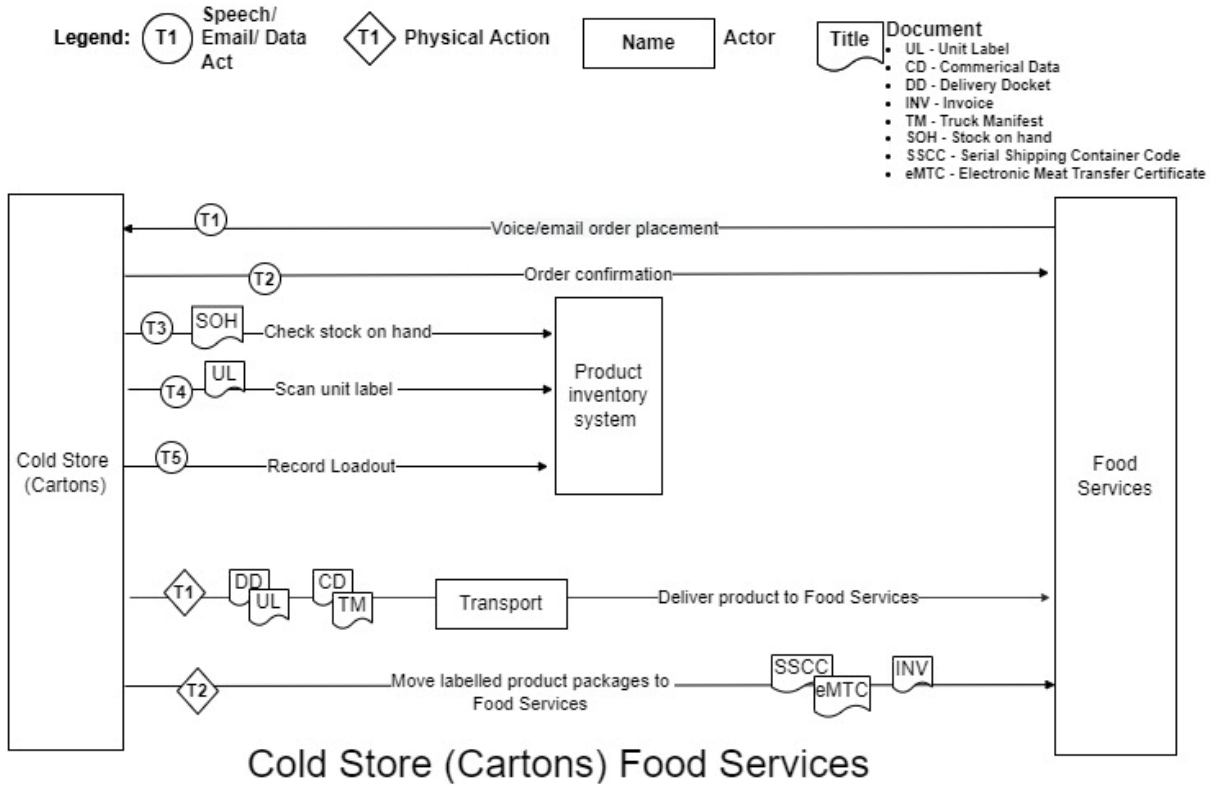

Figure 108. Data or information flows from the cold store (cartons) to food services in the small stock supply chain.

5.2.3.6.7.3 Independent Boning Room to Food Services

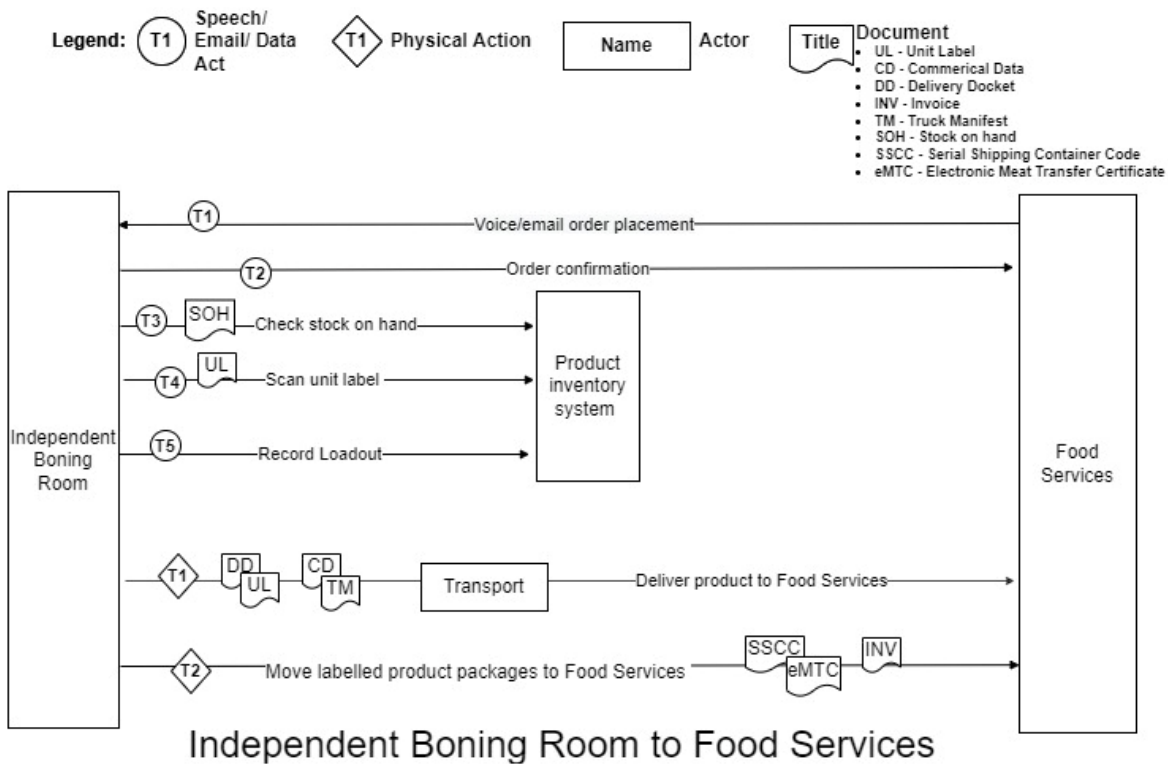

Figure 109. Data or information flows from the independent boning room to food services in the small stock supply chain.

5.2.3.6.7.4 Third Party Cold Store to Food Services

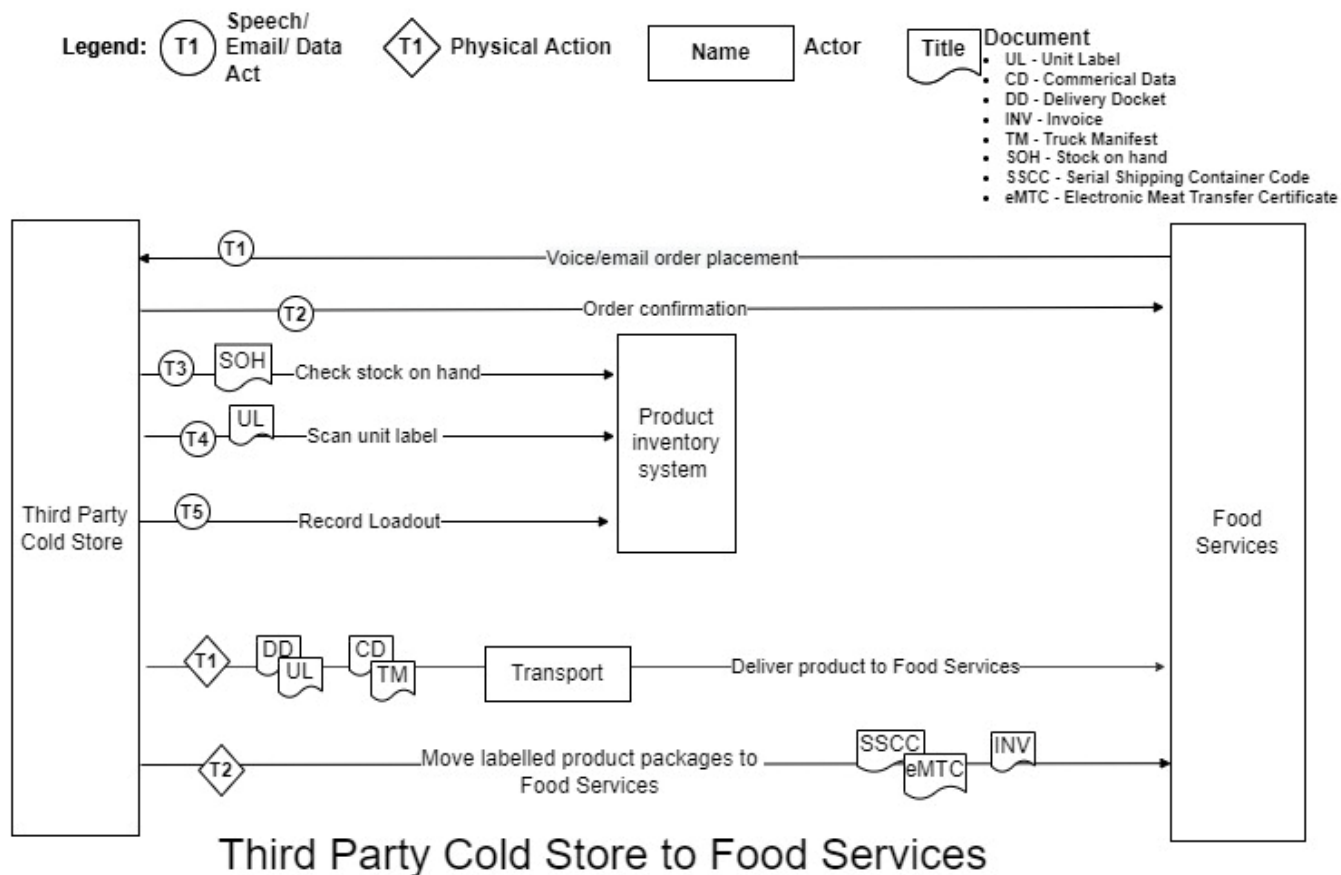

Figure 110. Data or information flows from the third-party cold store to food services in the small stock supply chain.

5.2.3.6.7.5 Value Added to Food Services

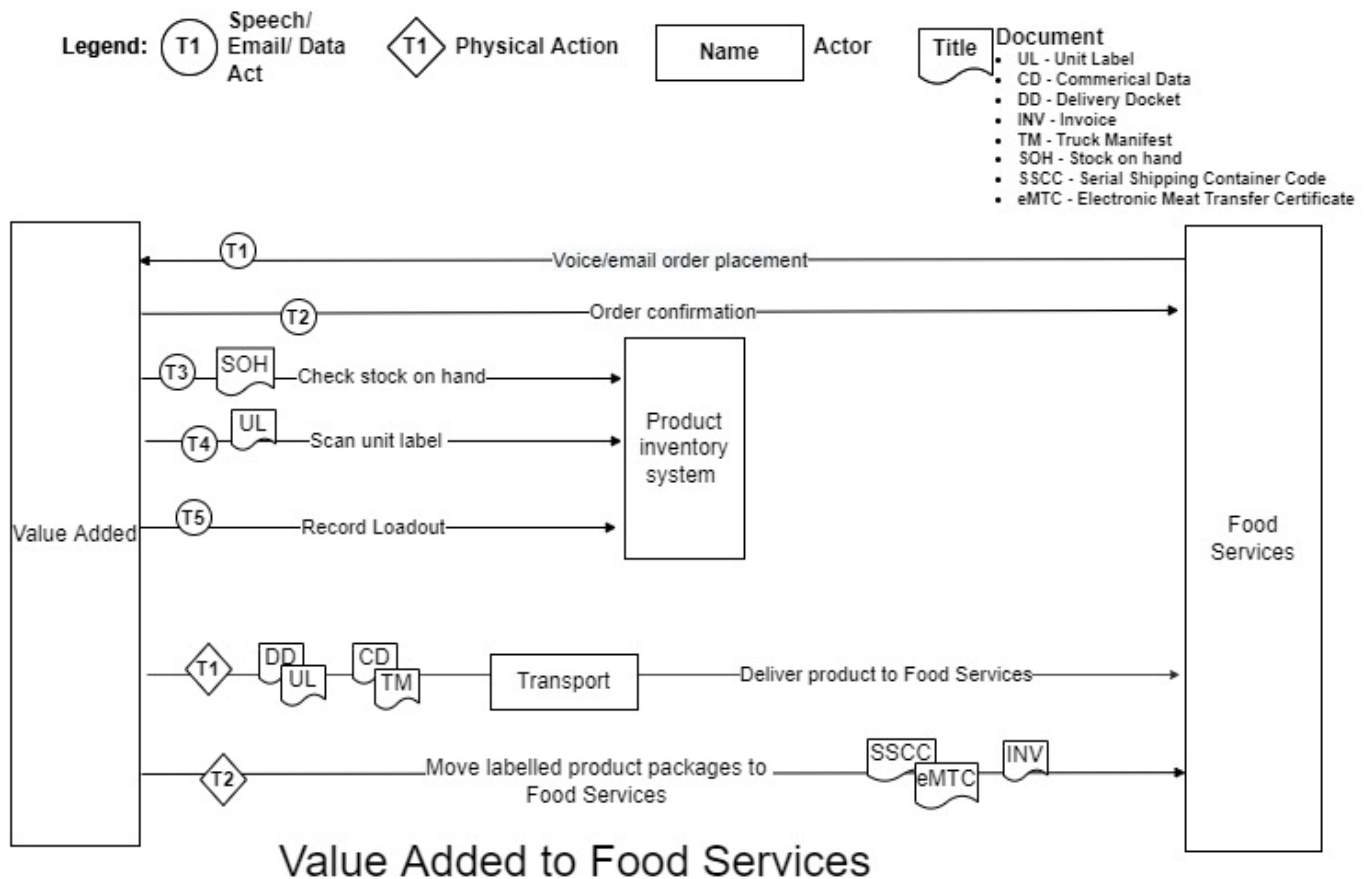

Figure 111. Data or information flows from the value added to food services in the small stock supply chain.

5.2.4 Exporting Country - Cross-sector

5.2.4.1 Livestock transport

Livestock transport is the process whereby animals are moved from one property to another by a mode of transport, most commonly truck. This journey requires careful preparation to ensure that animal stress as well as any risks to welfare are minimised. The Australian Animal Welfare Standards and Guidelines, Land Transport and Livestock outline the transportation requirements for livestock movement and are regulated by State legislation. General guidelines state that the livestock should be fit for transport; handled correctly by professionals; that transportation facilities are adequate for the transfer of livestock; that the journey is planned to ensure delivery at the correct time; and that the livestock are cared for, protected, treated for any injury or disease, and supplied adequate feed, water, and shelter for the duration of the transport.

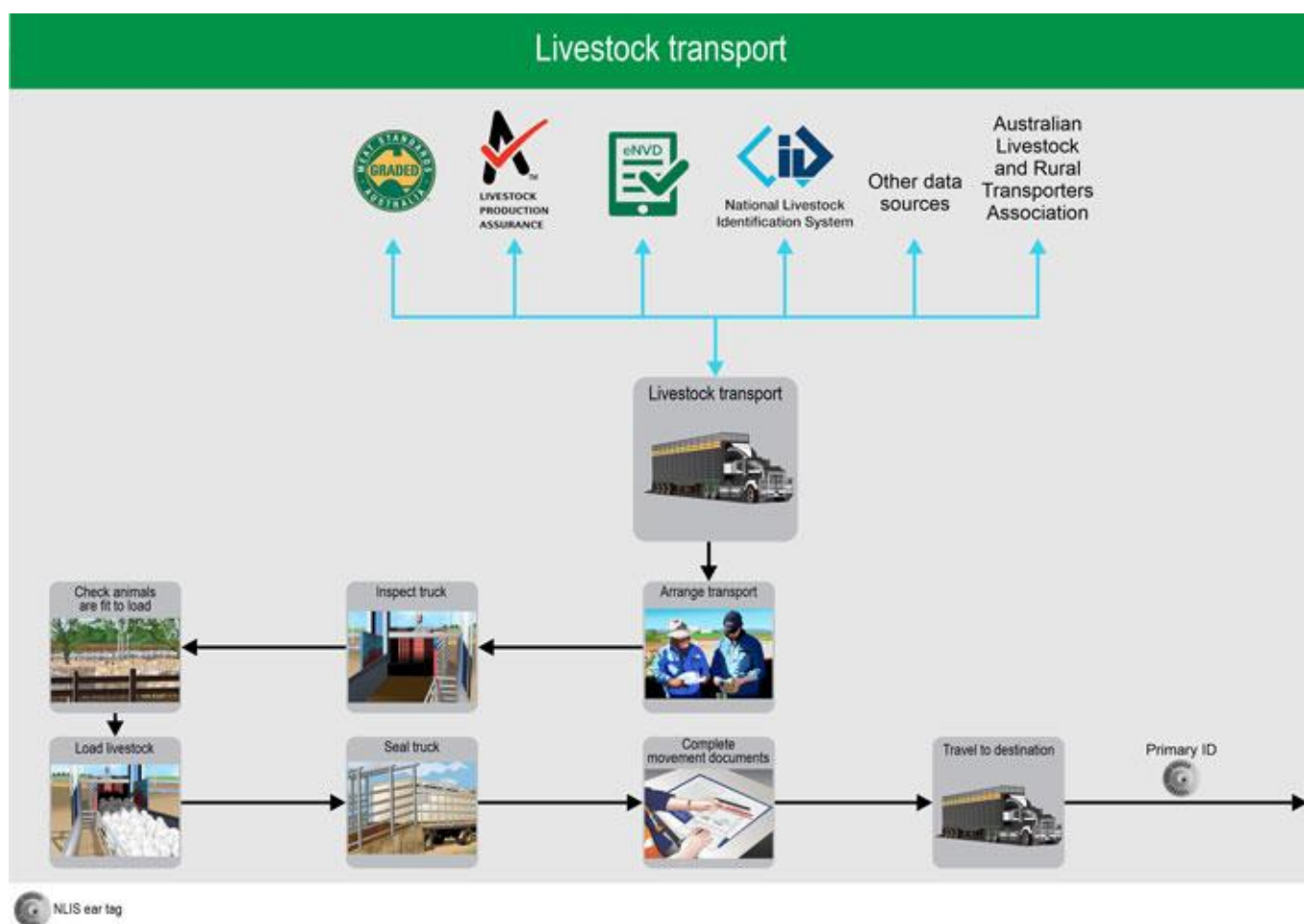

Figure 112. Inputs and outputs of the small stock supply chain livestock transport sector.

5.2.4.1.1 Physical Inputs including Critical Tracking Events (CTEs)

There are few physical inputs for the transportation of livestock. Inputs not only include the livestock, but those materials required to ensure that animal welfare standards and guidelines are met whilst livestock are in transit.

Critical Tracking Events (CTEs) are defined as those events which include the growing, receiving, transforming, creating and shipping of food products. Such events are critical to the traceability of product throughout the supply chain.

The CTEs associated with inputs to the livestock transport system include the receipt of:

- Small livestock
- Feed supplies and supplements
- NLIS ID tags.

Table 89. Physical inputs and associated Critical Tracking Event related documents for a small stock livestock transport system.

Event related to the inputs	Description of the inputs	Critical Tracking Event (CTE) related documents (including electronic)	More details
Small livestock	These are sheep or goat livestock and may include any class of animals e.g., weaners, ewe/nanny, ram/buck, cull livestock etc.	Commercial supply contract, Feed and water record, MSA Declaration, NFAS Agents Declaration, NFAS Delivery	

		Docket or Form B, NLIS Movement Update, NVD, Post Sale Summary, Receipt of purchase/Tax Invoice, State specific movement forms	
Feed supplies and supplements	These are supplementary animal feed products such as hay or silage fodder, or mineral supplements which are provided to ensure the production efficiency and health of livestock are maintained. This may also include clean drinking water e.g., where livestock are in transit or at saleyards.	Commodity Vendor Declaration (CVD), Receipt of purchase/Tax Invoice	
NLIS ID tags	These are animal identification tags with a unique number which must be attached to animal moved off a PIC for traceability purposes.	NLIS Movement Update	

5.2.4.1.2 Information Inputs including Key Data Elements (KDEs)

Key Data Elements (KDEs) are defined as those elements which are key in identifying and tracing the Critical Tracking Event (CTE). Information inputs for the movement of small livestock are those related to the CTE documents and ensuring the health and welfare of the livestock themselves.

Table 90. Information inputs, Key Data Elements and Critical Tracking Event related documentation for a small stock livestock transport system.

Attributes (including KDEs)	Description of the Attributes (including KDEs)	Is a KDE	Critical Tracking Event (CTE) related documents (including electronic)	More details
Agreement date	This is the date on which an agreement between two parties was made.	Yes	Commercial supply contract	
APVMA approval number	This is a unique number allocated to each label by the APVMA.	Yes	Commodity Vendor Declaration, NVD	For more information visit the Australian Pesticides and Veterinary Medicine Authority.
Batch number	This is a unique number which identifies products sharing certain production characteristics and is used for traceability purposes.	Yes	Commodity Vendor Declaration, NVD	
Company/product code	This is an in-house code for the identification of the product in the unit.	Yes	Feed and water record, Receipt of purchase/Tax Invoice	
Contract number	This is a unique number allocated to the contract by the seller.	Yes	Commercial supply contract, Commodity Vendor Declaration	

Date	This is the date of signing or of which a record entry or transaction was made.	Yes	Commercial supply contract, Commodity Vendor Declaration, Feed and water record, MSA Declaration, NFAS Agents Declaration, NFAS Delivery Docket or Form B, NVD, Post Sale Summary, Receipt of purchase/Tax Invoice, State specific movement forms	
From PIC	The Property Identification Code from/to where the livestock or product were consigned.	Yes	Commodity Vendor Declaration, MSA Declaration, NFAS Delivery Docket or Form B, NLIS Movement Update, NVD, Post Sale Summary, State specific movement forms	For more information visit the Integrity systems website.
Movement date	The date on which livestock or other products (e.g., feed or meat products) were transported between PICs/establishments.	Yes	Commercial supply contract, Commodity Vendor Declaration, MSA Declaration, NFAS Agents Declaration, NFAS Delivery Docket or Form B, NLIS Movement Update, NVD, State specific movement forms	
Movement time	This is the time at which small livestock were moved from the property (PIC) of origin. Direct consignments travelling to processors by road must be slaughtered with 48 hours of dispatch.	Yes	MSA Declaration	
MSA Declaration Serial Number	Each MSA Declaration form has a unique serial number.	Yes	MSA Declaration	For more information on MSA visit the MLA website.
MSA Licence Number	Any establishment consigning, supplying or identifying MSA Certified Product must be registered and have a unique MSA Licence Number.	Yes	MSA Declaration, Receipt of purchase/Tax Invoice	For more information on MSA visit the MLA website.
National Grower Registration Number	A unique number assigned to individuals registered with the National Grower Register, an online business register for Australian growers.	Yes	Commodity Vendor Declaration	
NFAS Accreditation Number	This is a unique number given to accredited feedlots certified under the National Feedlot Accreditation Scheme (NFAS).	Yes	NFAS Delivery Docket or Form B	For more information visit the AUS-MEAT website.

NFAS Delivery Docket Number	Each NFAS document has a unique number or identity code.	Yes	NFAS Agents Declaration	For more information visit the AUS-MEAT website.
NLIS Tag Number/RFID	All animals transported between PICs must have a permanent National Livestock Identification System tag attached. This tag has a unique animal identification number.	Yes	NLIS Movement Update	For more information visit the Integrity systems website.
NVD Serial Number	Each NVD form has a unique serial number.	Yes	NFAS Delivery Docket or Form B, NLIS Movement Update, NVD, Post Sale Summary	For more information visit the Integrity systems website.
Producer/Vendor MSA Registration Number	Producers consigning small livestock to MSA markets are required to be registered and have a unique MSA Registration Number.	Yes	MSA Declaration	For more information on MSA visit the MLA website.
Product code/description	This is a unique identifier or description assigned by the seller to each product type marketed or for sale.	Yes	Commodity Vendor Declaration	
Quality Assurance Officer (QAO) Certificate Number	A unique number issued to personnel issued with a Statement of Authority for demonstrating skills for compliance with meeting NFAS Rules and Standards.	Yes	NFAS Delivery Docket or Form B	For more information visit the AUS-MEAT website.
Recipient Australian Business Number (ABN)	This is an 11-digit registration number, issued by the Australian Tax Office, used to identify businesses.	Yes	Feed and water record, Receipt of purchase/Tax Invoice	For more information visit the ATO website.
Seller/Supplier Australian Business Number (ABN)	This is an 11-digit registration number, issued by the Australian Tax Office, used to identify businesses.	Yes	Feed and water record, Receipt of purchase/Tax Invoice	For more information visit the ATO website.
To PIC	The Property Identification Code from/to where the livestock or product were consigned.	Yes	Commodity Vendor Declaration, NLIS Movement Update, NVD, Post Sale Summary, State specific movement forms	For more information visit the Integrity systems website.
Transport registration number	The registration number of the vehicle in which the animals or product were transported. For shipments of product this will be a shipping container number.	Yes	NVD	

Treatment date	The date on which a treatment or product was applied to a unit e.g., paddock, animal, fodder etc.	Yes	Commodity Vendor Declaration, Feed and water record, NVD	
----------------	---	-----	--	--

5.2.4.1.3 Physical Outputs including Critical Tracking Events (CTEs)

Physical outputs for the transportation of small livestock are limited to the livestock themselves.

Critical Tracking Events (CTEs) are defined as those events which include the growing, receiving, transforming, creating, and shipping of food products. Such events are critical to the traceability of product throughout the supply chain.

The CTEs associated with the outputs of the livestock transport system include the movement of:

- Small livestock

off the property, premises, or supply chain sector.

Table 91. Physical outputs and associated Critical Tracking Event related documents for a small stock livestock transport system.

Event related to the inputs	Description of the inputs	Critical Tracking Event (CTE) related documents (including electronic)	More details
Small livestock	These are sheep or goat livestock and may include any class of animals e.g., weaners, ewe/nanny, ram/buck, cull livestock etc.	Commercial supply contract, Feed and water record, MSA Declaration, NFAS Agents Declaration, NFAS Delivery Docket or Form B, NLIS Movement Update, NVD, Post Sale Summary, Receipt of purchase/Tax Invoice, State specific movement forms	

5.2.4.1.4 Information Outputs including Key Data Elements (KDEs)

Key Data Elements (KDEs) are defined as those elements which are key in identifying and tracing the Critical Tracking Event (CTE). Information outputs related to livestock transport include that pertaining to the livestock themselves such as the NLIS ID tag number and any information to be passed on from feed and water records, as well as all other documents critical to the traceability of livestock movements.

Table 92. Information inputs, Key Data Elements and Critical Tracking Event related documentation for a small stock livestock transport system.

Attributes (including KDEs)	Description of the Attributes (including KDEs)	Is a KDE	Critical Tracking Event (CTE) related documents (including electronic)	More details
Agreement date	This is the date on which an agreement between two parties was made.	Yes	Commercial supply contract	
APVMA approval number	This is a unique number allocated to each label by the APVMA.	Yes	NVD	For more information visit the Australian Pesticides and

				Veterinary Medicine Authority.
Batch number	This is a unique number which identifies products sharing certain production characteristics and is used for traceability purposes.	Yes	NVD	
Company/product code	This is an in-house code for the identification of the product in the unit.	Yes	Feed and water record, Receipt of purchase/Tax Invoice	
Contract number	This is a unique number allocated to the contract by the seller.	Yes	Commercial supply contract	
Date	This is the date of signing or of which a record entry or transaction was made.	Yes	Commercial supply contract, Feed and water record, MSA Declaration, NFAS Agents Declaration, NFAS Delivery Docket or Form B, NVD, Post Sale Summary, Receipt of purchase/Tax Invoice, State specific movement forms	
From PIC	The Property Identification Code from/to where the livestock or product were consigned.	Yes	MSA Declaration, NFAS Delivery Docket or Form B, NLIS Movement Update, NVD, Post Sale Summary, State specific movement forms	For more information visit the Integrity systems website.
Movement date	The date on which livestock or other products (e.g., feed or meat products) were transported between PICs/establishments.	Yes	Commercial supply contract, MSA Declaration, NFAS Agents Declaration, NFAS Delivery Docket or Form B, NLIS Movement Update, NVD, State specific movement forms	
Movement time	This is the time at which livestock were moved from the property (PIC) of origin. Direct consignments travelling to processors by road must be slaughtered with 48 hours of dispatch.	Yes	MSA Declaration	
MSA Declaration Serial Number	Each MSA Declaration form has a unique serial number.	Yes	MSA Declaration	For more information on MSA visit the MLA website.
MSA Licence Number	Any establishment consigning, supplying, or identifying MSA Certified Product must be registered and have a unique MSA Licence Number.	Yes	MSA Declaration, Receipt of purchase/Tax Invoice	For more information on MSA visit the MLA website.

NFAS Accreditation Number	This is a unique number given to accredited feedlots certified under the National Feedlot Accreditation Scheme (NFAS).	Yes	NFAS Delivery Docket or Form B	For more information visit the AUS-MEAT website.
NFAS Delivery Docket Number	Each NFAS document has a unique number or identity code.	Yes	NFAS Agents Declaration	For more information visit the AUS-MEAT website.
NLIS Tag Number/RFID	All animals transported between PICs must have a permanent National Livestock Identification System tag attached. This tag has a unique animal identification number.	Yes	NLIS Movement Update	For more information visit the Integrity systems website.
NVD Serial Number	Each NVD form has a unique serial number.	Yes	NFAS Delivery Docket or Form B, NLIS Movement Update, NVD, Post Sale Summary	For more information visit the Integrity systems website.
Producer/Vendor MSA Registration Number	Producers consigning livestock to MSA markets are required to be registered and have a unique MSA Registration Number.	Yes	MSA Declaration	For more information on MSA visit the MLA website.
Quality Assurance Officer (QAO) Certificate Number	A unique number issued to personnel issued with a Statement of Authority for demonstrating skills for compliance with meeting NFAS Rules and Standards.	Yes	NFAS Delivery Docket or Form B	For more information visit the AUS-MEAT website.
Recipient Australian Business Number (ABN)	This is an 11-digit registration number, issued by the Australian Tax Office, used to identify businesses.	Yes	Feed and water record, Receipt of purchase/Tax Invoice	For more information visit the ATO website.
Seller/Supplier Australian Business Number (ABN)	This is an 11-digit registration number, issued by the Australian Tax Office, used to identify businesses.	Yes	Feed and water record, Receipt of purchase/Tax Invoice	For more information visit the ATO website.
To PIC	The Property Identification Code from/to where the livestock or product were consigned.	Yes	NLIS Movement Update, NVD, Post Sale Summary, State specific movement forms	For more information visit the Integrity systems website.
Transport registration number	The registration number of the vehicle in which the animals or product were transported. For shipments of product this will be a shipping container number.	Yes	NVD	

Treatment date	The date on which a treatment or product was applied to a unit e.g., paddock, animal, fodder etc.	Yes	Feed and water record, NVD	
----------------	---	-----	----------------------------	--

5.2.4.1.5 Regulatory and Industry Programs

- Australian Livestock and Rural Transporters Association (ALRTA)
- eNVD
- Livestock Production Assurance (LPA)
- Meat Standards Australia (MSA)
- National Livestock Identification System (NLIS)
- Other data sources

5.2.4.1.6 Supply Chain Node Traceability

The National Livestock Identification System (NLIS) is the Australian livestock traceability program which is administered by Integrity Systems Company (ISC). Where stipulated by State legislation and certain export markets, the NLIS system requires all animals bought, sold, and moved along the supply chain to be tagged with an accredited NLIS ID tag. Each tag has an NLIS tag number or Radio Frequency Identifier (RFID) for the traceability of the animal throughout its lifetime. Every property which holds livestock must have a Property Identification Code (PIC) to which the livestock are assigned in the NLIS Database. Each time livestock are transferred between PICs within Australia they must be accompanied by a livestock movement declaration, such as the National Vendor Declaration (NVD) form. This document typically outlines the transporter details, consignment details, compliance with intended market specifications, withholding periods, and the details of the new property PIC. All livestock movements between PICs require an NLIS movement update to be made by either or both the consigner and receiver. Where NLIS ID tags are lost livestock must be issued with a new post-breeder tag if not on the PIC of birth and this reconciled in the NLIS Database.

5.2.4.1.7 Data flow diagrams

Table 93. Data flow diagrams for the inputs and outputs of a small stock livestock transport system.

Direction	Description
Input	Instruction to move livestock
Output	Details of movement of livestock

5.2.4.1.7.1 Instruction to move livestock

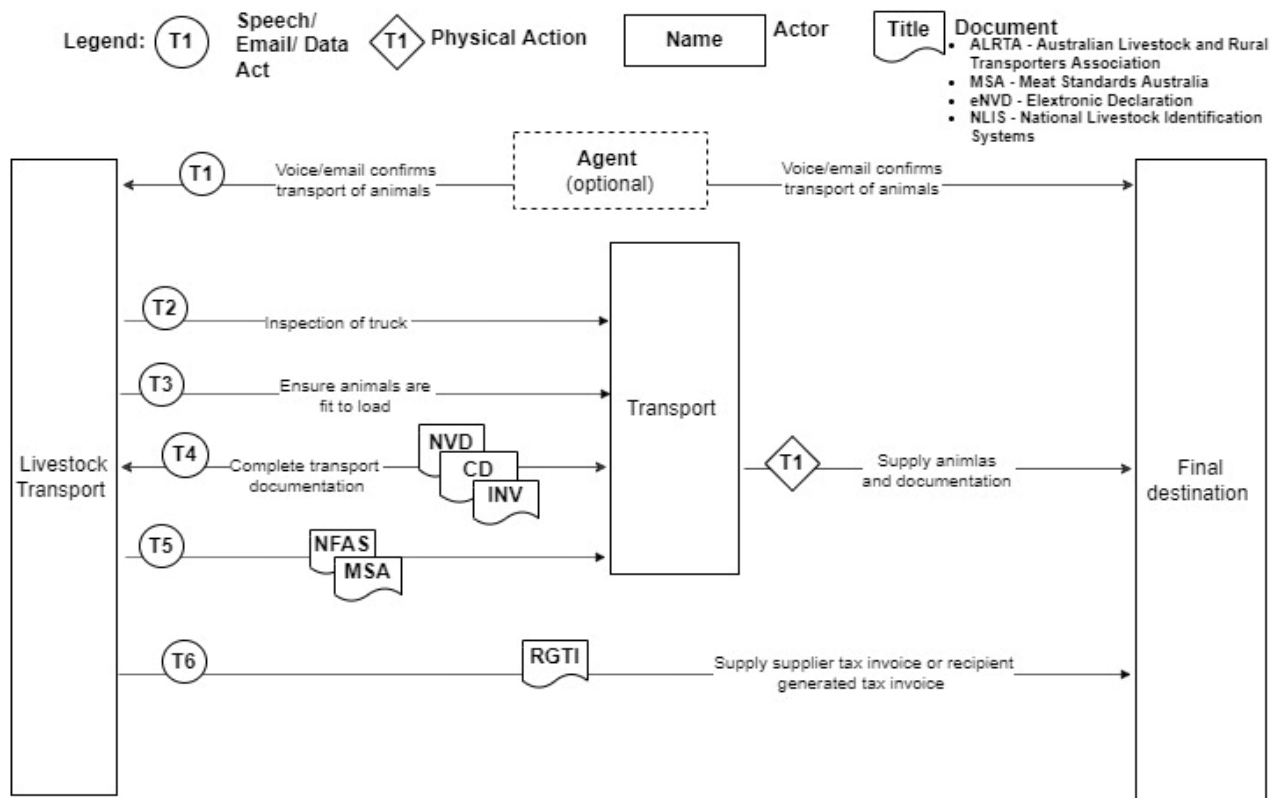

Livestock Transport

Figure 113. Data or information flows from the instruction to move livestock in the small stock supply chain.

5.2.4.1.7.2 Details of movement of livestock

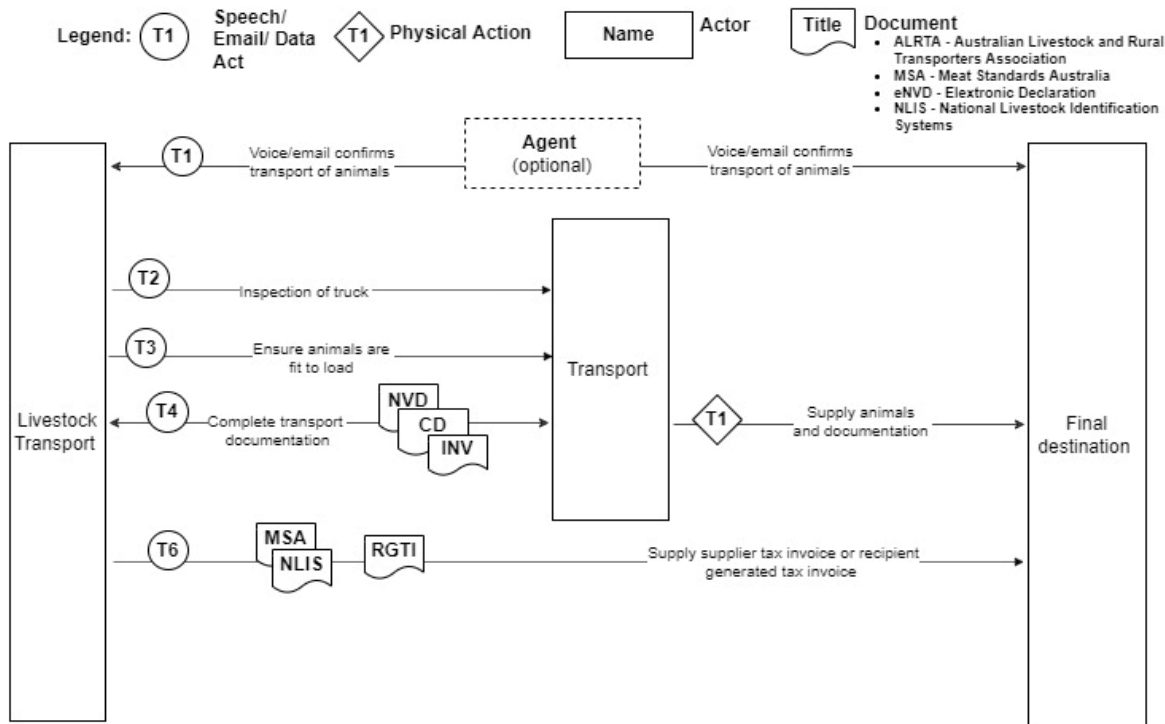

Movement of Livestock

Figure 114. Data or information flows from the movement of livestock in the small stock supply chain.

5.2.4.2 Refrigerated transport

Refrigerated transport involves the movement (including loading and unloading) of meat and meat products from one premises to another under conditions that ensure that product integrity and wholesomeness are maintained. Ensuring that adequate hygiene and temperature controls are complied with is integral to successful refrigerated transport. Product may be in carcase, cartoned, or palletised form and must be accompanied by Critical Tracking Event related documents such as the Meat Transfer Certificate (MTC).

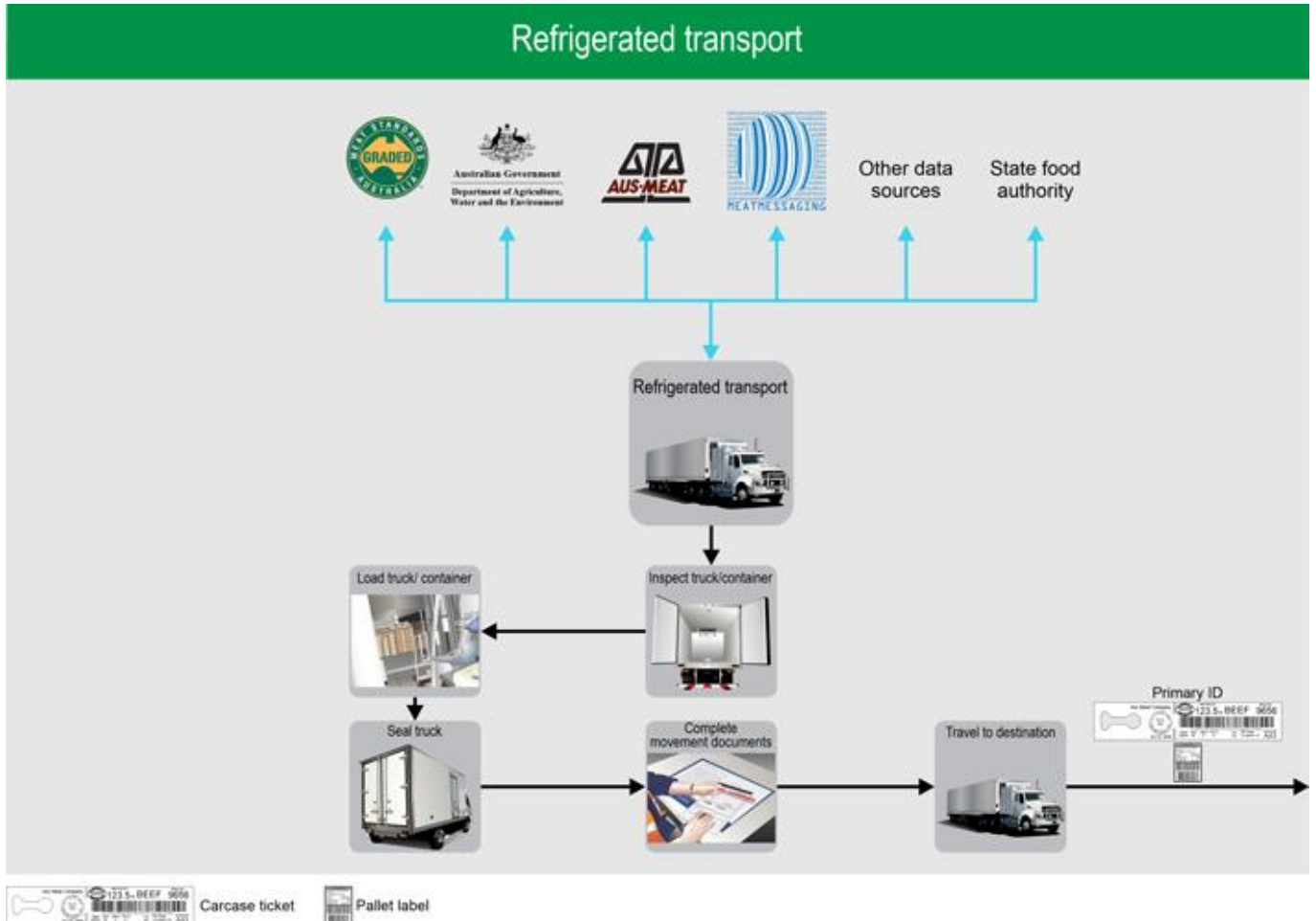

Figure 115. Inputs and outputs of the small stock supply chain refrigerated transport sector.

5.2.4.2.1 Physical Inputs including Critical Tracking Events (CTEs)

Meat and meat products may be transported between various establishments such as cold stores, independent boning rooms, value adding facilities and retailing premises, as well as to exporting facilities. Therefore, the physical inputs to the refrigerated transport process may take various forms including product in carcase, carton or palletised form or product packed into shipping containers ready for export.

Critical Tracking Events (CTEs) are defined as those events which include the growing, receiving, transforming, creating and shipping of food products. Such events are critical to the traceability of product throughout the supply chain.

The CTEs associated with inputs to the refrigerated transport system include the receipt of:

- Carcase
- Carton
- Pallet

- Container System Unit (meat and meat products).

Table 94. Physical inputs and associated Critical Tracking Event related documents for a small stock refrigerated transport system.

Event related to the inputs	Description of the inputs	Critical Tracking Event (CTE) related documents (including electronic)	More details
Carcase	The body of a slaughtered animal after bleeding. Becomes a dressed carcase when hide, head, feet and offal are removed.	Carcase Ticket, Delivery Docket/Manifest, Meat Transfer Certificate (MTC), MSA Carcase Ticket, Receipt of purchase/Tax Invoice	
Carton	This is a case, crate, or barrel of product.	Carton label, Delivery Docket/Manifest, Meat Transfer Certificate (MTC), Official seal, Receipt of purchase/Tax Invoice	
Pallet	A logistic unit which includes a number of cartons or goods items packed together for transport or storage purposes.	Bill of lading/Air Waybill, Delivery Docket/Manifest, Export Health Certificate, Export Permit, Meat Transfer Certificate (MTC), Receipt of purchase/Tax Invoice, Certificate of Analysis (COA), SSCC/Pallet label	
Container System Unit (meat and meat products)	A container designed for use as a unit of cargo handling equipment in the transport of goods by aircraft or ship.	Bill of lading/Air Waybill, Delivery Docket/Manifest, Export Health Certificate, Export Permit, Meat Messaging Consignment Report, Meat Transfer Certificate (MTC), Official seal, Certificate of Analysis (COA), Receipt of purchase/Tax Invoice	

5.2.4.2.2 Information Inputs including Key Data Elements (KDEs)

Key Data Elements (KDEs) are defined as those elements which are key in identifying and tracing the Critical Tracking Event (CTE). Transport of product between establishments is a Critical Tracking Event. Therefore, the KDEs here can largely be found on transportation documentation such as the Bill of lading/Air Waybill, Meat Transfer Certificate (MTC), Export Health Certificate and Certificate of Analysis. Other documentation such as carcase tickets or carton/pallet labels will also contain KDEs.

Table 95. Information inputs, Key Data Elements and Critical Tracking Event related documentation for a small stock refrigerated transport system.

Attributes (including KDEs)	Description of the Attributes (including KDEs)	Is a KDE	Critical Tracking Event (CTE) related documents (including electronic)	More details
Analysis Date	This is the date on which a product sample was analysed.	Yes	Certificate of Analysis (COA)	
Bill of lading/Air Waybill document number	A unique document number issued for traceability purposes.	Yes	Bill of lading/Air Waybill, Certificate of Analysis (COA)	
Body number	This is a number assigned to each carcase by the processor for identification purposes.	Yes	Carcase Ticket	
Certificate of Analysis number	A unique certificate number issued for traceability purposes.	Yes	Certificate of Analysis (COA)	
COA test lot identifier	This is a unique identifier allocated to all cartons, pallets, and shipping	Yes	Certificate of Analysis (COA)	

	containers for which an analysis sample represents.			
Company/product code	This is an in-house code for the identification of the product in the unit.	Yes	Bill of lading/Air Waybill, Carton label, Certificate of Analysis (COA), Receipt of purchase/Tax Invoice, SSSC/Pallet label	
Consignment Serial Shipping Container Code (SSCC)	Encoded in the GS1 barcode, this is a unique number which identifies the individual logistic unit i.e., shipment/message that is assigned by the establishment constructing the unit. The SSCC remains the same for the life of the logistic unit.	Yes	Bill of lading/Air Waybill, Meat Messaging Consignment Report, Meat Transfer Certificate (MTC), SSSC/Pallet label	
Contract number	This is a unique number allocated to the contract by the seller.	Yes	Delivery Docket/Manifest	
Count of Pallets	This is the number of pallets in the logistic unit e.g., container system unit.	Yes	Meat Messaging Consignment Report	
Count of Trade Items	Usually encoded in the GS1 barcode, this is the number of trade items e.g., cartons in the logistic unit.	Yes	Bill of lading/Air Waybill, Delivery Docket/Manifest, Meat Messaging Consignment Report, SSSC/Pallet label	
Date	This is the date of signing or of which a record entry or transaction was made.	Yes	Bill of lading/Air Waybill, Certificate of Analysis (COA), Delivery Docket/Manifest, Meat Messaging Consignment Report, Meat Transfer Certificate (MTC), Receipt of purchase/Tax Invoice	
Delivery Docket/Manifest number	This is a unique number allocated to the docket for identification purposes.	Yes	Delivery Docket/Manifest	
Export Health Certificate Number	A unique number allocated to the health certificate issued for the export consignment for traceability purposes.	Yes	Export Health Certificate, Meat Messaging Consignment Report	For more information visit the Australian Government Federal Register of Legislation.
Export Permit Number	A unique permit number is allocated for the export consignment following submission of a correct and validated Request For Permit (RFP) which is then approved by the Secretary.	Yes	Export Permit	For more information visit the Australian Government Federal Register of Legislation.
From Establishment number	A number issued by Federal and State Authorities to identify the originating site from which meat or meat products were distributed to domestic or export markets. For transfer certificates, the Establishment numbers for both the	Yes	Carcase Ticket, Carton label, Certificate of Analysis (COA), Delivery Docket/Manifest, Export Health Certificate, Meat Messaging Consignment Report, Meat Transfer	

	dispatching and receiving establishments are recorded.		Certificate (MTC), SSCC/Pallet label	
Global Trade Item Number (GTIN)	Encoded in the GS1 barcode, the GTIN is a globally unique 14-digit number used to identify trade items, products, or services.	Yes	Carcase Ticket, Carton label, Meat Messaging Consignment Report, SSCC/Pallet label	For more information visit the GS1 website.
GTIN of Contained Trade Items	Encoded in the GS1 barcode, the GTIN of the contained trade items is a globally unique 14-digit number used to identify trade items, products, or services in the logistic unit.	Yes	SSCC/Pallet label	For more information visit the GS1 website.
Lot number	A lot is a number assigned by the processor to each group of livestock consigned to slaughter and is usually vendor specific.	Yes	Carcase Ticket	
Movement date	The date on which livestock or other products (e.g., feed or meat products) were transported between PICs/establishments.	Yes	Bill of lading/Air Waybill, Certificate of Analysis (COA), Delivery Docket/Manifest, Export Health Certificate, Meat Transfer Certificate (MTC)	
MSA eating quality group/grade	This identifies carcasses with similar MSA and eating quality grades, these may align with brands packed by the processor for logistic simplicity. Carcasses are grouped for boning according to eating quality grades.	Yes	MSA Carcase Ticket	For more information on MSA visit the MLA website.
MSA Licence Number	Any establishment consigning, supplying, or identifying MSA Certified Product must be registered and have a unique MSA Licence Number.	Yes	Receipt of purchase/Tax Invoice	For more information on MSA visit the MLA website.
Net Weight (Kilograms)	Usually encoded in the GS1 barcode, the Net Weight is a variable measure of the trade item e.g., carton, pallet or shipment recorded in kilograms.	Yes	Bill of lading/Air Waybill, Carcase Ticket, Carton label, Export Health Certificate, Meat Messaging Consignment Report, SSCC/Pallet label	For more information visit the GS1 website.
Official mark	Any stamp, seal, label, or mark that is declared by the regulations to be an official mark. An official mark signifies that the product has been inspected by and approved as safe for human consumption by an Authorised Officer.	Yes	Carcase Ticket, Carton label, SSCC/Pallet label	For more information visit the Australian Government Federal Register of Legislation.
Order date	This is the date on which the purchase order or contract was raised by the buyer.	Yes	Delivery Docket/Manifest	
Packaging Date	Encoded in the GS1 barcode, the Packaging Date is the date on which the item was packaged and is recorded in the format year, month, day (YYMMDD).	Yes	Carton label, Certificate of Analysis (COA), SSCC/Pallet label	For more information visit the GS1 website.
Trade description	This is a collective set of words that says what the product is and may	Yes	Carcase Ticket, Carton label, Delivery	

	include information such as species, net weight of product, name and address of establishments, category ciphers, market endorsements, MSA eating quality etc.		Docket/Manifest, Export Health Certificate, Meat Messaging Consignment Report, Meat Transfer Certificate (MTC), SSCC/Pallet label	
Packaging Date Range	This includes the oldest and newest packaging dates for the logistic unit.	Yes	SSCC/Pallet label	For more information visit the GS1 website.
Pallet Serial Shipping Container Code (SSCC)	Encoded in the GS1 barcode, this is a unique number which identifies the individual logistic unit i.e., pallet that is assigned by the establishment constructing the unit. The SSCC remains the same for the life of the logistic unit.	Yes	Meat Messaging Consignment Report, Meat Transfer Certificate (MTC), SSCC/Pallet label	For more information visit the GS1 website.
Production Date (YYMMDD)	Encoded in the GS1 barcode, this is the 'kill' or slaughter' date of the product and is recorded in the format year, month, day (YYMMDD).	Yes	Carcase Ticket, Certificate of Analysis (COA), Meat Transfer Certificate (MTC)	For more information visit the GS1 website.
Recipient Australian Business Number (ABN)	This is an 11-digit registration number, issued by the Australian Tax Office, used to identify businesses.	Yes	Receipt of purchase/Tax Invoice	For more information visit the ATO website.
Seal Serial Number	This is a unique serial number printed on any tamper-evident seal issued by the Department.	Yes	Bill of lading/Air Waybill, Meat Transfer Certificate (MTC), Official seal	For more information visit the GS1 website.
Seller/Supplier Australian Business Number (ABN)	This is an 11-digit registration number, issued by the Australian Tax Office, used to identify businesses.	Yes	Receipt of purchase/Tax Invoice	For more information visit the ATO website.
Serial Number	Encoded in the GS1 barcode, this is a code, numeric or alphanumeric, assigned to an individual instance of an item for its lifetime.	Yes	Carcase Ticket, Carton label	For more information visit the GS1 website.
Shipping Mark	Also known as a port mark, this is a code comprising of three letters representing the foreign establishment number and the last nine digits of the consignment SSCC.	Yes	Bill of lading/Air Waybill, Certificate of Analysis (COA), Delivery Docket/Manifest, Export Health Certificate, Meat Messaging Consignment Report, SSCC/Pallet label	
To Establishment number	A number issued by Federal and State Authorities to identify the originating site from which meat or meat products were distributed to domestic or export markets. For transfer certificates, the Establishment numbers for both the dispatching and receiving establishments are recorded.	Yes	Meat Transfer Certificate (MTC)	
Transfer Certificate number	A unique certificate number issued for traceability purposes.	Yes	Meat Messaging Consignment Report, Meat Transfer Certificate (MTC)	For more information visit the Department

				of Agriculture, Water and the Environment website.
Transport registration number	The registration number of the vehicle in which the animals or product were transported. For shipments of product this will be a shipping container number.	Yes	Bill of lading/Air Waybill, Delivery Docket/Manifest, Export Health Certificate, Meat Messaging Consignment Report, Meat Transfer Certificate (MTC)	

5.2.4.2.3 Physical Outputs including Critical Tracking Events (CTEs)

As the refrigerated transportation process involves the movement of product between establishments, the physical outputs are the same as for the physical inputs. This may include product in carcase, carton or palletised form or product packed into shipping containers ready for export.

Critical Tracking Events (CTEs) are defined as those events which include the growing, receiving, transforming, creating, and shipping of food products. Such events are critical to the traceability of product throughout the supply chain.

The CTEs associated with the outputs of the refrigerated transport system include the movement of:

- Carcase
- Carton
- Pallet
- Container System Unit (meat and meat products)

off the property, premises, or supply chain sector.

Table 96. Physical outputs and associated Critical Tracking Event related documents for a small stock refrigerated transport system.

Event related to the inputs	Description of the inputs	Critical Tracking Event (CTE) related documents (including electronic)	More details
Carcase	The body of a slaughtered animal after bleeding. Becomes a dressed carcase when hide, head, feet and offal are removed.	Carcase Ticket, Delivery Docket/Manifest, Meat Transfer Certificate (MTC), MSA Carcase Ticket, Receipt of purchase/Tax Invoice	
Carton	This is a case, crate, or barrel of product.	Carton label, Delivery Docket/Manifest, Meat Transfer Certificate (MTC), Official seal, Receipt of purchase/Tax Invoice	
Pallet	A logistic unit which includes a number of cartons or goods items packed together for transport or storage purposes.	Bill of lading/Air Waybill, Delivery Docket/Manifest, Export Health Certificate, Export Permit, Meat Transfer Certificate (MTC), Receipt of purchase/Tax Invoice, Certificate of Analysis (COA), SSCC/Pallet label	
Container System Unit (meat and meat products)	A container designed for use as a unit of cargo handling equipment in the transport of goods by aircraft or ship.	Bill of lading/Air Waybill, Delivery Docket/Manifest, Export Health Certificate, Export Permit, Meat Messaging Consignment Report, Meat Transfer Certificate (MTC), Official seal, Certificate of Analysis (COA), Receipt of purchase/Tax Invoice	

5.2.4.2.4 Information Outputs including Key Data Elements (KDEs)

Key Data Elements (KDEs) are defined as those elements which are key in identifying and tracing the Critical Tracking Event (CTE). Transport of product between establishments is a Critical Tracking Event. Therefore, the KDEs here can largely be found on transportation documentation such as the Bill of lading/Air Waybill, Meat Transfer Certificate (MTC), Export Health Certificate and Certificate of Analysis. Other documentation such as carcase tickets or carton/pallet labels will also contain KDEs.

Table 97. Information outputs, Key Data Elements and Critical Tracking Event related documentation for a small stock refrigerated transport system.

Attributes (including KDEs)	Description of the Attributes (including KDEs)	Is a KDE	Critical Tracking Event (CTE) related documents (including electronic)	More details
Analysis Date	This is the date on which a product sample was analysed.	Yes	Certificate of Analysis (COA)	
Bill of lading/Air Waybill document number	A unique document number issued for traceability purposes.	Yes	Bill of lading/Air Waybill, Certificate of Analysis (COA)	
Body number	This is a number assigned to each carcase by the processor for identification purposes.	Yes	Carcase Ticket	
Certificate of Analysis number	A unique certificate number issued for traceability purposes.	Yes	Certificate of Analysis (COA)	
COA test lot identifier	This is a unique identifier allocated to all cartons, pallets, and shipping containers for which an analysis sample represents.	Yes	Certificate of Analysis (COA)	
Company/product code	This is an in-house code for the identification of the product in the unit.	Yes	Bill of lading/Air Waybill, Carton label, Certificate of Analysis (COA), Receipt of purchase/Tax Invoice, SSCC/Pallet label	
Consignment Serial Shipping Container Code (SSCC)	Encoded in the GS1 barcode, this is a unique number which identifies the individual logistic unit i.e., shipment/message that is assigned by the establishment constructing the unit. The SSCC remains the same for the life of the logistic unit.	Yes	Bill of lading/Air Waybill, Meat Messaging Consignment Report, Meat Transfer Certificate (MTC), SSCC/Pallet label	For more information visit the GS1 website.
Contract number	This is a unique number allocated to the contract by the seller.	Yes	Delivery Docket/Manifest	
Count of Trade Items	Usually encoded in the GS1 barcode, this is the number of trade items e.g., cartons in the logistic unit.	Yes	Bill of lading/Air Waybill, Delivery Docket/Manifest, Meat Messaging Consignment Report, SSCC/Pallet label	For more information visit the GS1 website.
Date	This is the date of signing or of which a record entry or transaction was made.	Yes	Bill of lading/Air Waybill, Certificate of Analysis (COA), Delivery Docket/Manifest, Meat Messaging Consignment	

			Report, Meat Transfer Certificate (MTC), Receipt of purchase/Tax Invoice	
Delivery Docket/Manifest number	This is a unique number allocated to the docket for identification purposes.	Yes	Delivery Docket/Manifest	
Export Health Certificate Number	A unique number allocated to the health certificate issued for the export consignment for traceability purposes.	Yes	Export Health Certificate, Meat Messaging Consignment Report	For more information visit the Australian Government Register of Legislation.
Export Permit Number	A unique permit number is allocated for the export consignment following submission of a correct and validated Request For Permit (RFP) which is then approved by the Secretary.	Yes	Export Permit	For more information visit the Australian Government Register of Legislation.
From Establishment number	A number issued by Federal and State Authorities to identify the originating site from which meat or meat products were distributed to domestic or export markets. For transfer certificates, the Establishment numbers for both the dispatching and receiving establishments are recorded.	Yes	Carcase Ticket, Carton label, Certificate of Analysis (COA), Delivery Docket/Manifest, Export Health Certificate, Meat Messaging Consignment Report, Meat Transfer Certificate (MTC), SSCC/Pallet label	
Global Trade Item Number (GTIN)	Encoded in the GS1 barcode, the GTIN is a globally unique 14-digit number used to identify trade items, products, or services.	Yes	Carcase Ticket, Carton label, Meat Messaging Consignment Report, SSCC/Pallet label	For more information visit the GS1 website.
GTIN of Contained Trade Items	Encoded in the GS1 barcode, the GTIN of the contained trade items is a globally unique 14-digit number used to identify trade items, products, or services in the logistic unit.	Yes	SSCC/Pallet label	For more information visit the GS1 website.
Lot number	A lot is a number assigned by the processor to each group of livestock consigned to slaughter and is usually vendor specific.	Yes	Carcase Ticket	
Movement date	The date on which livestock or other products (e.g., feed or meat products) were transported between PICs/establishments.	Yes	Bill of lading/Air Waybill, Certificate of Analysis (COA), Delivery Docket/Manifest, Export Health Certificate, Meat Transfer Certificate (MTC)	
MSA eating quality group/grade	This identifies carcasses with similar MSA and eating quality grades, these may align with brands packed by the processor for logistic simplicity. Carcasses are grouped for boning according to eating quality grades.	Yes	MSA Carcase Ticket	For more information on MSA visit the MLA website.

MSA Licence Number	Any establishment consigning, supplying, or identifying MSA Certified Product must be registered and have a unique MSA Licence Number.	Yes	Receipt of purchase/Tax Invoice	For more information on MSA visit the MLA website.
Net Weight (Kilograms)	Usually encoded in the GS1 barcode, the Net Weight is a variable measure of the trade item e.g., carton, pallet or shipment recorded in kilograms.	Yes	Bill of lading/Air Waybill, Carcase Ticket, Carton label, Export Health Certificate, Meat Messaging Consignment Report, SSCC/Pallet label	For more information visit the GS1 website.
Official mark	Any stamp, seal, label, or mark that is declared by the regulations to be an official mark. An official mark signifies that the product has been inspected by and approved as safe for human consumption by an Authorised Officer.	Yes	Carcase Ticket, Carton label, SSCC/Pallet label	For more information visit the Australian Government Federal Register of Legislation.
Order date	This is the date on which the purchase order or contract was raised by the buyer.	Yes	Delivery Docket/Manifest	
Packaging Date	Encoded in the GS1 barcode, the Packaging Date is the date on which the item was packaged and is recorded in the format year, month, day (YYMMDD).	Yes	Carton label, Certificate of Analysis (COA), SSCC/Pallet label	For more information visit the GS1 website.
Packaging Date Range	This includes the oldest and newest packaging dates for the logistic unit.	Yes	SSCC/Pallet label	
Pallet Serial Shipping Container Code (SSCC)	Encoded in the GS1 barcode, this is a unique number which identifies the individual logistic unit i.e., pallet that is assigned by the establishment constructing the unit. The SSCC remains the same for the life of the logistic unit.	Yes	Meat Messaging Consignment Report, Meat Transfer Certificate (MTC), SSCC/Pallet label	For more information visit the GS1 website.
Production Date (YYMMDD)	Encoded in the GS1 barcode, this is the 'kill' or slaughter' date of the product and is recorded in the format year, month, day (YYMMDD).	Yes	Carcase Ticket, Certificate of Analysis (COA), Meat Transfer Certificate (MTC)	For more information visit the GS1 website.
Recipient Australian Business Number (ABN)	This is an 11-digit registration number, issued by the Australian Tax Office, used to identify businesses.	Yes	Receipt of purchase/Tax Invoice	For more information visit the ATO website.
Seal Serial Number	This is a unique serial number printed on any tamper-evident seal issued by the Department.	Yes	Bill of lading/Air Waybill, Meat Transfer Certificate (MTC), Official seal	For more information visit the Australian Government Federal Register of Legislation.
Seller/Supplier Australian Business Number (ABN)	This is an 11-digit registration number, issued by the Australian Tax Office, used to identify businesses.	Yes	Receipt of purchase/Tax Invoice	For more information visit the ATO website.
Serial Number	Encoded in the GS1 barcode, this is a code, numeric or alphanumeric,	Yes	Carcase Ticket, Carton label	For more information

	assigned to an individual instance of an item for its lifetime.			visit the GS1 website.
Shipping Mark	Also known as a port mark, this is a code comprising of three letters representing the foreign establishment number and the last nine digits of the consignment SSCC.	Yes	Bill of lading/Air Waybill, Certificate of Analysis (COA), Delivery Docket/Manifest, Export Health Certificate, Meat Messaging Consignment Report, SSCC/Pallet label	
To Establishment number	A number issued by Federal and State Authorities to identify the originating site from which meat or meat products were distributed to domestic or export markets. For transfer certificates, the Establishment numbers for both the dispatching and receiving establishments are recorded.	Yes	Meat Transfer Certificate (MTC)	
Trade description	This is a collective set of words that says what the product is and may include information such as species, net weight of product, name and address of establishments, category ciphers, market endorsements, MSA eating quality etc.	Yes	Carcase Ticket, Carton label, Delivery Docket/Manifest, Export Health Certificate, Meat Messaging Consignment Report, Meat Transfer Certificate (MTC), SSCC/Pallet label	
Transfer Certificate number	A unique certificate number issued for traceability purposes.	Yes	Meat Messaging Consignment Report, Meat Transfer Certificate (MTC)	For more information visit the Department of Agriculture, Water and the Environment website.
Transport registration number	The registration number of the vehicle in which the animals or product were transported. For shipments of product this will be a shipping container number.	Yes	Bill of lading/Air Waybill, Delivery Docket/Manifest, Export Health Certificate, Meat Messaging Consignment Report, Meat Transfer Certificate (MTC)	

5.2.4.2.5 Regulatory and Industry Programs

- AUS-MEAT
- Department of Agriculture
- Meat Messaging
- Meat Standards Australia (MSA)
- Other data sources
- State food authority

5.2.4.2.6 Supply Chain Node Traceability

The traceability of product undergoing refrigerated transport back to the live animal and property of origin is dependent on the form in which the product is being transported.

For carcasses, traceability back to the live animal is possible and can be done by the processing establishment where the animal was slaughtered. Here, carcasses are issued a carcass ticket which correlates to the live animal identifier and contains key information, including GS1 meat industry barcode, body number, processing establishment number and production date or 'kill date'. This information is uploaded to the NLIS Database, by the processor, under the processing establishments Property Identification Code (PIC). Thus, there is the potential to trace whole carcasses undergoing refrigerated transport back to the individual live animal and property of origin.

For cartoned and palletised product, each identified by unique serialised carton or product labels respectively, including a GS1 meat industry barcode, traceability is limited to the carcasses that have entered the boning room for the production run of cartons that were created. For example, 200 carcasses (400 sides) individually identified with unique carcass tickets enter the boning room for a specific boning run. These carcass tickets are linked to the specific boning run. From these carcasses, 3 200 cartons of primal cuts and 1 000 cartons of trim and other highly mixed products are created. While all cartons are identified with unique serialised carton labels linked to the boning run (and may be packaged into pallets containing unique serialised pallet labels including a GS1 SSCC barcode), it is not readily possible to identify which carcasses are in which cartons as the cartons will contain meat products from different carcasses. If the carcasses were sourced from several different properties, the resulting carton can only be traced to a number of possible carcasses and source properties. In logistical systems such as transport and cold stores, cartons are typically processed by pallets with only the pallet label being scanned. Therefore, traceability through logistics is often at the pallet level.

All meat product transferred between establishments must be accompanied by a Meat Transfer Certificate (MTC) which details the serialised logistic unit identifiers such as the Serial Shipping Container Code (SSCC). This allows traceability of the unit and its subunits back to either the live animal and property of origin (for carcasses) or the boning room production run (for cartons and pallets).

5.2.4.2.7 Data flow diagrams

Table 98. Data flow diagrams for the inputs and outputs of a small stock refrigerated transport system.

Direction	Description
Input	Load instruction/ run sheet to Transport
Output	Delivery receipt to Receiving party

5.2.4.2.7.1 Load instructions/run sheet to Transport

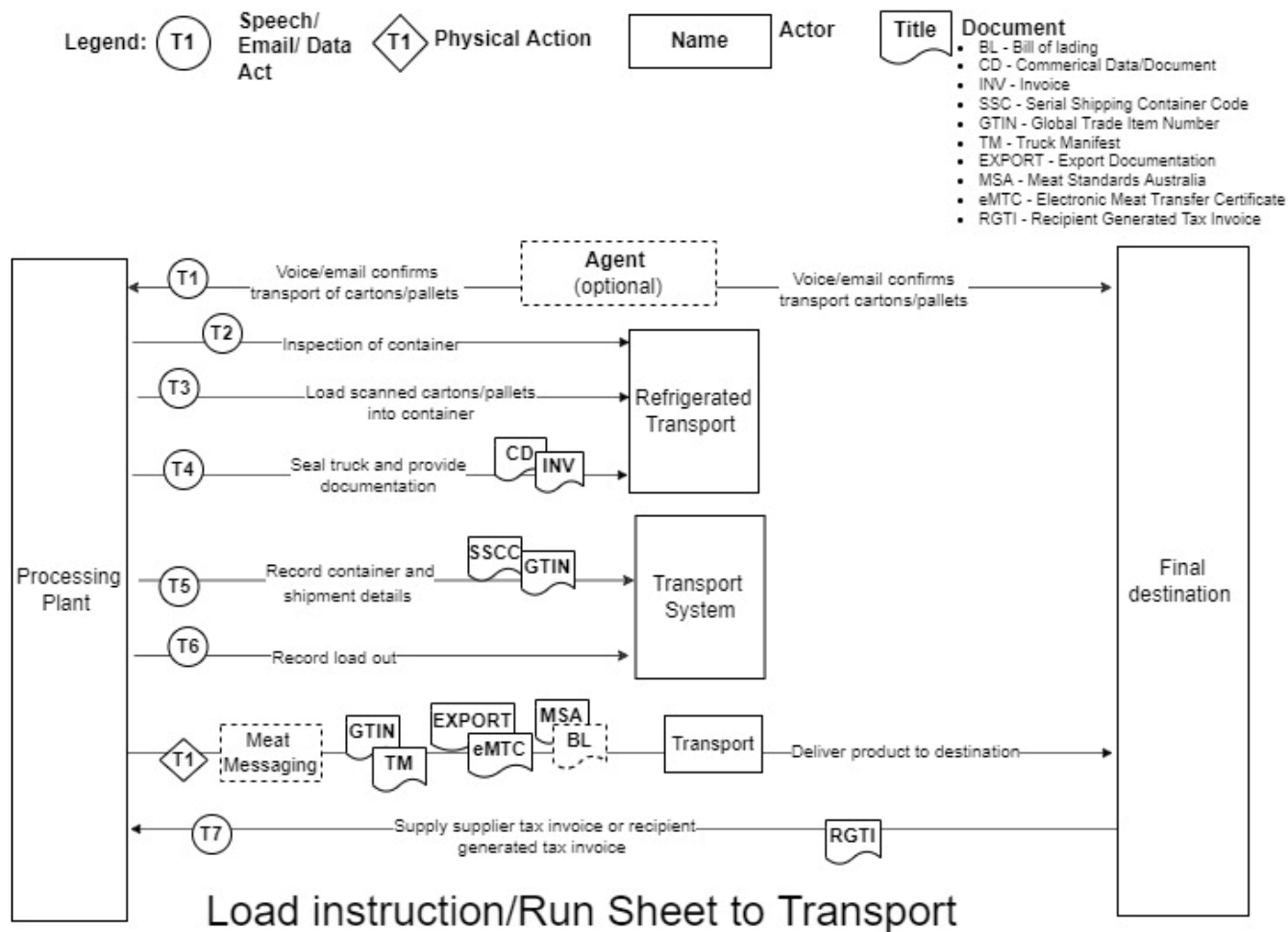

Figure 116. Data or information flow from the load instruction/run sheet to transport in the small stock supply chain.

5.2.4.2.7.2 Delivery Receipt to Receiving Party

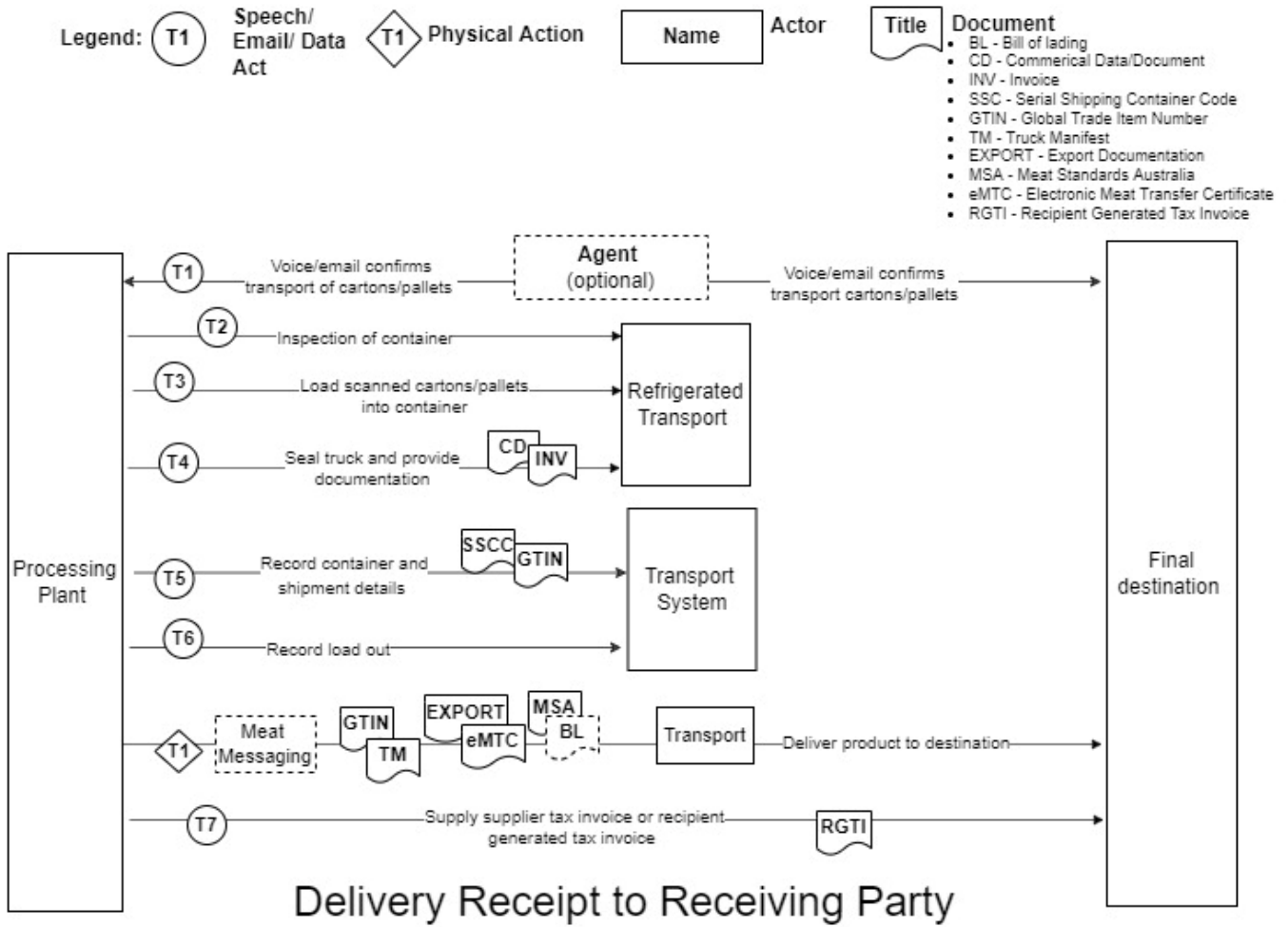

Figure 117. Data or information flow from the delivery receipt to receiving party in the small stock supply chain.

5.2.4.3 Bulk transport

Bulk transport involves the movement (including loading and unloading) of by-products (from render) or hides from one premises to another. These labelled products are typically transported to export ports where they are assembled and loaded for export via ship or airfreight. By-products and hides are subsequently manufactured into leather, feed, fertilizer, and pharmaceutical products for commercial distribution. All bulk transport movements must be accompanied by Critical Tracking Event related documents such as the Animal By Product Transfer Certificate (BPTC).

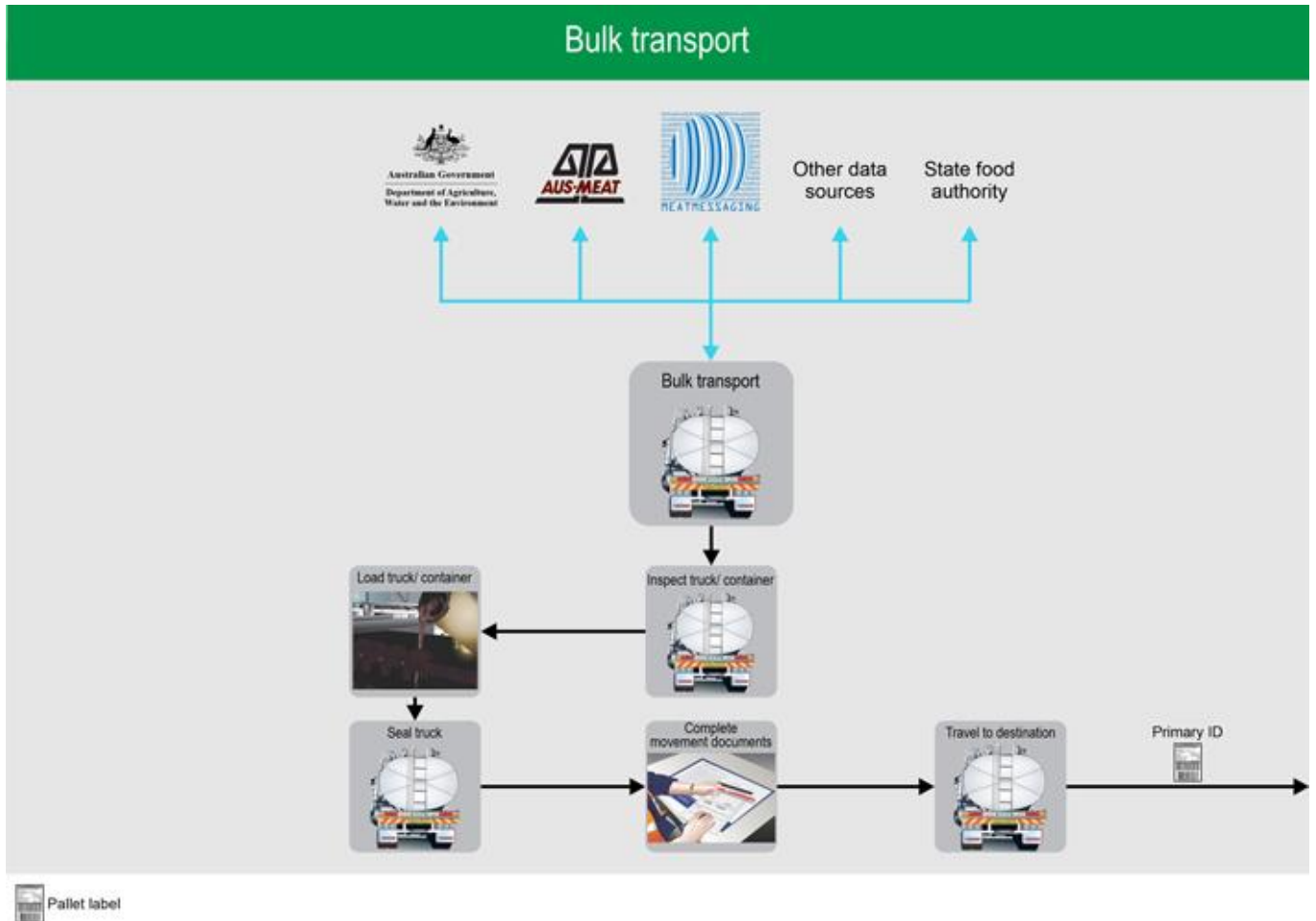

Figure 118. Inputs and outputs of the small stock supply chain bulk transport sector.

5.2.4.3.1 Physical Inputs including Critical Tracking Events (CTEs)

Physical inputs into the bulk transport system may include animal by products from rendering or hide processing facilities. Documentation required to accompany such product is largely similar to that of product approved for human consumption. However, documents pertaining explicitly to product consumption i.e., edible/inedible, are replaced here by alternative regulated documentation. For example, as bulk transport product is inedible the Meat Transfer Certificate is replaced by an Animal By Product Transfer Certificate (BPTC) for non-prescribed goods.

Critical Tracking Events (CTEs) are defined as those events which include the growing, receiving, transforming, creating and shipping of food products. Such events are critical to the traceability of product throughout the supply chain.

The CTEs associated with inputs to the bulk transport system include the receipt of:

- Rendered product store bag
- Pallet
- Container System Unit (render and hide product).

Table 99. Physical inputs and associated Critical Tracking Event related documents for a small stock bulk transport system.

Event related to the inputs	Description of the inputs	Critical Tracking Event (CTE) related documents (including electronic)	More details
Rendered product store bag	A large storage bag which can temporarily store large quantities of product.	Animal By Product Transfer Certificate (BPTC), Bill of lading/Air Waybill, Certificate of Analysis (COA), Delivery Docket/Manifest, Export clearance documentation, Export Permit, Receipt of purchase/Tax Invoice, SSCC/Store bag label	
Pallet	A logistic unit which includes a number of cartons or goods items packed together for transport or storage purposes.	Animal By Product Transfer Certificate (BPTC), Bill of lading/Air Waybill, Certificate of Analysis (COA), Delivery Docket/Manifest, Export clearance documentation, Export Permit, Receipt of purchase/Tax Invoice, SSCC/Pallet label	
Container System Unit (render and hide product)	A container designed for use as a unit of cargo handling equipment in the transport of goods by aircraft or ship.	Animal By Product Transfer Certificate (BPTC), Bill of lading/Air Waybill, Certificate of Analysis (COA), Delivery Docket/Manifest, Export clearance documentation, Export Permit, Meat Messaging Consignment Report, Receipt of purchase/Tax Invoice	

5.2.4.3.2 Information Inputs including Key Data Elements (KDEs)

Key Data Elements (KDEs) are defined as those elements which are key in identifying and tracing the Critical Tracking Event (CTE). The transport of product between establishments is a Critical Tracking Event. Therefore, the KDEs here can largely be found on transportation documentation such as the Bill of lading/Air Waybill, Animal By Product Transfer Certificate (BPTC), Export clearance documentation and Certificate of Analysis. Other documentation such as Receipts of purchase/Tax Invoices and store bag or pallet labels will also contain KDEs.

Table 100. Information inputs, Key Data Elements and Critical Tracking Event related documentation for a small stock bulk transport system.

Attributes (including KDEs)	Description of the Attributes (including KDEs)	Is a KDE	Critical Tracking Event (CTE) related documents (including electronic)	More details
Analysis Date	This is the date on which a product sample was analysed.	Yes	Certificate of Analysis (COA)	
Bill of lading/Air Waybill document number	A unique document number issued for traceability purposes.	Yes	Bill of lading/Air Waybill, Certificate of Analysis (COA)	
Certificate of Analysis number	A unique certificate number issued for traceability purposes.	Yes	Certificate of Analysis (COA)	
COA test lot identifier	This is a unique identifier allocated to all cartons, pallets, and shipping containers for which an analysis sample represents.	Yes	Certificate of Analysis (COA)	

Company/product code	This is an in-house code for the identification of the product in the unit.	Yes	Bill of lading/Air Waybill, Certificate of Analysis (COA), Receipt of purchase/Tax Invoice, SSCC/Pallet label, SSCC/Store bag label	
Consignment Serial Shipping Container Code (SSCC)	Encoded in the GS1 barcode, this is a unique number which identifies the individual logistic unit i.e., shipment/message that is assigned by the establishment constructing the unit. The SSCC remains the same for the life of the logistic unit.	Yes	Animal By Product Transfer Certificate (BPTC), Bill of lading/Air Waybill, Export clearance documentation, Meat Messaging Consignment Report, SSCC/Pallet label, SSCC/Store bag label	For more information visit the GS1 website.
Contract number	This is a unique number allocated to the contract by the seller.	Yes	Delivery Docket/Manifest	
Count of Pallets	This is the number of pallets in the logistic unit e.g., container system unit.	Yes	Meat Messaging Consignment Report	
Count of Trade Items	Usually encoded in the GS1 barcode, this is the number of trade items e.g., cartons in the logistic unit.	Yes	Bill of lading/Air Waybill, Delivery Docket/Manifest, Meat Messaging Consignment Report, SSCC/Pallet label, SSCC/Store bag label	For more information visit the GS1 website.
Date	This is the date of signing or of which a record entry or transaction was made.	Yes	Animal By Product Transfer Certificate (BPTC), Bill of lading/Air Waybill, Certificate of Analysis (COA), Delivery Docket/Manifest, Export clearance documentation, Meat Messaging Consignment Report, Receipt of purchase/Tax Invoice	
Delivery Docket/Manifest number	This is a unique number allocated to the docket for identification purposes.	Yes	Delivery Docket/Manifest	
Export Health Certificate Number	A unique number allocated to the health certificate issued for the export consignment for traceability purposes.	Yes	Meat Messaging Consignment Report	For more information visit the Australian Government Federal Register of Legislation.
Export Permit Number	A unique permit number is allocated for the export consignment following submission of a correct and validated Request For Permit (RFP) which is then approved by the Secretary.	Yes	Export Permit	For more information visit the Australian Government Federal Register of Legislation.

From Establishment number	A number issued by Federal and State Authorities to identify the originating site from which meat or meat products were distributed to domestic or export markets. For transfer certificates, the Establishment numbers for both the dispatching and receiving establishments are recorded.	Yes	Animal By Product Transfer Certificate (BPTC), Certificate of Analysis (COA), Delivery Docket/Manifest, Export clearance documentation, Meat Messaging Consignment Report, SSCC/Pallet label, SSCC/Store bag label	
Global Trade Item Number (GTIN)	Encoded in the GS1 barcode, the GTIN is a globally unique 14-digit number used to identify trade items, products, or services.	Yes	Meat Messaging Consignment Report, SSCC/Pallet label, SSCC/Store bag label	For more information visit the GS1 website.
GTIN of Contained Trade Items	Encoded in the GS1 barcode, the GTIN of the contained trade items is a globally unique 14-digit number used to identify trade items, products, or services in the logistic unit.	Yes	SSCC/Pallet label, SSCC/Store bag label	For more information visit the GS1 website.
Movement date	The date on which livestock or other products (e.g., feed or meat products) were transported between PICs/establishments.	Yes	Animal By Product Transfer Certificate (BPTC), Bill of lading/Air Waybill, Certificate of Analysis (COA), Delivery Docket/Manifest, Export clearance documentation	
Net Weight (Kilograms)	Usually encoded in the GS1 barcode, the Net Weight is a variable measure of the trade item e.g., carton, pallet or shipment recorded in kilograms.	Yes	Bill of lading/Air Waybill, Meat Messaging Consignment Report, SSCC/Pallet label, SSCC/Store bag label	For more information visit the GS1 website.
Official mark	Any stamp, seal, label, or mark that is declared by the regulations to be an official mark. An official mark signifies that the product has been inspected by and approved as safe for human consumption by an Authorised Officer.	Yes	SSCC/Pallet label	For more information visit the Australian Government Federal Register of Legislation.
Order date	This is the date on which the purchase order or contract was raised by the buyer.	Yes	Delivery Docket/Manifest	
Packaging Date	Encoded in the GS1 barcode, the Packaging Date is the date on which the item was packaged and is recorded in the format year, month, day (YYMMDD).	Yes	Certificate of Analysis (COA), SSCC/Pallet label, SSCC/Store bag label	For more information visit the GS1 website.
Packaging Date Range	This includes the oldest and newest packaging dates for the logistic unit.	Yes	Export clearance documentation, SSCC/Pallet label, SSCC/Store bag label	
Pallet Serial Shipping Container Code (SSCC)	Encoded in the GS1 barcode, this is a unique number which identifies the individual logistic unit i.e., pallet that is assigned by the	Yes	Animal By Product Transfer Certificate (BPTC), Export clearance documentation, Meat Messaging	For more information visit the GS1 website.

	establishment constructing the unit. The SSCC remains the same for the life of the logistic unit.		Consignment Report, SSCC/Pallet label, SSCC/Store bag label	
Production Date (YYMMDD)	Encoded in the GS1 barcode, this is the 'kill' or slaughter' date of the product and is recorded in the format year, month, day (YYMMDD).	Yes	Animal By Product Transfer Certificate (BPTC), Certificate of Analysis (COA)	For more information visit the GS1 website.
Recipient Australian Business Number (ABN)	This is an 11-digit registration number, issued by the Australian Tax Office, used to identify businesses.	Yes	Receipt of purchase/Tax Invoice	For more information visit the ATO website.
Seal Serial Number	This is a unique serial number printed on any tamper-evident seal issued by the Department.	Yes	Animal By Product Transfer Certificate (BPTC), Bill of lading/Air Waybill, Export clearance documentation	For more information visit the GS1 website.
Seller/Supplier Australian Business Number (ABN)	This is an 11-digit registration number, issued by the Australian Tax Office, used to identify businesses.	Yes	Receipt of purchase/Tax Invoice	For more information visit the ATO website.
Shipping Mark	Also known as a port mark, this is a code comprising of three letters representing the foreign establishment number and the last nine digits of the consignment SSCC.	Yes	Bill of lading/Air Waybill, Certificate of Analysis (COA), Delivery Docket/Manifest, Meat Messaging Consignment Report, SSCC/Pallet label, SSCC/Store bag label	
To Establishment number	A number issued by Federal and State Authorities to identify the originating site from which meat or meat products were distributed to domestic or export markets. For transfer certificates, the Establishment numbers for both the dispatching and receiving establishments are recorded.	Yes	Animal By Product Transfer Certificate (BPTC), Export clearance documentation	
Trade description	This is a collective set of words that says what the product is and may include information such as species, net weight of product, name and address of establishments, category ciphers, market endorsements, MSA eating quality etc.	Yes	Animal By Product Transfer Certificate (BPTC), Delivery Docket/Manifest, Export clearance documentation, Meat Messaging Consignment Report, SSCC/Pallet label, SSCC/Store bag label	
Transfer Certificate number	A unique certificate number issued for traceability purposes.	Yes	Animal By Product Transfer Certificate (BPTC), Meat Messaging Consignment Report	For more information visit the Department of Agriculture, Water and the Environment website.

Transport registration number	The registration number of the vehicle in which the animals or product were transported. For shipments of product this will be a shipping container number.	Yes	Animal By Product Transfer Certificate (BPTC), Bill of lading/Air Waybill, Delivery Docket/Manifest, Export clearance documentation, Meat Messaging Consignment Report	
-------------------------------	---	-----	--	--

5.2.4.3.3 Physical Outputs including Critical Tracking Events (CTEs)

Physical outputs of the bulk transport system include products (animal by products from rendering or hide processing facilities) which have been loaded into shipping containers ready for export. Documentation required to accompany such product is largely similar to that of product approved for human consumption. However, documents pertaining explicitly to product consumption i.e., edible/inedible, are replaced here by alternative regulated documentation. For example, as bulk transport product is inedible the Meat Transfer Certificate is replaced by an Animal By Product Transfer Certificate (BPTC) for non-prescribed goods.

Critical Tracking Events (CTEs) are defined as those events which include the growing, receiving, transforming, creating and shipping of food products. Such events are critical to the traceability of product throughout the supply chain.

The CTEs associated with the outputs of the bulk transport system include the movement of:

- Container System Unit (render and hide product)

off the property, premises, or supply chain sector.

Table 101. Physical outputs and associated Critical Tracking Event related documents for a small stock bulk transport system.

Event related to the inputs	Description of the inputs	Critical Tracking Event (CTE) related documents (including electronic)	More details
Container System Unit (render and hide product)	A container designed for use as a unit of cargo handling equipment in the transport of goods by aircraft or ship.	Animal By Product Transfer Certificate (BPTC), Bill of lading/Air Waybill, Certificate of Analysis (COA), Delivery Docket/Manifest, Export clearance documentation, Export Permit, Meat Messaging Consignment Report, Receipt of purchase/Tax Invoice	

5.2.4.3.4 Information Outputs including Key Data Elements (KDEs)

Key Data Elements (KDEs) are defined as those elements which are key in identifying and tracing the Critical Tracking Event (CTE). The transport of product between establishments is a Critical Tracking Event. Therefore, the KDEs here can largely be found on transportation documentation such as the Bill of lading/Air Waybill, Animal By Product Transfer Certificate (BPTC), Export clearance documentation and Certificate of Analysis. Other documentation such as Receipts of purchase/Tax Invoices and store bag or pallet labels and Meat Messaging Consignment Reports will also contain KDEs.

Table 102. Information outputs, Key Data Elements and Critical Tracking Event related documentation for a small stock bulk transport system.

Attributes (including KDEs)	Description of the Attributes (including KDEs)	Is a KDE	Critical Tracking Event (CTE) related documents (including electronic)	More details

Analysis Date	This is the date on which a product sample was analysed.	Yes	Certificate of Analysis (COA)	
Bill of lading/Air Waybill document number	A unique document number issued for traceability purposes.	Yes	Bill of lading/Air Waybill, Certificate of Analysis (COA)	
Certificate of Analysis number	A unique certificate number issued for traceability purposes.	Yes	Certificate of Analysis (COA)	
COA test lot identifier	This is a unique identifier allocated to all cartons, pallets, and shipping containers for which an analysis sample represents.	Yes	Certificate of Analysis (COA)	
Company/product code	This is an in-house code for the identification of the product in the unit.	Yes	Bill of lading/Air Waybill, Certificate of Analysis (COA), Receipt of purchase/Tax Invoice	
Consignment Serial Shipping Container Code (SSCC)	Encoded in the GS1 barcode, this is a unique number which identifies the individual logistic unit i.e., shipment/message that is assigned by the establishment constructing the unit. The SSCC remains the same for the life of the logistic unit.	Yes	Animal By Product Transfer Certificate (BPTC), Bill of lading/Air Waybill, Export clearance documentation, Meat Messaging Consignment Report	For more information visit the GS1 website.
Contract number	This is a unique number allocated to the contract by the seller.	Yes	Delivery Docket/Manifest	
Count of Pallets	This is the number of pallets in the logistic unit e.g., container system unit.	Yes	Meat Messaging Consignment Report	
Count of Trade Items	Usually encoded in the GS1 barcode, this is the number of trade items e.g., cartons in the logistic unit.	Yes	Bill of lading/Air Waybill, Delivery Docket/Manifest, Meat Messaging Consignment Report	For more information visit the GS1 website.
Date	This is the date of signing or of which a record entry or transaction was made.	Yes	Animal By Product Transfer Certificate (BPTC), Bill of lading/Air Waybill, Certificate of Analysis (COA), Delivery Docket/Manifest, Export clearance documentation, Meat Messaging Consignment Report, Receipt of purchase/Tax Invoice	
Delivery Docket/Manifest number	This is a unique number allocated to the docket for identification purposes.	Yes	Delivery Docket/Manifest	
Export Health Certificate Number	A unique number allocated to the health certificate issued for the export consignment for traceability purposes.	Yes	Meat Messaging Consignment Report	For more information visit the Australian Government Federal Register of Legislation.
Export Permit Number	A unique permit number is allocated for the export consignment following submission of a correct and validated Request For Permit (RFP)	Yes	Export Permit	For more information visit the Australian Government

	which is then approved by the Secretary.			Federal Register of Legislation.
From Establishment number	A number issued by Federal and State Authorities to identify the originating site from which meat or meat products were distributed to domestic or export markets. For transfer certificates, the Establishment numbers for both the dispatching and receiving establishments are recorded.	Yes	Animal By Product Transfer Certificate (BPTC), Certificate of Analysis (COA), Delivery Docket/Manifest, Export clearance documentation, Meat Messaging Consignment Report	
Global Trade Item Number (GTIN)	Encoded in the GS1 barcode, the GTIN is a globally unique 14-digit number used to identify trade items, products, or services.	Yes	Meat Messaging Consignment Report	For more information visit the GS1 website.
Movement date	The date on which livestock or other products (e.g., feed or meat products) were transported between PICs/establishments.	Yes	Animal By Product Transfer Certificate (BPTC), Bill of lading/Air Waybill, Certificate of Analysis (COA), Delivery Docket/Manifest, Export clearance documentation	
Net Weight (Kilograms)	Usually encoded in the GS1 barcode, the Net Weight is a variable measure of the trade item e.g., carton, pallet or shipment recorded in kilograms.	Yes	Bill of lading/Air Waybill, Meat Messaging Consignment Report	For more information visit the GS1 website.
Order date	This is the date on which the purchase order or contract was raised by the buyer.	Yes	Delivery Docket/Manifest	
Packaging Date	Encoded in the GS1 barcode, the Packaging Date is the date on which the item was packaged and is recorded in the format year, month, day (YYMMDD).	Yes	Certificate of Analysis (COA)	For more information visit the GS1 website.
Packaging Date Range	This includes the oldest and newest packaging dates for the logistic unit.	Yes	Export clearance documentation	
Pallet Serial Shipping Container Code (SSCC)	Encoded in the GS1 barcode, this is a unique number which identifies the individual logistic unit i.e., pallet that is assigned by the establishment constructing the unit. The SSCC remains the same for the life of the logistic unit.	Yes	Animal By Product Transfer Certificate (BPTC), Export clearance documentation, Meat Messaging Consignment Report	For more information visit the GS1 website.
Production Date (YYMMDD)	Encoded in the GS1 barcode, this is the 'kill' or slaughter' date of the product and is recorded in the format year, month, day (YYMMDD).	Yes	Animal By Product Transfer Certificate (BPTC), Certificate of Analysis (COA)	For more information visit the GS1 website.
Recipient Australian Business Number (ABN)	This is an 11-digit registration number, issued by the Australian Tax Office, used to identify businesses.	Yes	Receipt of purchase/Tax Invoice	For more information visit the ATO website.
Seal Serial Number	This is a unique serial number printed on any tamper-evident seal issued by the Department.	Yes	Animal By Product Transfer Certificate (BPTC), Bill of	For more information visit the GS1 website.

			lading/Air Waybill, Export clearance documentation	
Seller/Supplier Australian Business Number (ABN)	This is an 11-digit registration number, issued by the Australian Tax Office, used to identify businesses.	Yes	Receipt of purchase/Tax Invoice	For more information visit the ATO website.
Shipping Mark	Also known as a port mark, this is a code comprising of three letters representing the foreign establishment number and the last nine digits of the consignment SSCC.	Yes	Bill of lading/Air Waybill, Certificate of Analysis (COA), Delivery Docket/Manifest, Meat Messaging Consignment Report	
To Establishment number	A number issued by Federal and State Authorities to identify the originating site from which meat or meat products were distributed to domestic or export markets. For transfer certificates, the Establishment numbers for both the dispatching and receiving establishments are recorded.	Yes	Animal By Product Transfer Certificate (BPTC), Export clearance documentation	
Trade description	This is a collective set of words that says what the product is and may include information such as species, net weight of product, name and address of establishments, category ciphers, market endorsements, MSA eating quality etc.	Yes	Animal By Product Transfer Certificate (BPTC), Delivery Docket/Manifest, Export clearance documentation, Meat Messaging Consignment Report	
Transfer Certificate number	A unique certificate number issued for traceability purposes.	Yes	Animal By Product Transfer Certificate (BPTC), Meat Messaging Consignment Report	For more information visit the Department of Agriculture, Water and the Environment website.
Transport registration number	The registration number of the vehicle in which the animals or product were transported. For shipments of product this will be a shipping container number.	Yes	Animal By Product Transfer Certificate (BPTC), Bill of lading/Air Waybill, Delivery Docket/Manifest, Export clearance documentation, Meat Messaging Consignment Report	

5.2.4.3.5 Regulatory and Industry Programs

- State food authority
- Department of Agriculture
- AUS-MEAT
- Meat Messaging
- Other data sources

5.2.4.3.6 Supply Chain Node Traceability

The traceability of rendered and hide product, that is bulk transported, back to the live animal and property of origin is operationally impractical. This is because rendered and hide products are bulk processed and packaged from any given processing day or number of processing days. While this means that the production date or kill date of animals from which hides or rendered product is likely to be known, any batch of product being packaged into store bags or pallets with unique serialised labels is only traceable to any number of animals or source properties.

For example, hides or product for render which make up one batch come from a total of 6 plant kill day combinations. For each processing day 800 animals, sourced from 8 different properties are slaughtered and the unique serialised NLIS ID tag numbers known for each animal as well as that of the corresponding carcase ticket. With render or hide products from these processing days being processed and packaged in one batch, the unique serialised identifiers of output products can be linked only to that batch and the processing dates from which product was obtained. This means that one batch is comprised of any of 4 800 source animals that were supplied by any of 48 source properties.

All bulk transported products must be accompanied by a Meat Messaging Consignment Report and an Animal By Product Transfer Certificate (BPTC). The Consignment Report is issued to the buyer of product and lists all the logistic unit and subunit unique serialised identifiers contained within the Container System Unit to be exported including the Consignment Serial Shipping Container Code (SCC), Pallet Serial Shipping Container Code, and scanned and verified carton label serial identifiers. Additionally, the Transfer Certificate details the serialised logistic unit identifiers such as the Serial Shipping Container Code (SSCC). These documents allow traceability of the unit and its subunits back to any number of animals or source properties.

5.2.4.3.7 Data flow diagrams

Table 103. Data flow diagrams for the inputs and outputs of a small stock bulk transport system.

Direction	Description
Input	Hides to Bulk loadout
Input	Tallow to Bulk loadout
Input	Meat meal to Bulk loadout

5.2.4.3.7.1 Hides to Bulk loadout

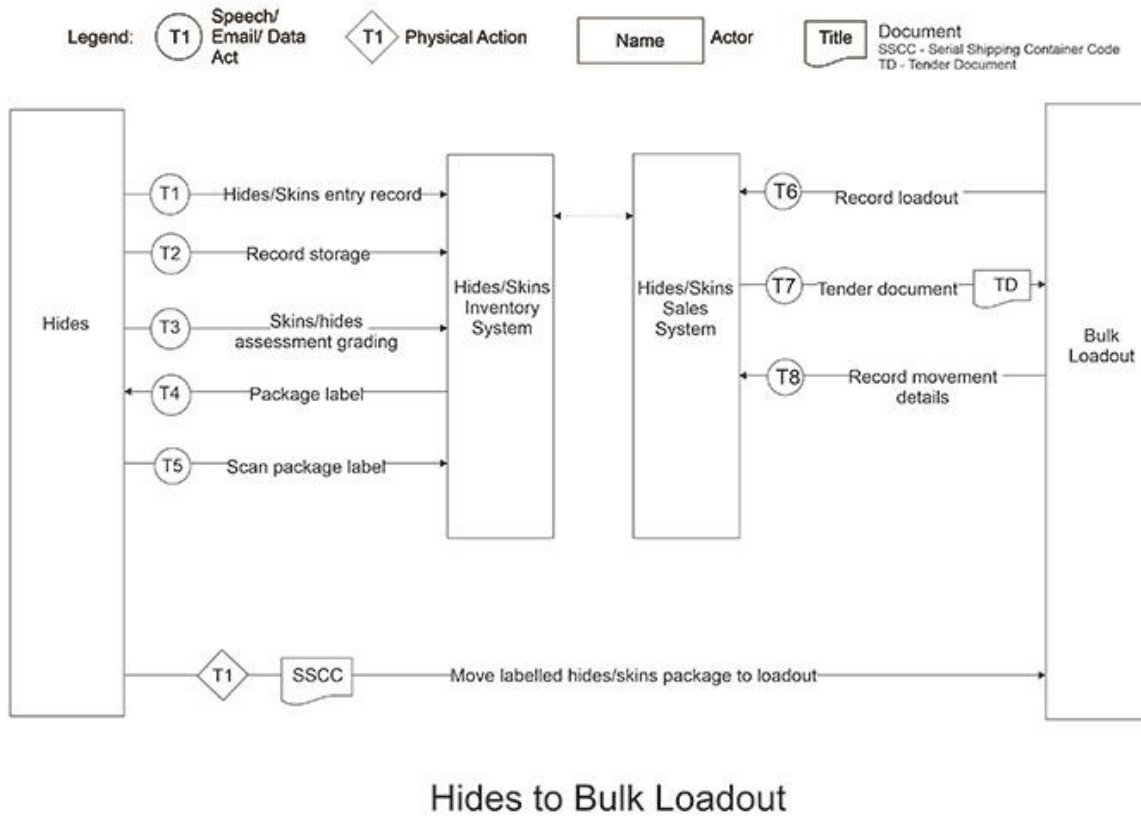
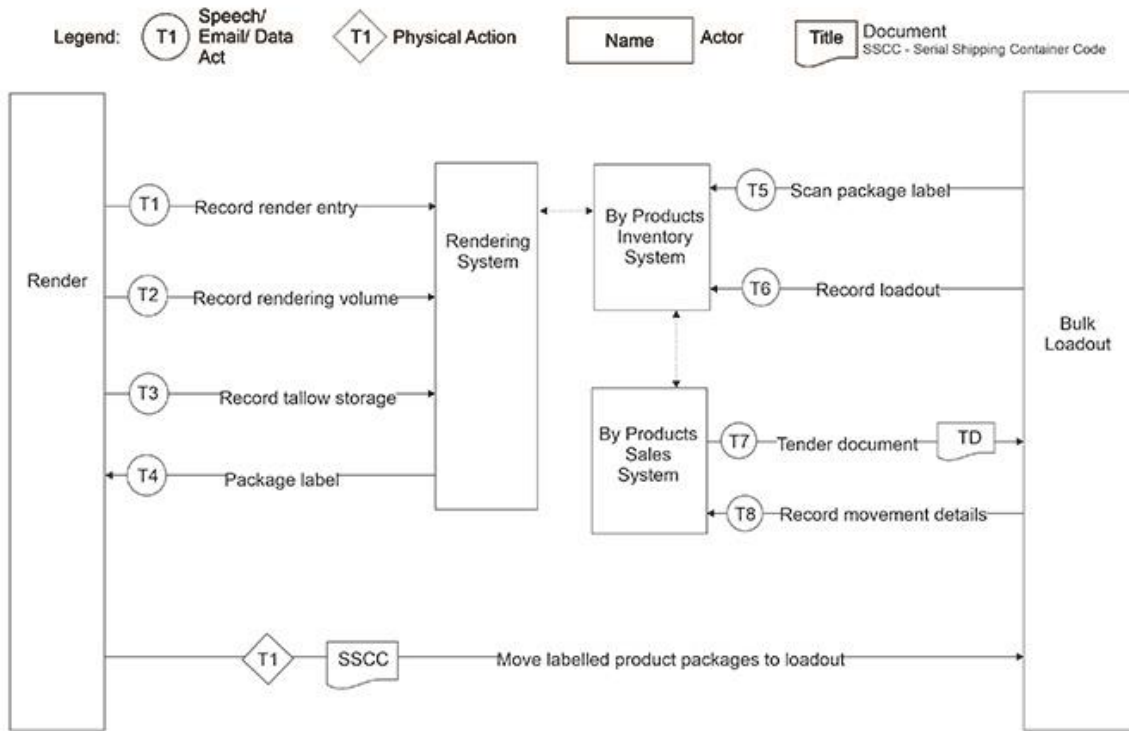

Figure 119. Data or information flows from the hides to bulk loadout systems in the small stock supply chain.

5.2.4.3.7.2 Tallow to Bulk loadout



Tallow to Bulk Loadout

Figure 120. Data or information flows from the tallow to bulk loadout systems in the small stock supply chain.

5.2.4.3.7.3 Meat meal to Bulk loadout

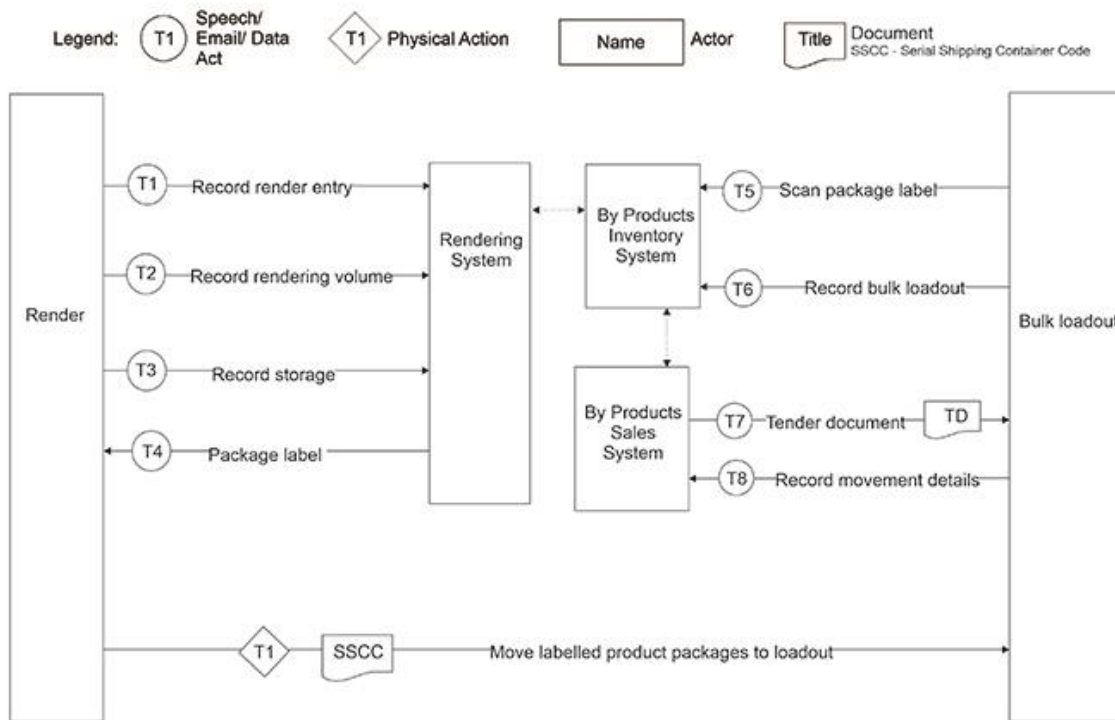

Meat Meal to Bulk Loadout

Figure 121. Data or information flows from the meat meal to bulk loadout systems in the small stock supply chain.

5.2.5 International Trade

5.2.5.1 Live export

Once livestock have completed feeding regimens, they are either sent to slaughter, with product being distributed domestically or exported or sent overseas by boat or airfreight in a process known as live exporting. Australia is one of the world leaders in animal welfare practices and these are ensured through strict standards and regulations that are applied throughout the live animal value chain, including the live export process. As a result, these standards ensure that animals are delivered to the import destination in as best condition as possible.

The live export process is made up of pre-export planning, export, and discharge of the animals at their final destination. Pre-export planning includes government approval for export to an export destination, an approved loading plan, vendor declarations, inspections of the vessel by AQIS (Australian Quarantine and Inspection Service), licensing, inspection of animals both by veterinarians, AQIS, and a stock inspector, export approval, and meeting the requirements for both stockman and veterinarian onboard. The livestock are prepared for transport, assembled to embark, and loaded into the vessel (either ship or plane) for export. Upon arrival, the animals are inspected and signed off on their health before being unloaded.

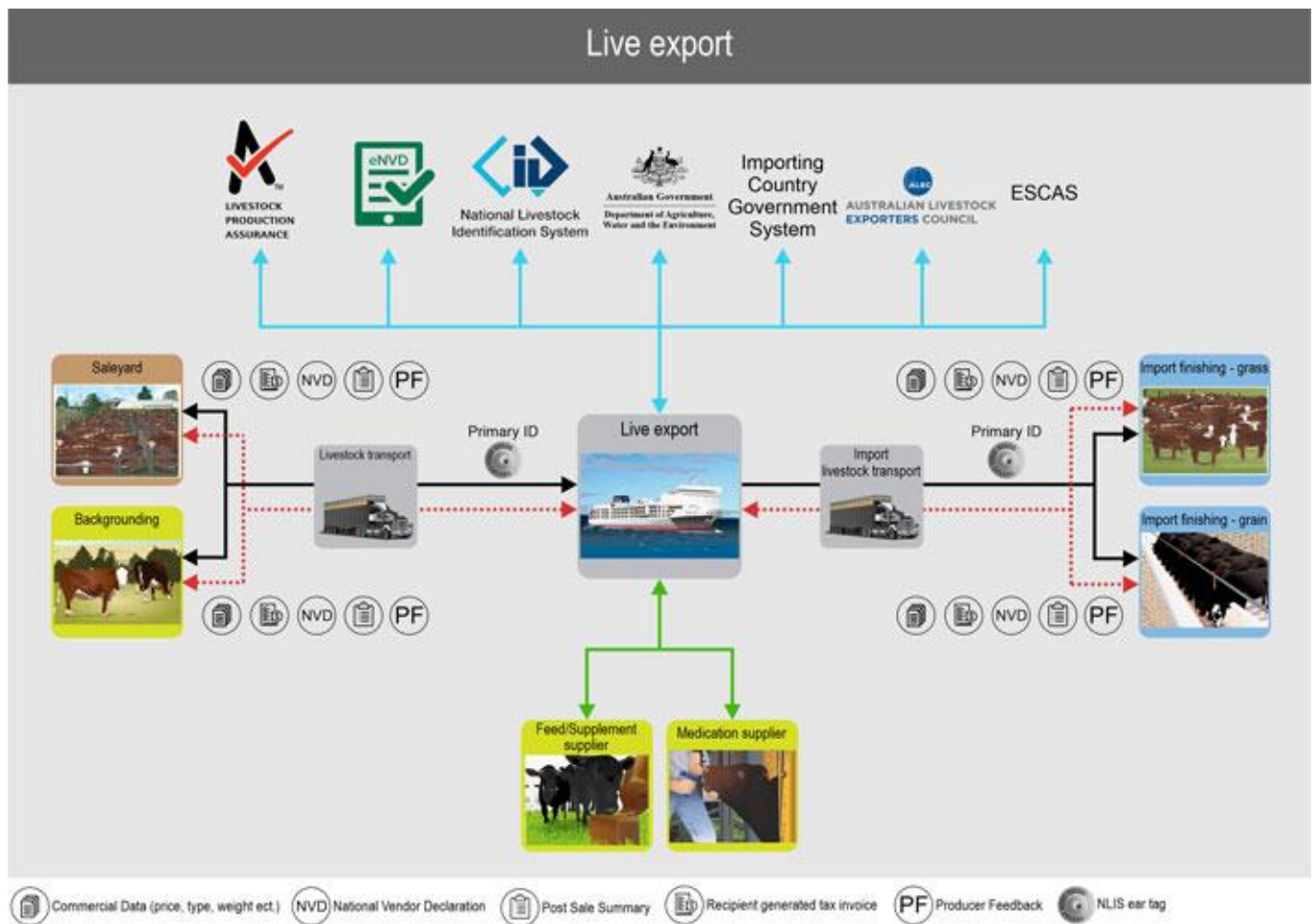

Figure 122. Inputs and outputs of the small stock supply chain live export sector.

5.2.5.1.1 Physical Inputs including Critical Tracking Events (CTEs)

Live export is a complicated process requiring a number of considerations and inputs to make everything run efficiently while keeping the animal's health and wellbeing in mind. Key inputs include the small livestock to be exported, veterinary and other expert services, veterinary drugs, and other health treatments as well as feed supplies and supplements including water. There are many documents required for the Critical Tracking of live export Events and this may include the Bill of lading/Air Waybill, Importer/Exporter Agreement, Livestock Export Health Certificate, NVD and Livestock Export Permit.

Critical Tracking Events (CTEs) are defined as those events which include the growing, receiving, transforming, creating, and shipping of food products. Such events are critical to the traceability of product throughout the supply chain.

The CTEs associated with inputs to the live export system include the receipt of:

- Small livestock
- Experts and veterinarians
- Veterinary drugs or other health treatments
- Feed supplies and supplements.

Table 104. Physical inputs and associated Critical Tracking Event related documents for a small stock live export system.

Event related to the inputs	Description of the inputs	Critical Tracking Event (CTE) related documents (including electronic)	More details
Small livestock	These are sheep or goat livestock and may include any class of animals e.g., weaners, ewe/nanny, ram/buck, cull livestock etc.	Bill of lading/Air Waybill, Exporter/Importer Agreement, Feed and water record, Livestock Export Health Certificate, Livestock Export Licence, Livestock Export Permit, MSA Declaration, NFAS Agents Declaration, NFAS Delivery Docket or Form B, NLIS Movement Update, NVD, Post Sale Summary, Pregnancy Test Report, Receipt of purchase/Tax Invoice, State specific movement forms	
Experts and veterinarians	These are professionals who provide services to the breeding enterprise which ensure the safety, wellbeing, and productivity of the livestock.	Receipt of purchase/Tax Invoice, Veterinary prescription	
Veterinary drugs or other health treatments	These may be prescribed, or non-prescribed treatments or medications given to ensure the health and wellbeing of the livestock.	Receipt of purchase/Tax Invoice, Veterinary prescription	
Feed supplies and supplements	These are supplementary animal feed products such as hay or silage fodder, or mineral supplements which are provided to ensure the production efficiency and health of livestock are maintained. This may also include clean drinking water e.g., where livestock are in transit or at saleyards.	Commodity Vendor Declaration (CVD), Receipt of purchase/Tax Invoice	

5.2.5.1.2 Information Inputs including Key Data Elements (KDEs)

Key Data Elements (KDEs) are defined as those elements which are key in identifying and tracing the Critical Tracking Event (CTE). There are many KDEs which can be found on CTE documentation associated with live exports. For example, these may include agreement, movement, and quarantine dates, To and From PICs, To and From Port Codes as well as document identification and licence numbers.

Table 105. Information inputs, Key Data Elements and Critical Tracking Event related documentation for a small stock live export system.

Attributes (including KDEs)	Description of the Attributes (including KDEs)	Is a KDE	Critical Tracking Event (CTE) related documents (including electronic)	More details
APVMA approval number	This is a unique number allocated to each label by the APVMA.	Yes	Commodity Vendor Declaration, Livestock Export Health Certificate, NVD	For more information visit the Australian Pesticides and Veterinary Medicine Authority.
Authorised Officer Identity Number	A unique number issued to Australian Government	Yes	Livestock Export Permit	For more information visit the Department

	Authorised Officers for identification purposes.			of Agriculture, Water and the Environment website.
Batch number	This is a unique number which identifies products sharing certain production characteristics and is used for traceability purposes.	Yes	Commodity Vendor Declaration, Livestock Export Health Certificate, NVD	
Bill of lading/Air Waybill document number	A unique document number issued for traceability purposes.	Yes	Bill of lading/Air Waybill	
Company/product code	This is an in-house code for the identification of the product in the unit.	Yes	Feed and water record, Receipt of purchase/Tax Invoice	
Contract number	This is a unique number allocated to the contract by the seller.	Yes	Commodity Vendor Declaration, Exporter/Importer Agreement	
Count of Trade Items	Usually encoded in the GS1 barcode, this is the number of trade items e.g., cartons in the logistic unit.	Yes	Bill of lading/Air Waybill	
Date	This is the date of signing or of which a record entry or transaction was made.	Yes	Bill of lading/Air Waybill, Commodity Vendor Declaration, Exporter/Importer Agreement, Feed and water record, Livestock Export Health Certificate, Livestock Export Permit, MSA Declaration, NFAS Agents Declaration, NFAS Delivery Docket or Form B, NVD, Post Sale Summary, Pregnancy Test Report, Receipt of purchase/Tax Invoice, State specific movement forms	
Export Health Certificate Number	A unique number allocated to the health certificate issued for the export consignment for traceability purposes.	Yes	Livestock Export Health Certificate	For more information visit the Department of Agriculture, Water and the Environment website.
Export Premises Registration number	A unique number issued to Australian Government approved quarantine premises where livestock are prepared for export.	Yes	Livestock Export Health Certificate	For more information visit the Department of Agriculture, Water and the Environment website.
From PIC	The Property Identification Code from/to where the livestock or product were consigned.	Yes	Commodity Vendor Declaration, MSA Declaration, NFAS Delivery Docket or Form B, NLIS Movement	For more information visit the Integrity systems website.

			Update, NVD, Post Sale Summary, State specific movement forms	
From Port Code	Any location used in international trade and transport (e.g., seaport, airports etc.) are issued with an identification code.	Yes	Livestock Export Health Certificate, Livestock Export Permit	For more information visit the Integrity systems website.
Livestock Export Licence Holder number	A unique licence number is allocated to exporters of livestock for a period of one to five years following submission of a correct documentation which is then approved by the Secretary.	Yes	Exporter/Importer Agreement, Livestock Export Health Certificate, Livestock Export Licence, Livestock Export Permit	For more information visit the Integrity systems website.
Livestock Export Permit Number	A unique permit number is allocated for the export of a livestock consignment following submission of a correct and validated Notice of Intention (NOI), Exporter Supply Chain Assurance System (ESCAS) application and other documentation which is then approved by the Secretary.	Yes	Livestock Export Permit	For more information visit the Integrity systems website.
Movement date	The date on which livestock or other products (e.g., feed or meat products) were transported between PICs/establishments.	Yes	Bill of lading/Air Waybill, Commodity Vendor Declaration, Exporter/Importer Agreement, Livestock Export Health Certificate, MSA Declaration, NFAS Agents Declaration, NFAS Delivery Docket or Form B, NLIS Movement Update, NVD, State specific movement forms	
Movement time	This is the time at which livestock were moved from the property (PIC) of origin. Direct consignments travelling to processors by road must be slaughtered with 48 hours of dispatch.	Yes	MSA Declaration	
MSA Declaration Serial Number	Each MSA Declaration form has a unique serial number.	Yes	MSA Declaration	For more information on MSA visit the MLA website.
MSA Licence Number	Any establishment consigning, supplying, or identifying MSA Certified Product must be registered and have a unique MSA Licence Number.	Yes	MSA Declaration, Receipt of purchase/Tax Invoice	For more information on MSA visit the MLA website.
National Grower Registration Number	A unique number assigned to individuals registered with the National Grower Register, an online business register for Australian growers.	Yes	Commodity Vendor Declaration	

Net Weight (Kilograms)	Usually encoded in the GS1 barcode, the Net Weight is a variable measure of the trade item e.g., carton, pallet or shipment recorded in kilograms.	Yes	Bill of lading/Air Waybill	
NFAS Accreditation Number	This is a unique number given to accredited feedlots certified under the National Feedlot Accreditation Scheme (NFAS).	Yes	NFAS Delivery Docket or Form B	For more information visit the AUS-MEAT website.
NFAS Delivery Docket Number	Each NFAS document has a unique number or identity code.	Yes	NFAS Agents Declaration	For more information visit the AUS-MEAT website.
NLIS Tag Number/RFID	All animals transported between PICs must have a permanent National Livestock Identification System tag attached. This tag has a unique animal identification number.	Yes	Bill of lading/Air Waybill, Livestock Export Health Certificate, NLIS Movement Update, Pregnancy Test Report	For more information visit the Integrity systems website.
NVD Serial Number	Each NVD form has a unique serial number.	Yes	NFAS Delivery Docket or Form B, NLIS Movement Update, NVD, Post Sale Summary, Pregnancy Test Report	For more information visit the Integrity systems website.
Official mark	Any stamp, seal, label, or mark that is declared by the regulations to be an official mark. An official mark signifies that the product has been inspected by and approved as safe for human consumption by an Authorised Officer.	Yes	Livestock Export Permit	For more information visit the Department of Agriculture, Water and the Environment website.
Prescription number	A unique certificate number issued for traceability purposes.	Yes	Veterinary prescription	
Producer/Vendor MSA Registration Number	Producers consigning livestock to MSA markets are required to be registered and have a unique MSA Registration Number.	Yes	MSA Declaration	For more information on MSA visit the MLA website.
Product code/description	This is a unique identifier or description assigned by the seller to each product type marketed or for sale.	Yes	Commodity Vendor Declaration	
Quality Assurance Officer (QAO) Certificate Number	A unique number issued to personnel issued with a Statement of Authority for demonstrating skills for compliance with meeting NFAS Rules and Standards.	Yes	NFAS Delivery Docket or Form B	For more information visit the AUS-MEAT website.
Quarantine date range	This is the date range identifying a period in time in which livestock were	Yes	Livestock Export Health Certificate	For more information visit the Department

	quarantined directly prior to exportation.			of Agriculture, Water and the Environment website.
Recipient Australian Business Number (ABN)	This is an 11-digit registration number, issued by the Australian Tax Office, used to identify businesses.	Yes	Feed and water record, Receipt of purchase/Tax Invoice	For more information visit the ATO website.
Seller/Supplier Australian Business Number (ABN)	This is an 11-digit registration number, issued by the Australian Tax Office, used to identify businesses.	Yes	Feed and water record, Receipt of purchase/Tax Invoice	For more information visit the ATO website.
Shipping Mark	Also known as a port mark, this is a code comprising of three letters representing the foreign establishment number and the last nine digits of the consignment SSCC.	Yes	Bill of lading/Air Waybill	
Supply Chain Number (SCN)	A number allocated to approved applications for the exportation of live animals. These applications have met transportation, handling, slaughter, and other requirements under the Exporter Supply Chain Assurance System (ESCAS) system.	Yes	Livestock Export Permit	For more information visit the Department of Agriculture, Water and the Environment website.
To PIC	The Property Identification Code from/to where the livestock or product were consigned.	Yes	Commodity Vendor Declaration, NLIS Movement Update, NVD, Post Sale Summary, State specific movement forms	For more information visit the Integrity systems website.
To Port Code	Any location used in international trade and transport (e.g., seaport, airports etc.) are issued with an identification code.	Yes	Livestock Export Health Certificate, Livestock Export Permit	For more information visit the Department of Agriculture, Water and the Environment website.
Transport registration number	The registration number of the vehicle in which the animals or product were transported. For shipments of product this will be a shipping container number.	Yes	Bill of lading/Air Waybill, Livestock Export Health Certificate, NVD	
Treatment date	The date on which a treatment or product was applied to a unit e.g., paddock, animal, fodder etc.	Yes	Commodity Vendor Declaration, Feed and water record, Livestock Export Health Certificate, NVD	

Veterinary Registration Number	A unique number issued to veterinarians who are registered to practice, under the state legislative requirements, within the state in which they reside.	Yes	Livestock Export Health Certificate, Pregnancy Test Report, Veterinary prescription	
--------------------------------	--	-----	---	--

5.2.5.1.3 Physical Outputs including Critical Tracking Events (CTEs)

Key outputs of the live export process are limited to the animals themselves. There are many documents required for the Critical Tracking of live export Events and this may include the Bill of lading/Air Waybill, Importer/Exporter Agreement, Livestock Export Health Certificate, NVD and Livestock Export Permit. On arrival at the port of the importing country, animals typically undergo inspection by quarantine officers. Here a document such as the Veterinary Services Form/Import release is signed off before animals are released to the importer.

Critical Tracking Events (CTEs) are defined as those events which include the growing, receiving, transforming, creating, and shipping of food products. Such events are critical to the traceability of product throughout the supply chain.

The CTEs associated with the outputs of the live export system include the movement of:

- Small livestock

off the property, premises, or supply chain sector.

Table 106. Physical outputs and associated Critical Tracking Event related documents for a small stock live export system.

Event related to the inputs	Description of the inputs	Critical Tracking Event (CTE) related documents (including electronic)	More details
Small livestock	These are sheep or goat livestock and may include any class of animals e.g., weaners, ewe/nanny, ram/buck, cull livestock etc.	Bill of lading/Air Waybill, Exporter/Importer Agreement, Feed and water record, Import Permit, Livestock Export Health Certificate, Livestock Export Licence, Livestock Export Permit, MSA Declaration, NLIS Movement Update, NVD, Post Sale Summary, Pregnancy Test Report, Receipt of purchase/Tax Invoice, State specific movement forms, Veterinary Services Form/Import release	

5.2.5.1.4 Information Outputs including Key Data Elements (KDEs)

Key Data Elements (KDEs) are defined as those elements which are key in identifying and tracing the Critical Tracking Event (CTE). There are many KDEs which can be found on CTE documentation associated with live exports. For example, these may include agreement, movement, and quarantine dates, To and From PICs, To and From Port Codes as well as document identification and licence numbers.

Table 107. Information outputs, Key Data Elements and Critical Tracking Event related documentation for a small stock live export system.

Attributes (including KDEs)	Description of the Attributes (including KDEs)	Is a KDE	Critical Tracking Event (CTE) related documents (including electronic)	More details

APVMA approval number	This is a unique number allocated to each label by the APVMA.	Yes	Livestock Export Health Certificate, NVD	For more information visit the Australian Pesticides and Veterinary Medicine Authority.
Authorised Officer Identity Number	A unique number issued to Australian Government Authorised Officers for identification purposes.	Yes	Livestock Export Permit	For more information visit the Department of Agriculture, Water and the Environment website.
Batch number	This is a unique number which identifies products sharing certain production characteristics and is used for traceability purposes.	Yes	Livestock Export Health Certificate, NVD	
Bill of lading/Air Waybill document number	A unique document number issued for traceability purposes.	Yes	Bill of lading/Air Waybill	
Company/product code	This is an in-house code for the identification of the product in the unit.	Yes	Feed and water record, Receipt of purchase/Tax Invoice	
Contract number	This is a unique number allocated to the contract by the seller.	Yes	Exporter/Importer Agreement	
Count of Trade Items	Usually encoded in the GS1 barcode, this is the number of trade items e.g., cartons in the logistic unit.	Yes	Bill of lading/Air Waybill	
Customs Entry number	A unique number assigned to an entry document and issued to importation shipments by customs for identification purposes.	Yes	Veterinary Services Form/Import release	
Date	This is the date of signing or of which a record entry or transaction was made.	Yes	Bill of lading/Air Waybill, Exporter/Importer Agreement, Feed and water record, Livestock Export Health Certificate, Livestock Export Permit, MSA Declaration, NFAS Agents Declaration, NFAS Delivery Docket or Form B, NVD, Post Sale Summary, Pregnancy Test Report, Receipt of purchase/Tax Invoice, State specific movement forms, Veterinary Services Form/Import release	
Export Health Certificate Number	A unique number allocated to the health certificate issued for the export consignment for traceability purposes.	Yes	Livestock Export Health Certificate	For more information visit the Department of

				Agriculture, Water and the Environment website.
Export Premises Registration number	A unique number issued to Australian Government approved quarantine premises where livestock are prepared for export.	Yes	Livestock Export Health Certificate	For more information visit the Department of Agriculture, Water and the Environment website.
From PIC	The Property Identification Code from/to where the livestock or product were consigned.	Yes	MSA Declaration, NFAS Delivery Docket or Form B, NLIS Movement Update, NVD, Post Sale Summary, State specific movement forms	For more information visit the Integrity systems website.
From Port Code	Any location used in international trade and transport (e.g., seaport, airports etc.) are issued with an identification code.	Yes	Livestock Export Health Certificate, Livestock Export Permit	For more information visit the Department of Agriculture, Water and the Environment website.
Import Permit Number	A unique permit number is allocated for the import consignment following submission of correct and validated documentation approved by the importing country.	Yes	Import Permit, Veterinary Services Form/Import release	For more information visit the Department of Agriculture, Water and the Environment website.
Livestock Export Licence Holder number	A unique licence number is allocated to exporters of livestock for a period of one to five years following submission of a correct documentation which is then approved by the Secretary.	Yes	Exporter/Importer Agreement, Livestock Export Health Certificate, Livestock Export Licence, Livestock Export Permit	For more information visit the Department of Agriculture, Water and the Environment website.
Livestock Export Permit Number	A unique permit number is allocated for the export of a livestock consignment following submission of a correct and validated Notice of Intention (NOI), Exporter Supply Chain Assurance System (ESCAS) application and other documentation which is then approved by the Secretary.	Yes	Livestock Export Permit	For more information visit the Department of Agriculture, Water and the Environment website.
Movement date	The date on which livestock or other products (e.g., feed or meat products) were	Yes	Bill of lading/Air Waybill, Exporter/Importer Agreement, Livestock Export Health Certificate,	

	transported between PICs/establishments.		MSA Declaration, NFAS Agents Declaration, NFAS Delivery Docket or Form B, NLIS Movement Update, NVD, State specific movement forms, Veterinary Services Form/Import release	
Movement time	This is the time at which livestock were moved from the property (PIC) of origin. Direct consignments travelling to processors by road must be slaughtered with 48 hours of dispatch.	Yes	MSA Declaration	
MSA Declaration Serial Number	Each MSA Declaration form has a unique serial number.	Yes	MSA Declaration	For more information on MSA visit the MLA website.
MSA Licence Number	Any establishment consigning, supplying, or identifying MSA Certified Product must be registered and have a unique MSA Licence Number.	Yes	MSA Declaration, Receipt of purchase/Tax Invoice	For more information on MSA visit the MLA website.
Net Weight (Kilograms)	Usually encoded in the GS1 barcode, the Net Weight is a variable measure of the trade item e.g., carton, pallet or shipment recorded in kilograms.	Yes	Bill of lading/Air Waybill	
NFAS Accreditation Number	This is a unique number given to accredited feedlots certified under the National Feedlot Accreditation Scheme (NFAS).	Yes	NFAS Delivery Docket or Form B	For more information visit the AUS-MEAT website.
NFAS Delivery Docket Number	Each NFAS document has a unique number or identity code.	Yes	NFAS Agents Declaration	For more information visit the AUS-MEAT website.
NLIS Tag Number/Rfid	All animals transported between PICs must have a permanent National Livestock Identification System tag attached. This tag has a unique animal identification number.	Yes	Bill of lading/Air Waybill, Livestock Export Health Certificate, NLIS Movement Update, Pregnancy Test Report	For more information visit the Integrity systems website.
NVD Serial Number	Each NVD form has a unique serial number.	Yes	NFAS Delivery Docket or Form B, NLIS Movement Update, NVD, Post Sale Summary, Pregnancy Test Report	For more information visit the Integrity systems website.
Official mark	Any stamp, seal, label, or mark that is declared by the regulations to be an official mark. An official mark signifies that the product has been inspected by and approved as	Yes	Livestock Export Permit	For more information visit the Department of Agriculture, Water and the

	safe for human consumption by an Authorised Officer.			Environment website.
Producer/Vendor MSA Registration Number	Producers consigning livestock to MSA markets are required to be registered and have a unique MSA Registration Number.	Yes	MSA Declaration	For more information on MSA visit the MLA website.
Quality Assurance Officer (QAO) Certificate Number	A unique number issued to personnel issued with a Statement of Authority for demonstrating skills for compliance with meeting NFAS Rules and Standards.	Yes	NFAS Delivery Docket or Form B	For more information visit the AUS-MEAT website.
Quarantine date range	This is the date range identifying a period in time in which livestock were quarantined directly prior to exportation.	Yes	Livestock Export Health Certificate	For more information visit the Department of Agriculture, Water and the Environment website.
Recipient Australian Business Number (ABN)	This is an 11-digit registration number, issued by the Australian Tax Office, used to identify businesses.	Yes	Feed and water record, Receipt of purchase/Tax Invoice	For more information visit the ATO website.
Seller/Supplier Australian Business Number (ABN)	This is an 11-digit registration number, issued by the Australian Tax Office, used to identify businesses.	Yes	Feed and water record, Receipt of purchase/Tax Invoice	For more information visit the ATO website.
Shipping Mark	Also known as a port mark, this is a code comprising of three letters representing the foreign establishment number and the last nine digits of the consignment SSCC.	Yes	Bill of lading/Air Waybill	
Supply Chain Number (SCN)	A number allocated to approved applications for the exportation of live animals. These applications have met transportation, handling, slaughter, and other requirements under the Exporter Supply Chain Assurance System (ESCAS) system.	Yes	Livestock Export Permit	For more information visit the Department of Agriculture, Water and the Environment website.
To PIC	The Property Identification Code from/to where the livestock or product were consigned.	Yes	NLIS Movement Update, NVD, Post Sale Summary, State specific movement forms	For more information visit the Integrity systems website.
To Port Code	Any location used in international trade and transport (e.g., seaport,	Yes	Livestock Export Health Certificate, Livestock Export Permit, Veterinary Services Form/Import release	For more information visit the Department of

	airports etc.) are issued with an identification code.			Agriculture, Water and the Environment website.
Transport registration number	The registration number of the vehicle in which the animals or product were transported. For shipments of product this will be a shipping container number.	Yes	Bill of lading/Air Waybill, Livestock Export Health Certificate, NVD, Veterinary Services Form/Import release	
Treatment date	The date on which a treatment or product was applied to a unit e.g., paddock, animal, fodder etc.	Yes	Feed and water record, Livestock Export Health Certificate, NVD	
Veterinary Registration Number	A unique number issued to veterinarians who are registered to practice, under the state legislative requirements, within the state in which they reside.	Yes	Livestock Export Health Certificate, Pregnancy Test Report	

5.2.5.1.5 Regulatory and Industry Programs

- Australian Live Exporters Council (ALEC)
- Department of Agriculture
- eNVD
- Exporter Supply Chain Assurance System (ESCAS)
- Importing Country Government System
- Livestock Production Assurance (LPA)
- National Livestock Identification System (NLIS)

5.2.5.1.6 Supply Chain Node Traceability

The National Livestock Identification System (NLIS) is the Australian livestock traceability program which is administered by Integrity Systems Company (ISC). Where stipulated by State legislation and certain export markets, the NLIS system requires all animals bought, sold, and moved along the supply chain to be tagged with an accredited NLIS ID tag. Each tag has an NLIS tag number or Radio Frequency Identifier (RFID) for the traceability of the animal throughout its lifetime. Every property which holds livestock must have a Property Identification Code (PIC) to which the livestock are assigned in the NLIS Database. Each time livestock are transferred between PICs within Australia they must be accompanied by a livestock movement declaration, such as the National Vendor Declaration (NVD) form. This document typically outlines the transporter details, consignment details, compliance with intended market specifications, withholding periods, and the details of the new property PIC. All livestock movements between PICs require an NLIS movement update to be made by either or both the consigner and receiver. Where NLIS ID tags are lost livestock must be issued with a new post-breeder tag if not on the PIC of birth and this reconciled in the NLIS Database. For animals loaded for live export, it is the exporters responsibility to ensure that all livestock are transferred from the port PIC to EEEEEEEE (8Es) which signifies that livestock have been exported. The importer of exported livestock must demonstrate that these livestock remain traceable throughout the supply chain up to the point of slaughter. Livestock must be effectively identified, and all movements recorded to allow traceability back to the property of birth in the exporting country i.e., Australia.

5.2.5.1.7 Data flow diagrams

Table 108. Data flow diagrams for the inputs and outputs of a small stock live export system.

Direction	Description
Input	Saleyard to Live Export
Input	Backgrounding to Live Export
Output	Live Export to Import Finishing (grain)
Output	Live Export to Import Finishing (grass)

5.2.5.1.7.1 Saleyard to Live Export

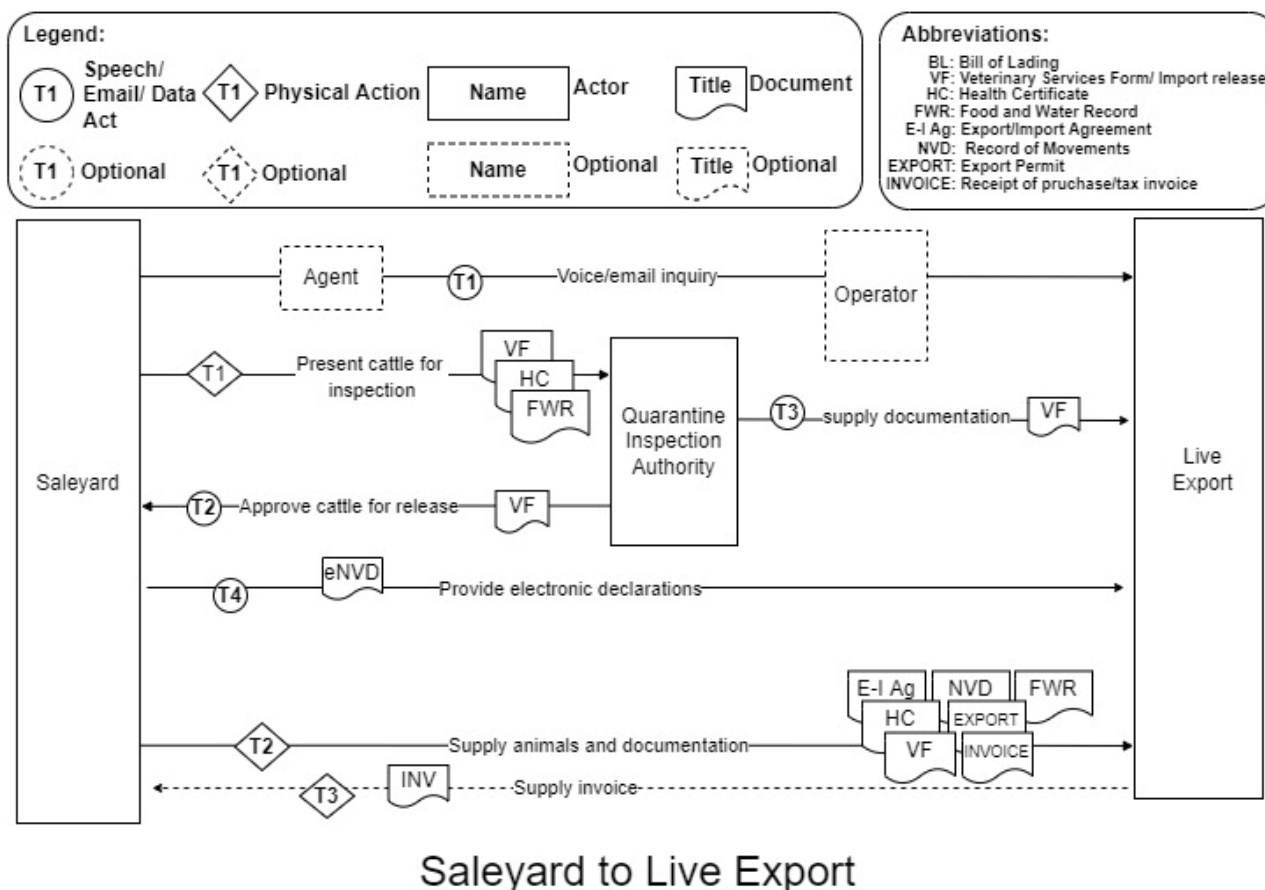

Figure 123. Data or information flows from the saleyard to live export in the small stock supply chain.

5.2.5.1.7.2 Backgrounding to Live Export

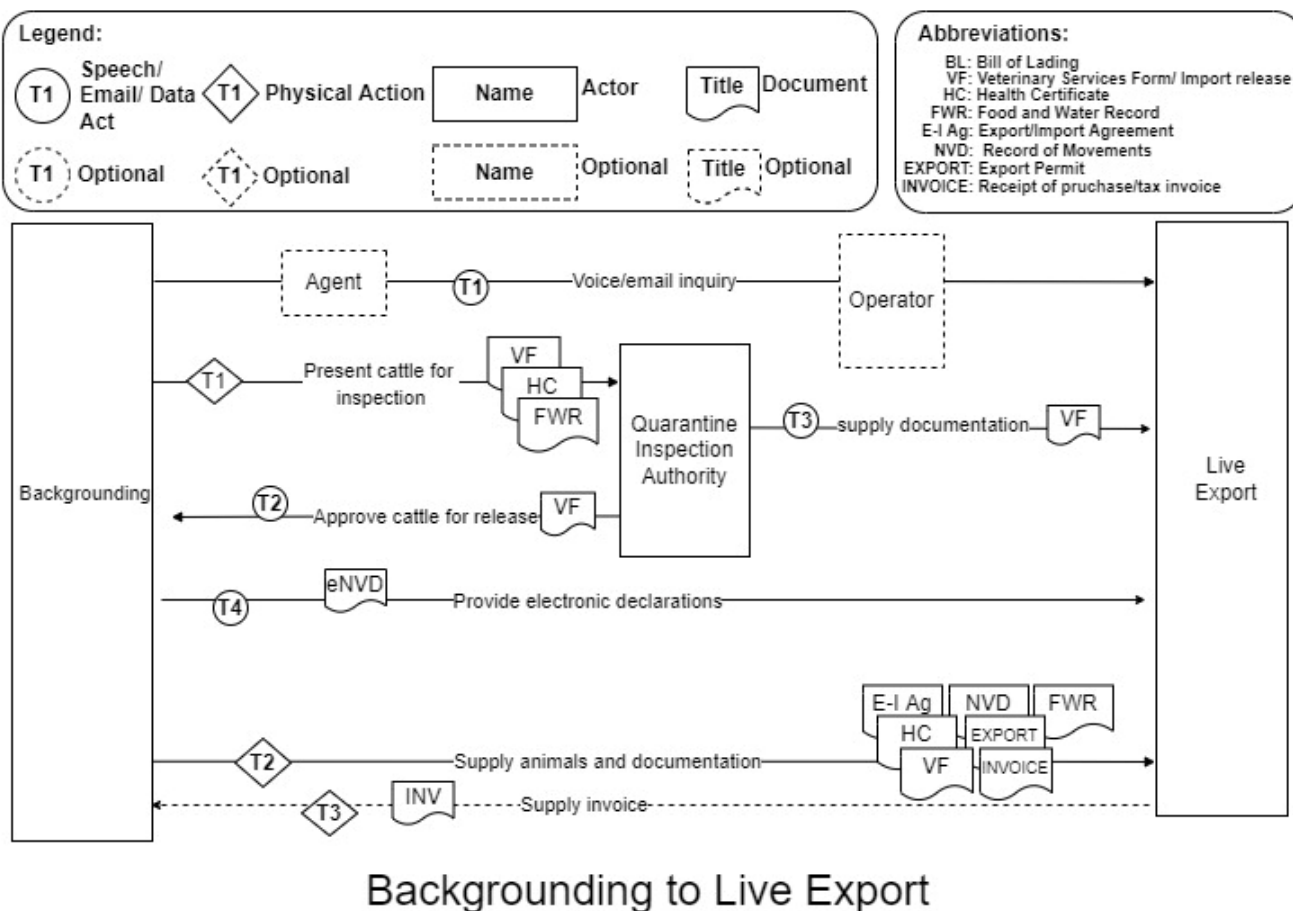
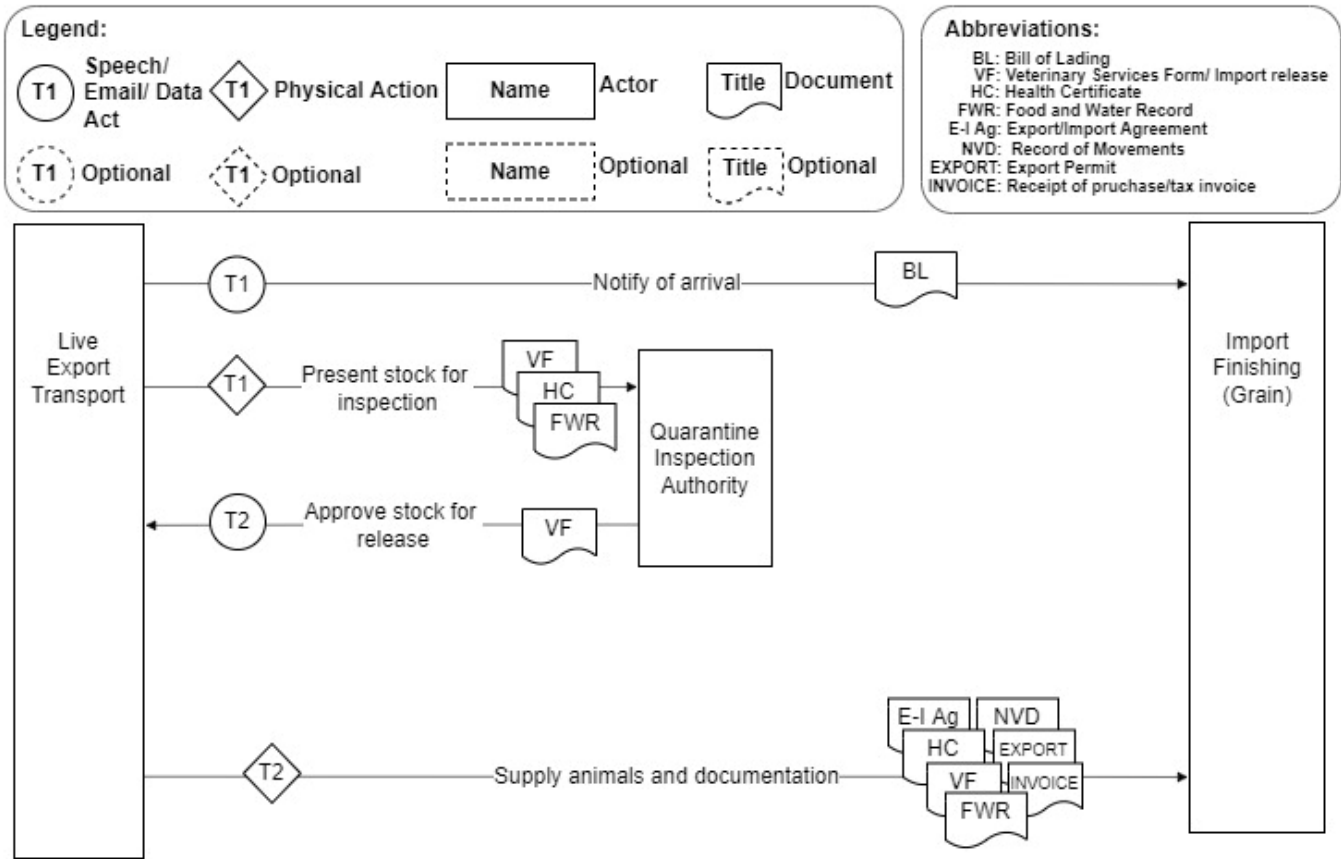

Figure 124. Data or information flows from backgrounding to live export in the small stock supply chain.

5.2.5.1.7.3 Live Export to Import Finishing (grain)



Live Export to Import Finishing (grain)

Figure 125. Data or information flows from live export to import finishing (grain) in the small stock supply chain.

5.2.5.1.7.4 Live Export to Import Finishing (grass)

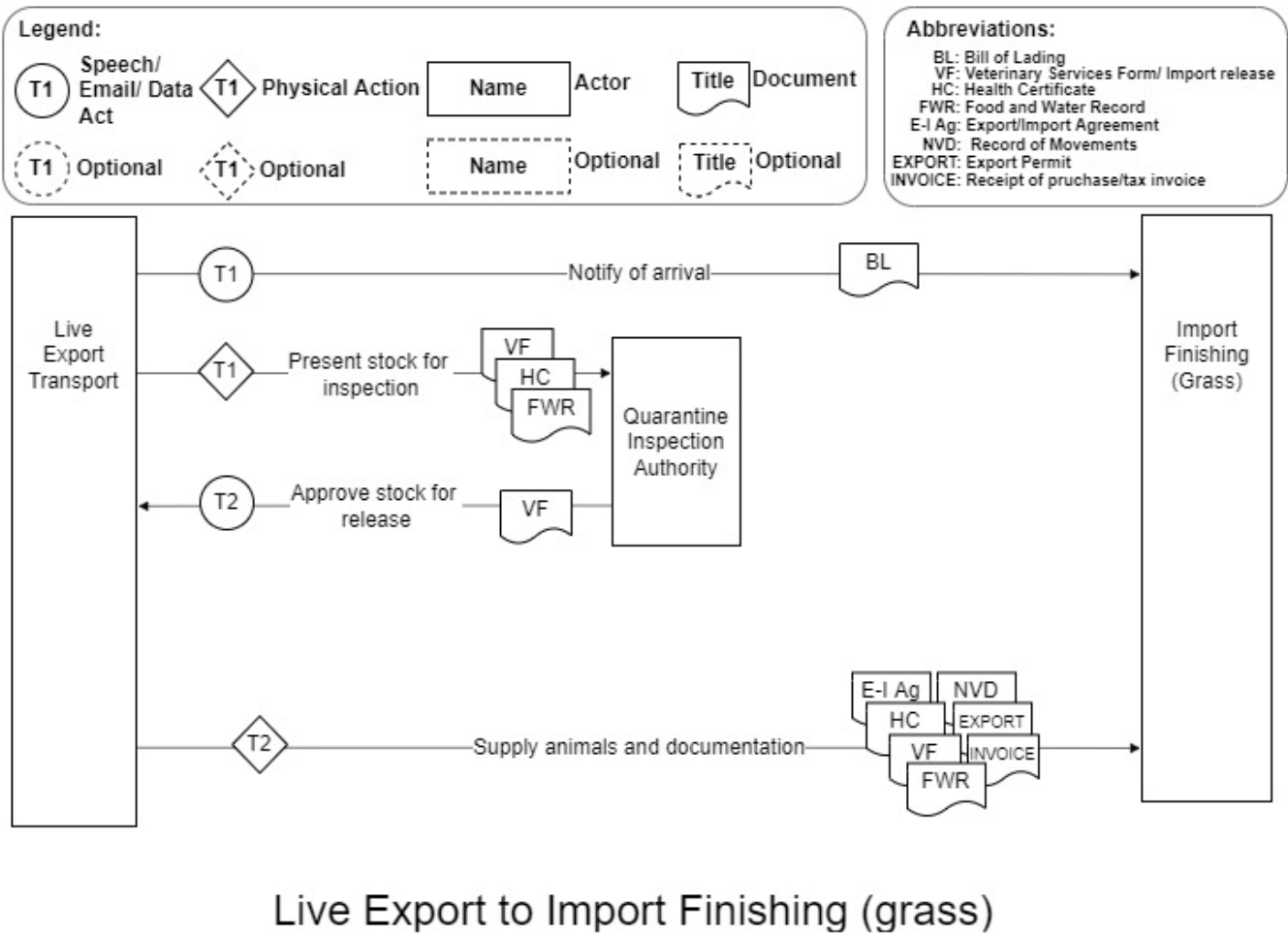

Figure 126. Data or information flows from live export to import finishing (grass) in the small stock supply chain.

5.2.5.2 Non packer exporter

Australia is one of the largest exporters of beef in the world by volume and value of meat and this is largely due to strict animal welfare practices and quality control standards. This has allowed consumer demand for Australian beef to remain strong in a competitive global market against other large exporters such as Brazil and India. Australia principally exports meat to North America, the Middle East, Russia, China, Southeast Asia, Korea and Japan. Non Packer Exporters (NPEs) are holders of a Meat Export Licence who do not operate a premises for the purpose of packaging meat for export registered under the Australian Government Department for Agriculture. NPEs are unable to verify information pertaining to the product but instead work with the packing establishment to ensure product is eligible for export and that all the necessary documentation is organised and approved.

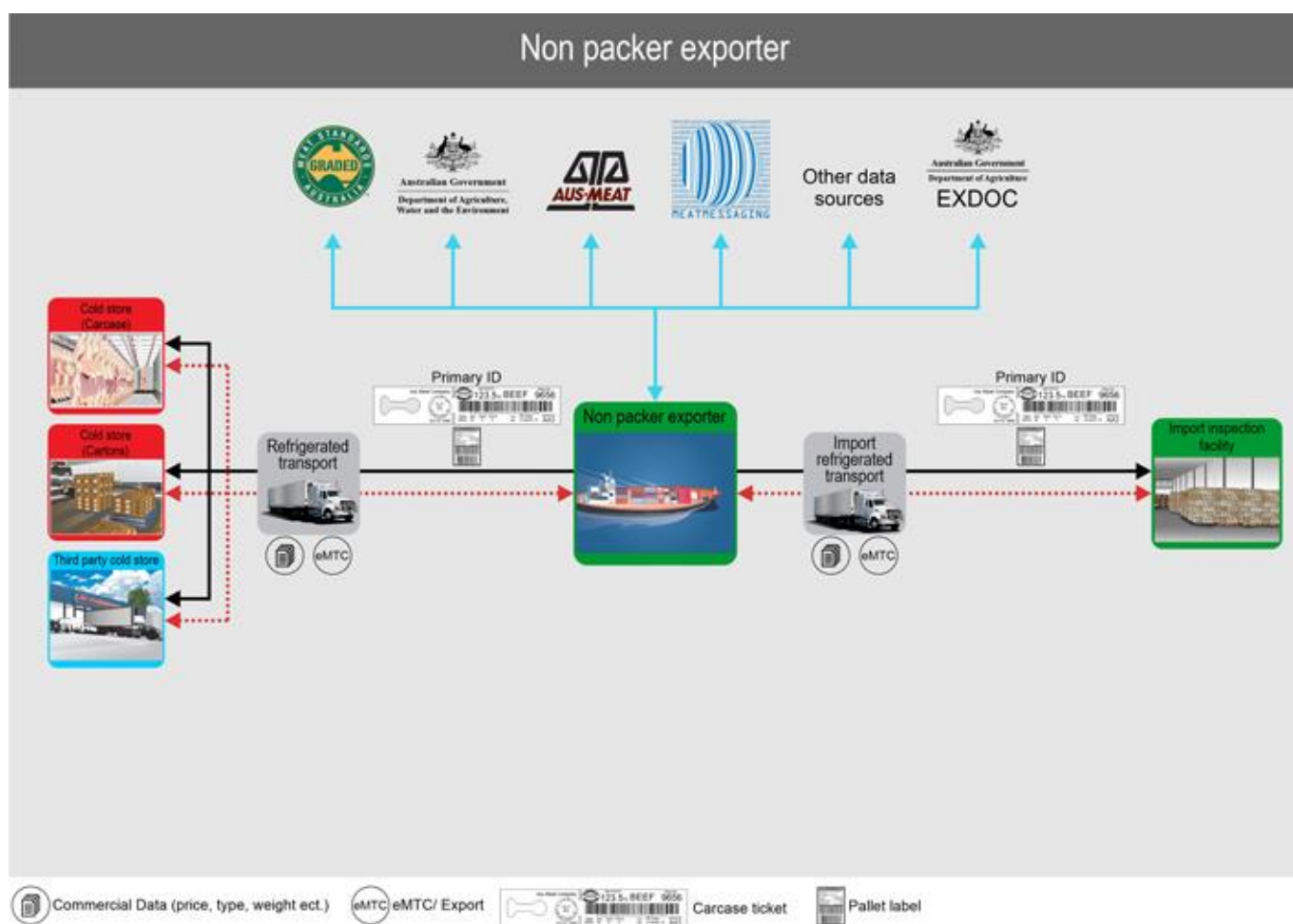

Figure. Inputs and outputs of the small stock supply chain non packer exporter sector.

5.2.5.2.1 Physical Inputs including Critical Tracking Events (CTEs)

NPEs are often buyers and resellers of meat and meat product, organising the documentation associated with the sale and exportation of product. They typically do not see the product; therefore, the inputs into the NPE system are the Critical Tracking Event related documentation. These may include documents such as the Bill of lading/Air Waybill, Export Health Certificate and Certificate of Analysis.

Critical Tracking Events (CTEs) are defined as those events which include the growing, receiving, transforming, creating, and shipping of food products. Such events are critical to the traceability of product throughout the supply chain.

The CTEs associated with inputs to the Non Packer Exporter system include the receipt of:

- Information/ Documentation (meat and meat products Container System Unit).

Table 109. Physical inputs and associated Critical Tracking Event related documents for a small stock non packer exporter system.

Event related to the inputs	Description of the inputs	Critical Tracking Event (CTE) related documents (including electronic)	More details
Information/ Documentation (meat and meat)	As NPEs typically do not see the product, information/documentation includes the Critical Tracking Event	Bill of lading/Air Waybill, Delivery Docket/Manifest, Export Health Certificate, Export Permit, Meat	

products Container System Unit)	related documentation and information required for product movement.	Messaging Consignment Report, Meat Transfer Certificate (MTC), Official seal, Certificate of Analysis (COA), Receipt of purchase/Tax Invoice	
---------------------------------	--	--	--

5.2.5.2.2 Information Inputs including Key Data Elements (KDEs)

Key Data Elements (KDEs) are defined as those elements which are key in identifying and tracing the Critical Tracking Event (CTE). Information inputs into the NPE system are those KDEs which can be drawn from CTE documentation. These may include document numbers for documents such as the Bill of lading/Air Waybill, Meat Transfer Certificate and Certificate of Analysis as well as other product specific information.

Table 110. Information inputs, Key Data Elements and Critical Tracking Event related documentation for a small stock non packer exporter system.

Attributes (including KDEs)	Description of the Attributes (including KDEs)	Is a KDE	Critical Tracking Event (CTE) related documents (including electronic)	More details
Analysis Date	This is the date on which a product sample was analysed.	Yes	Certificate of Analysis (COA)	
Bill of lading/Air Waybill document number	A unique document number issued for traceability purposes.	Yes	Bill of lading/Air Waybill, Certificate of Analysis (COA)	
Certificate of Analysis number	A unique certificate number issued for traceability purposes.	Yes	Certificate of Analysis (COA)	
COA test lot identifier	This is a unique identifier allocated to all cartons, pallets and shipping containers for which an analysis sample represents.	Yes	Certificate of Analysis (COA)	
Company/product code	This is an in-house code for the identification of the product in the unit.	Yes	Bill of lading/Air Waybill, Certificate of Analysis (COA), Receipt of purchase/Tax Invoice	
Consignment Serial Shipping Container Code (SSCC)	Encoded in the GS1 barcode, this is a unique number which identifies the individual logistic unit i.e., shipment/message that is assigned by the establishment constructing the unit. The SSCC remains the same for the life of the logistic unit.	Yes	Bill of lading/Air Waybill, Meat Messaging Consignment Report, Meat Transfer Certificate (MTC)	For more information visit the GS1 website.
Count of Pallets	This is the number of pallets in the logistic unit e.g., container system unit.	Yes	Meat Messaging Consignment Report	
Count of Trade Items	Usually encoded in the GS1 barcode, this is the number of trade items e.g., cartons in the logistic unit.	Yes	Bill of lading/Air Waybill, Meat Messaging Consignment Report	For more information visit the GS1 website.
Date	This is the date of signing or of which a record entry or transaction was made.	Yes	Bill of lading/Air Waybill, Certificate of Analysis (COA), Meat Messaging Consignment Report,	

			Meat Transfer Certificate (MTC), Receipt of purchase/Tax Invoice	
Export Health Certificate Number	A unique number allocated to the health certificate issued for the export consignment for traceability purposes.	Yes	Export Health Certificate, Meat Messaging Consignment Report	For more information visit the Department of Agriculture, Water and the Environment website.
Export Permit Number	A unique permit number is allocated for the export consignment following submission of a correct and validated Request For Permit (RFP) which is then approved by the Secretary.	Yes	Export Permit	For more information visit the Department of Agriculture, Water and the Environment website.
From Establishment number	A number issued by Federal and State Authorities to identify the originating site from which meat or meat products were distributed to domestic or export markets. For transfer certificates, the Establishment numbers for both the dispatching and receiving establishments are recorded.	Yes	Certificate of Analysis (COA), Export Health Certificate, Meat Messaging Consignment Report, Meat Transfer Certificate (MTC)	
Global Trade Item Number (GTIN)	Encoded in the GS1 barcode, the GTIN is a globally unique 14-digit number used to identify trade items, products, or services.	Yes	Meat Messaging Consignment Report	For more information visit the GS1 website.
Movement date	The date on which livestock or other products (e.g., feed or meat products) were transported between PICs/establishments.	Yes	Bill of lading/Air Waybill, Certificate of Analysis (COA), Export Health Certificate, Meat Transfer Certificate (MTC)	
MSA Licence Number	Any establishment consigning, supplying, or identifying MSA Certified Product must be registered and have a unique MSA Licence Number.	Yes	Receipt of purchase/Tax Invoice	For more information on MSA visit the MLA website.
Net Weight (Kilograms)	Usually encoded in the GS1 barcode, the Net Weight is a variable measure of the trade item e.g., carton, pallet or shipment recorded in kilograms.	Yes	Bill of lading/Air Waybill, Export Health Certificate, Meat Messaging Consignment Report	For more information visit the GS1 website.
Packaging Date	Encoded in the GS1 barcode, the Packaging Date is the date on which the item was packaged and is recorded in the format year, month, day (YYMMDD).	Yes	Certificate of Analysis (COA)	For more information visit the GS1 website.
Pallet Serial Shipping Container Code (SSCC)	Encoded in the GS1 barcode, this is a unique number which identifies the individual logistic unit i.e., pallet that is assigned by the establishment constructing the unit. The SSCC remains the same for the life of the logistic unit.	Yes	Meat Messaging Consignment Report, Meat Transfer Certificate (MTC)	For more information visit the GS1 website.

Production Date (YYMMDD)	Encoded in the GS1 barcode, this is the 'kill' or slaughter' date of the product and is recorded in the format year, month, day (YYMMDD).	Yes	Certificate of Analysis (COA), Meat Transfer Certificate (MTC)	For more information visit the GS1 website.
Recipient Australian Business Number (ABN)	This is an 11-digit registration number, issued by the Australian Tax Office, used to identify businesses.	Yes	Receipt of purchase/Tax Invoice	For more information visit the ATO website.
Seal Serial Number	This is a unique serial number printed on any tamper-evident seal issued by the Department.	Yes	Bill of lading/Air Waybill, Meat Transfer Certificate (MTC), Official seal	For more information visit the GS1 website.
Seller/Supplier Australian Business Number (ABN)	This is an 11-digit registration number, issued by the Australian Tax Office, used to identify businesses.	Yes	Receipt of purchase/Tax Invoice	For more information visit the ATO website.
Shipping Mark	Also known as a port mark, this is a code comprising of three letters representing the foreign establishment number and the last nine digits of the consignment SSCC.	Yes	Bill of lading/Air Waybill, Certificate of Analysis (COA), Export Health Certificate, Meat Messaging Consignment Report	
To Establishment number	A number issued by Federal and State Authorities to identify the originating site from which meat or meat products were distributed to domestic or export markets. For transfer certificates, the Establishment numbers for both the dispatching and receiving establishments are recorded.	Yes	Meat Transfer Certificate (MTC)	
Trade description	This is a collective set of words that says what the product is and may include information such as species, net weight of product, name and address of establishments, category ciphers, market endorsements, MSA eating quality etc.	Yes	Export Health Certificate, Meat Messaging Consignment Report, Meat Transfer Certificate (MTC)	
Transfer Certificate number	A unique certificate number issued for traceability purposes.	Yes	Meat Messaging Consignment Report, Meat Transfer Certificate (MTC)	For more information visit the Department of Agriculture, Water and the Environment website.
Transport registration number	The registration number of the vehicle in which the animals or product were transported. For shipments of product this will be a shipping container number.	Yes	Bill of lading/Air Waybill, Export Health Certificate, Meat Messaging Consignment Report, Meat Transfer Certificate (MTC)	

5.2.5.2.3 Physical Outputs including Critical Tracking Events (CTEs)

NPEs are often buyers and resellers of meat and meat product, organising the documentation associated with the sale and exportation of product. They typically do not see the product; therefore, the outputs of the NPE system

are the Critical Tracking Event related documentation. These may include documents such as the Bill of lading/Air Waybill, Export Health Certificate and Certificate of Analysis.

Critical Tracking Events (CTEs) are defined as those events which include the growing, receiving, transforming, creating, and shipping of food products. Such events are critical to the traceability of product throughout the supply chain.

The CTEs associated with the outputs of the Non Packer Exporter system include the movement of:

- Information/ Documentation (meat and meat products Container System Unit)

off the property, premises or supply chain sector.

Table 111. Physical outputs and associated Critical Tracking Event related documents for a small stock non packer exporter system.

Event related to the inputs	Description of the inputs	Critical Tracking Event (CTE) related documents (including electronic)	More details
Information/ Documentation (meat and meat products Container System Unit)	As NPEs typically do not see the product, information/documentation includes the Critical Tracking Event related documentation and information required for product movement.	Bill of lading/Air Waybill, Delivery Docket/Manifest, Export Health Certificate, Export Permit, Meat Messaging Consignment Report, Meat Transfer Certificate (MTC), Official seal, Certificate of Analysis (COA), Receipt of purchase/Tax Invoice	

5.2.5.2.4 Information Outputs including Key Data Elements (KDEs)

Key Data Elements (KDEs) are defined as those elements which are key in identifying and tracing the Critical Tracking Event (CTE). Information outputs of the NPE system are those KDEs which can be drawn from CTE documentation. These may include document numbers for documents such as the Bill of lading/Air Waybill, Meat Transfer Certificate and Certificate of Analysis as well as other product specific information.

Table 112. Information outputs, Key Data Elements and Critical Tracking Event related documentation for a small stock non packer exporter system.

Attributes (including KDEs)	Description of the Attributes (including KDEs)	Is a KDE	Critical Tracking Event (CTE) related documents (including electronic)	More details
Analysis Date	This is the date on which a product sample was analysed.	Yes	Certificate of Analysis (COA)	
Bill of lading/Air Waybill document number	A unique document number issued for traceability purposes.	Yes	Bill of lading/Air Waybill, Certificate of Analysis (COA)	
Certificate of Analysis number	A unique certificate number issued for traceability purposes.	Yes	Certificate of Analysis (COA)	
COA test lot identifier	This is a unique identifier allocated to all cartons, pallets, and shipping containers for which an analysis sample represents.	Yes	Certificate of Analysis (COA)	

Company/product code	This is an in-house code for the identification of the product in the unit.	Yes	Bill of lading/Air Waybill, Certificate of Analysis (COA), Receipt of purchase/Tax Invoice	
Consignment Serial Shipping Container Code (SSCC)	Encoded in the GS1 barcode, this is a unique number which identifies the individual logistic unit i.e., shipment/message that is assigned by the establishment constructing the unit. The SSCC remains the same for the life of the logistic unit.	Yes	Bill of lading/Air Waybill, Meat Messaging Consignment Report, Meat Transfer Certificate (MTC)	For more information visit the GS1 website.
Count of Pallets	This is the number of pallets in the logistic unit e.g., container system unit.	Yes	Meat Messaging Consignment Report	
Count of Trade Items	Usually encoded in the GS1 barcode, this is the number of trade items e.g., cartons in the logistic unit.	Yes	Bill of lading/Air Waybill, Meat Messaging Consignment Report	For more information visit the GS1 website.
Date	This is the date of signing or of which a record entry or transaction was made.	Yes	Bill of lading/Air Waybill, Certificate of Analysis (COA), Meat Messaging Consignment Report, Meat Transfer Certificate (MTC), Receipt of purchase/Tax Invoice	
Export Health Certificate Number	A unique number allocated to the health certificate issued for the export consignment for traceability purposes.	Yes	Export Health Certificate, Meat Messaging Consignment Report	For more information visit the Department of Agriculture, Water and the Environment website.
Export Permit Number	A unique permit number is allocated for the export consignment following submission of a correct and validated Request For Permit (RFP) which is then approved by the Secretary.	Yes	Export Permit	For more information visit the Department of Agriculture, Water and the Environment website.
From Establishment number	A number issued by Federal and State Authorities to identify the originating site from which meat or meat products were distributed to domestic or export markets. For transfer certificates, the Establishment numbers for both the dispatching and receiving establishments are recorded.	Yes	Certificate of Analysis (COA), Export Health Certificate, Meat Messaging Consignment Report, Meat Transfer Certificate (MTC)	
Global Trade Item Number (GTIN)	Encoded in the GS1 barcode, the GTIN is a globally unique 14-digit number used to identify trade items, products, or services.	Yes	Meat Messaging Consignment Report	For more information visit the GS1 website.
Movement date	The date on which livestock or other products (e.g., feed or meat products) were transported between PICs/establishments.	Yes	Bill of lading/Air Waybill, Certificate of Analysis (COA), Export Health Certificate,	

			Meat Transfer Certificate (MTC)	
MSA Licence Number	Any establishment consigning, supplying or identifying MSA Certified Product must be registered and have a unique MSA Licence Number.	Yes	Receipt of purchase/Tax Invoice	For more information on MSA visit the MLA website.
Net Weight (Kilograms)	Usually encoded in the GS1 barcode, the Net Weight is a variable measure of the trade item e.g., carton, pallet or shipment recorded in kilograms.	Yes	Bill of lading/Air Waybill, Export Health Certificate, Meat Messaging Consignment Report	For more information visit the GS1 website.
Packaging Date	Encoded in the GS1 barcode, the Packaging Date is the date on which the item was packaged and is recorded in the format year, month, day (YYMMDD).	Yes	Certificate of Analysis (COA)	For more information visit the GS1 website.
Pallet Serial Shipping Container Code (SSCC)	Encoded in the GS1 barcode, this is a unique number which identifies the individual logistic unit i.e., pallet that is assigned by the establishment constructing the unit. The SSCC remains the same for the life of the logistic unit.	Yes	Meat Messaging Consignment Report, Meat Transfer Certificate (MTC)	For more information visit the GS1 website.
Production Date (YYMMDD)	Encoded in the GS1 barcode, this is the 'kill' or slaughter' date of the product and is recorded in the format year, month, day (YYMMDD).	Yes	Certificate of Analysis (COA), Meat Transfer Certificate (MTC)	For more information visit the GS1 website.
Recipient Australian Business Number (ABN)	This is an 11-digit registration number, issued by the Australian Tax Office, used to identify businesses.	Yes	Receipt of purchase/Tax Invoice	For more information visit the ATO website.
Seal Serial Number	This is a unique serial number printed on any tamper-evident seal issued by the Department.	Yes	Bill of lading/Air Waybill, Meat Transfer Certificate (MTC), Official seal	For more information visit the GS1 website.
Seller/Supplier Australian Business Number (ABN)	This is an 11-digit registration number, issued by the Australian Tax Office, used to identify businesses.	Yes	Receipt of purchase/Tax Invoice	For more information visit the ATO website.
Shipping Mark	Also known as a port mark, this is a code comprising of three letters representing the foreign establishment number and the last nine digits of the consignment SSCC.	Yes	Bill of lading/Air Waybill, Certificate of Analysis (COA), Export Health Certificate, Meat Messaging Consignment Report	
To Establishment number	A number issued by Federal and State Authorities to identify the originating site from which meat or meat products were distributed to domestic or export markets. For transfer certificates, the Establishment numbers for both the dispatching and receiving establishments are recorded.	Yes	Meat Transfer Certificate (MTC)	
Trade description	This is a collective set of words that says what the product is and may include information such as species, net weight of	Yes	Export Health Certificate, Meat Messaging	

	product, name and address of establishments, category ciphers, market endorsements, MSA eating quality etc.		Consignment Report, Meat Transfer Certificate (MTC)	
Transfer Certificate number	A unique certificate number issued for traceability purposes.	Yes	Meat Messaging Consignment Report, Meat Transfer Certificate (MTC)	For more information visit the Department of Agriculture, Water and the Environment website.
Transport registration number	The registration number of the vehicle in which the animals or product were transported. For shipments of product this will be a shipping container number.	Yes	Bill of lading/Air Waybill, Export Health Certificate, Meat Messaging Consignment Report, Meat Transfer Certificate (MTC)	

5.2.5.2.5 Regulatory and Industry Programs

- Meat Standards Australia (MSA)
- AUS-MEAT
- Department of Agriculture
- Export Documentation System (EXDOC)
- Meat Messaging
- Other data sources

5.2.5.2.6 Supply Chain Node Traceability

Non Packer Exporters (NPEs) are holders of a Meat Export Licence who do not operate a premises for the purpose of packaging meat for export registered under the Australian Government Department for Agriculture. Instead, NPEs are often buyers and resellers of product and organise the documentation associated with the sale and exportation of product.

Like exporters, the traceability of product which is traded by NPEs back to the live animal and property of origin is dependent on the form (carcase, carton) in which the product is being exported. All container system units undergoing export must be accompanied by a Meat Messaging Consignment Report and Meat Transfer Certificate (MTC) or Animal By Product Transfer Certificate (BPTC). While the NPE does not touch the product, they are involved in the preparation and handling of this documentation. The Consignment Report is issued to the buyer of product and lists all the logistic unit and subunit unique serialised identifiers contained within the Container System Unit including the Consignment Serial Shipping Container Code (SSCC), Pallet Serial Shipping Container Code, and scanned and verified carton label serial identifiers. Additionally, the Transfer Certificate details the serialised logistic unit identifiers such as the Serial Shipping Container Code (SSCC). These documents allow traceability of the unit and its subunits back to either the live animal and property of origin (for carcasses) or processor production run (for cartons and palletised meat and meat products).

For traceability information pertaining to carton and carcase products please refer to Boning Room and Carcase Chiller 'Supply Chain Node Traceability' respectively.

5.2.5.2.7 Data flow diagrams

Table 113. Data flow diagrams for the inputs and outputs of a small stock non-packer exporter system.

Direction	Description
Input	Cold Store (carcase) to Non-Packer Exporter
Input	Cold Store (carton) to Non-Packer Exporter
Input	Third Party Cold Store to Non-Packer Exporter
Output	Non-Packer Exporter to Import Inspection Facility

5.2.5.2.7.1 Cold Store (Carcase) to Non-Packer Exporter

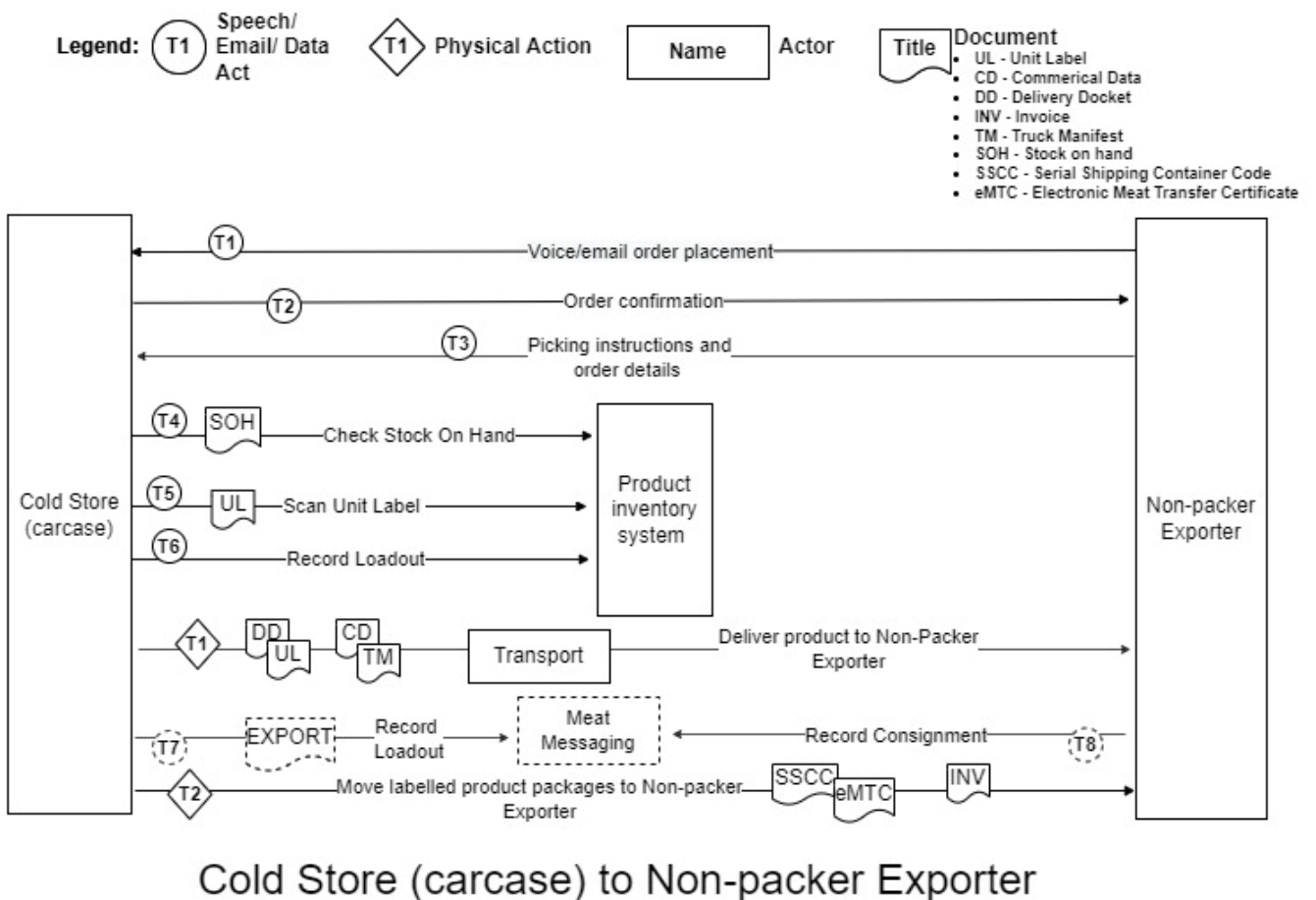
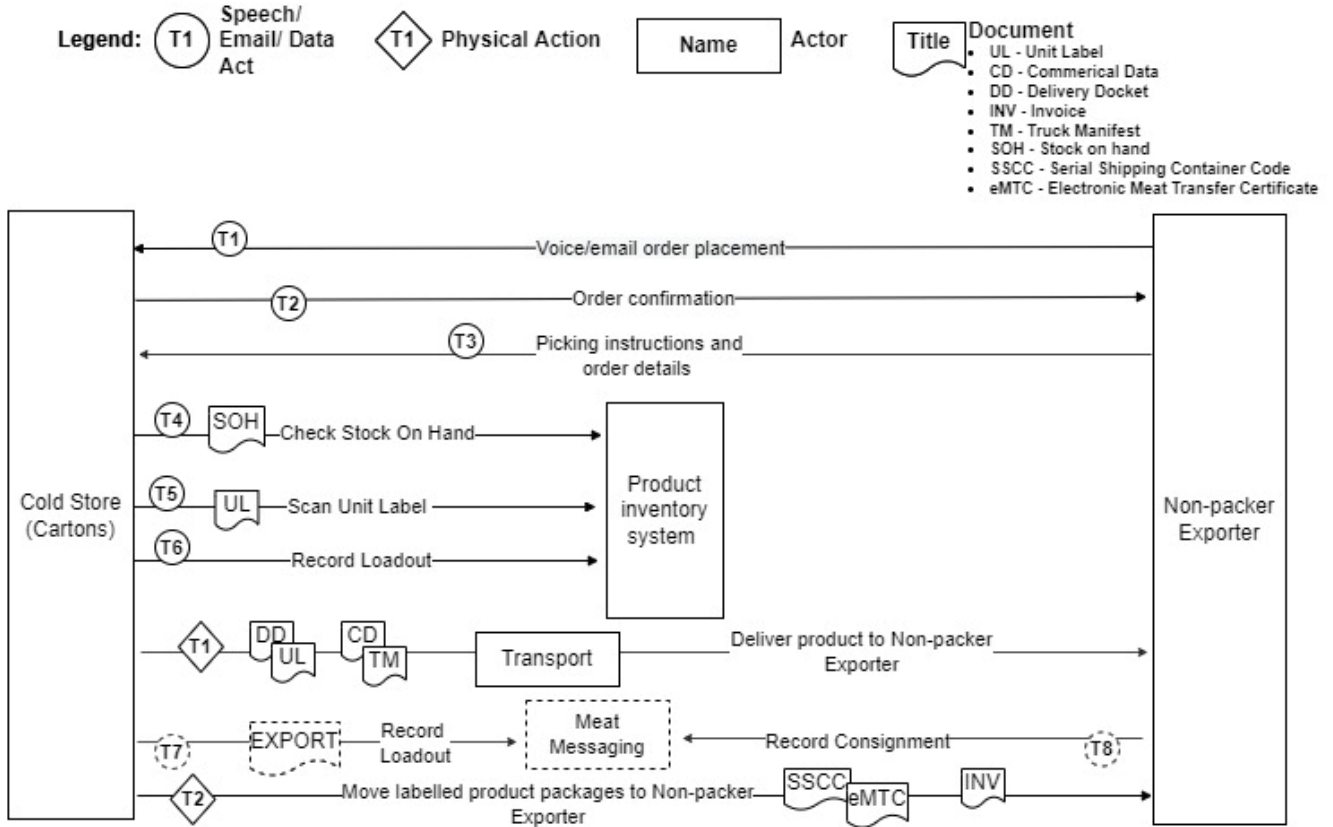

Figure 127. Data or information flows from the cold store (carcase) to non-packer exporter in the small stock supply chain.

5.2.5.2.7.2 Cold Store (Carton) to Non-Packer Exporter



Cold Store (Cartons) to Non-packer Exporter

Figure 128. Data or information flows from the cold store (cartons) to non-packer exporter in the small stock supply chain.

5.2.5.2.7.3 Third Party Cold Store to Non-Packer Exporter

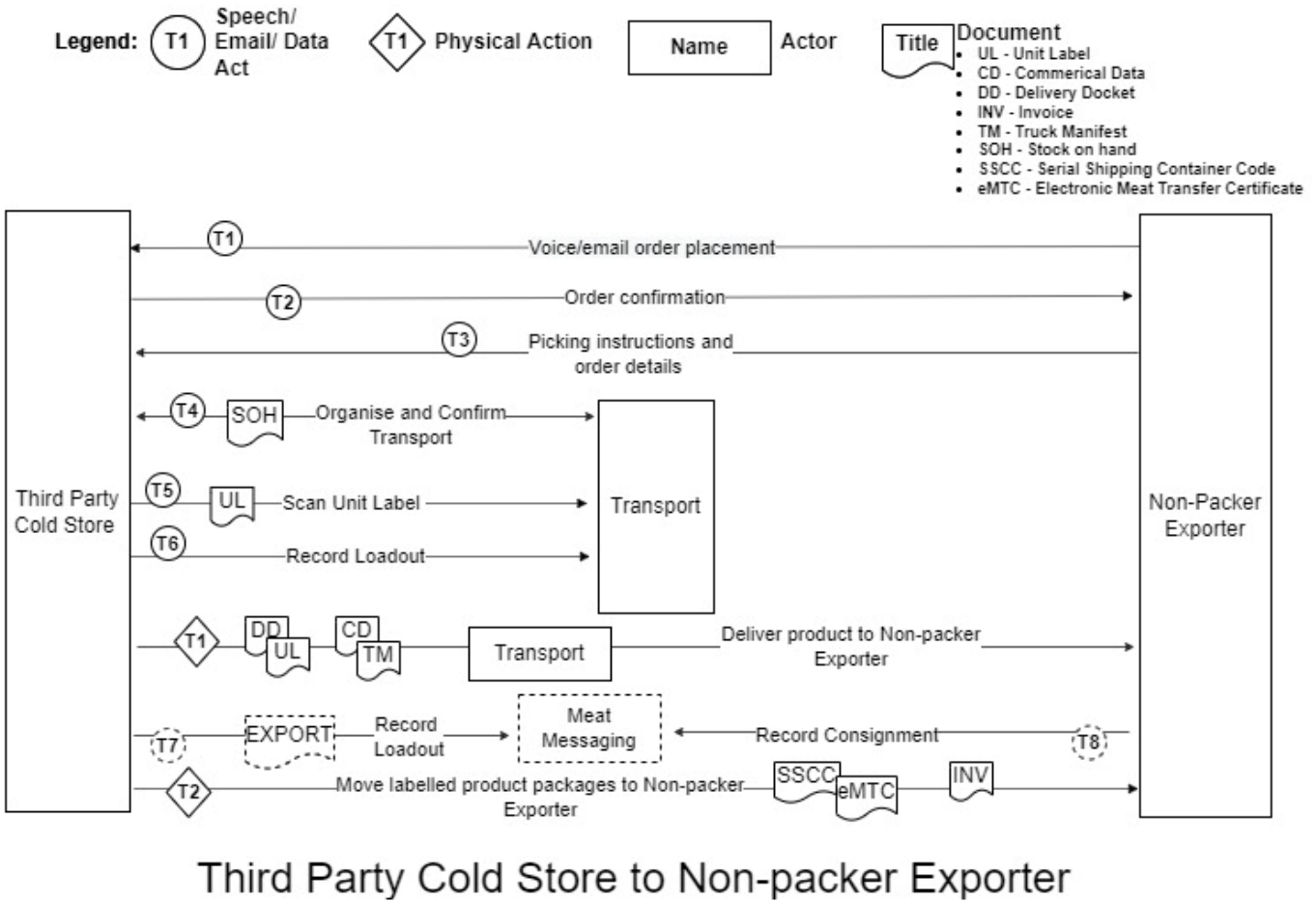
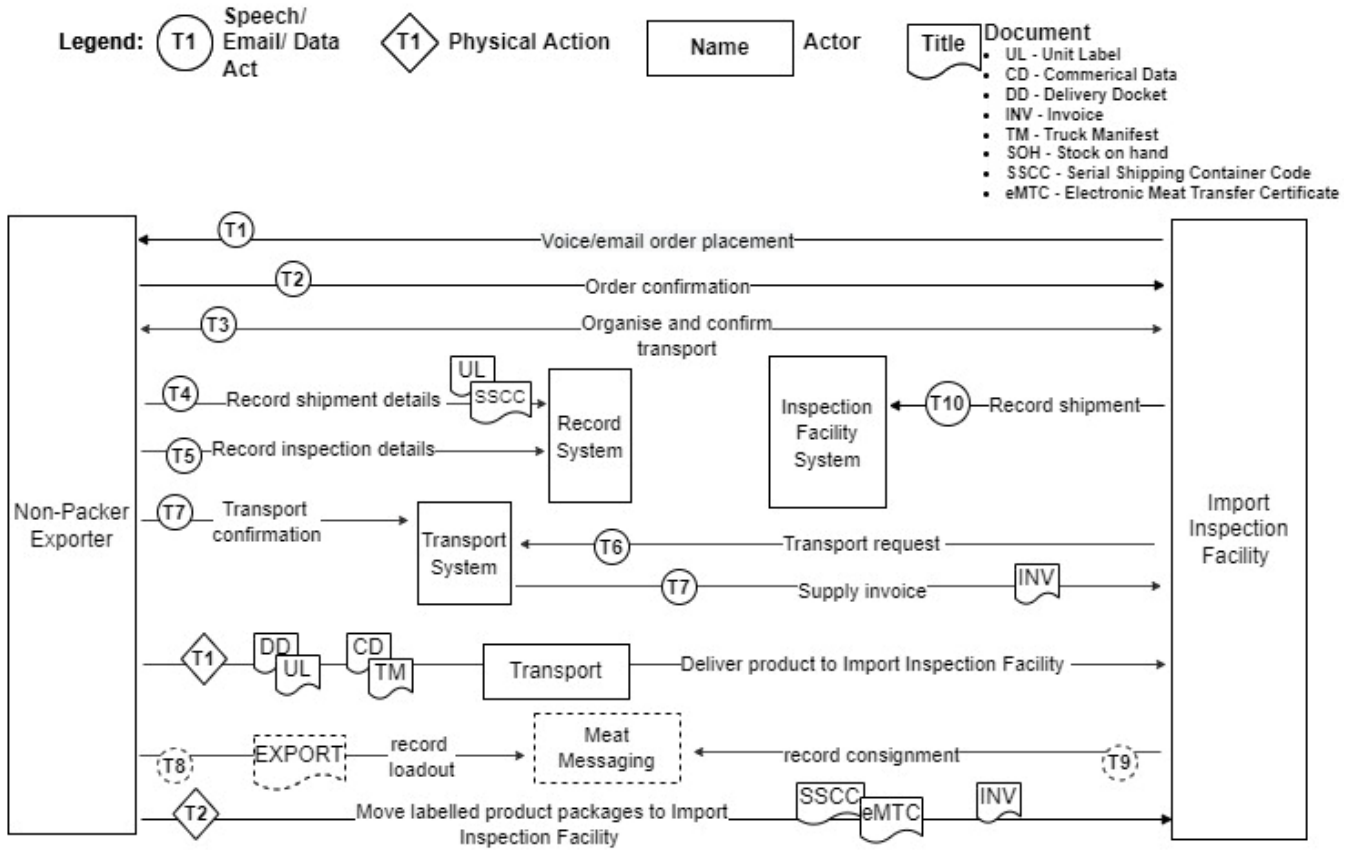

Figure 129. Data or information flows from the third-party cold store to non-packer exporter in the small stock supply chain.

5.2.5.2.7.4 Non-Packer Exporter to Import Inspection Facility



Non-Packer Exporter to Import Inspection Facility

Figure 130. Data or information flows from the non-packer exporter to import inspection facility in the small stock supply chain.

5.2.5.3 Export

Australia is one of the largest exporters of sheep meat in the world by volume and value of meat and this is largely due to strict animal welfare practices and quality control standards. This has allowed consumer demand for Australian mutton and lamb to remain strong in a competitive global market against other large exporters such as New Zealand. Australia principally exports meat to China, the US, and the Middle East. Simply, the export process involves the licensing of export premises, inspection of meat and meat products, process auditing, loading, and movement of product. Meat and meat products or meat by-products (packaged into container system units) are typically delivered to the port of export, via refrigerated or bulk transport respectively, for loading into the export vessel.

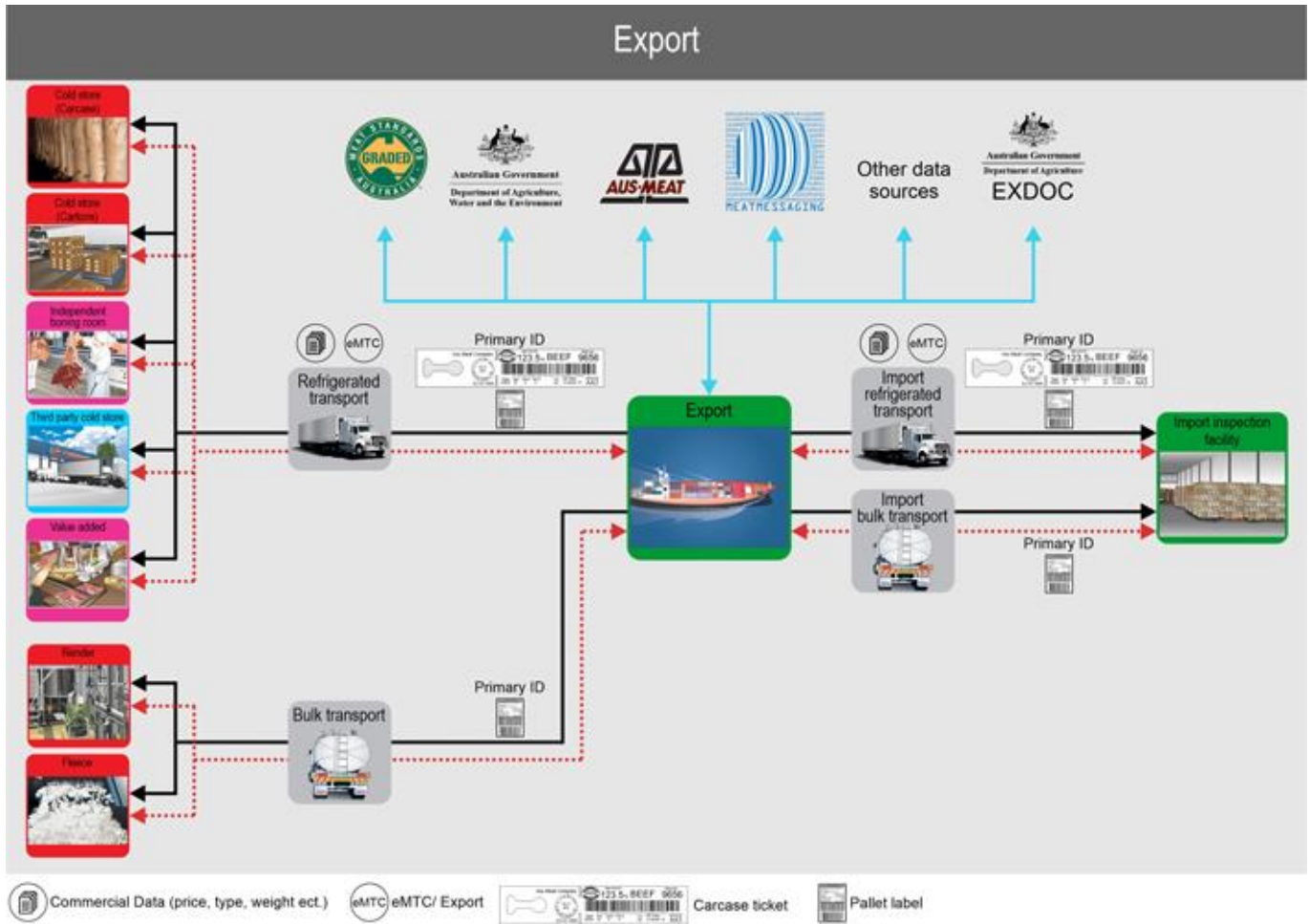

Figure 131. Inputs and outputs of the small stock supply chain export sector.

5.2.5.3.1 Physical Inputs including Critical Tracking Events (CTEs)

Prior to export, packaged product is loaded into refrigerated shipping containers and transported to the export port to be loaded into ships or airfreight. Therefore, container system units, which contain packaged meat product, are the physical inputs to the export system. Critical Tracking Event related documentation such as the Bill of lading/Air Waybill, as well as Export Health Certificate and Certificate of Analysis, must accompany the movement of product to an importing country.

Critical Tracking Events (CTEs) are defined as those events which include the growing, receiving, transforming, creating, and shipping of food products. Such events are critical to the traceability of product throughout the supply chain.

The CTEs associated with inputs to the export system include the receipt of:

- Container System Unit (meat and meat products)
- Container System Unit (render and hide product).

Table 114. Physical inputs and associated Critical Tracking Event related documents for a small stock export system.

Event related to the inputs	Description of the inputs	Critical Tracking Event (CTE) related documents (including electronic)	More details
Container System Unit (meat and meat products)	A container designed for use as a unit of cargo handling equipment in the transport of goods by aircraft or ship.	Bill of lading/Air Waybill, Certificate of Analysis (COA), Delivery Docket/Manifest, Export Health Certificate, Export Permit, Meat Messaging Consignment Report, Meat Transfer Certificate (MTC), Official seal, Receipt of purchase/Tax Invoice	
Container System Unit (render and hide product)	A container designed for use as a unit of cargo handling equipment in the transport of goods by aircraft or ship.	Animal By Product Transfer Certificate (BPTC), Bill of lading/Air Waybill, Certificate of Analysis (COA), Delivery Docket/Manifest, Export clearance documentation, Export Permit, Meat Messaging Consignment Report, Receipt of purchase/Tax Invoice	

5.2.5.3.2 Information Inputs including Key Data Elements (KDEs)

Key Data Elements (KDEs) are defined as those elements which are key in identifying and tracing the Critical Tracking Event (CTE). Information inputs into the export system are those KDEs which can be drawn from CTE documentation. These may include document numbers for documents such as the Bill of lading/Air Waybill, Meat Transfer Certificate and Certificate of Analysis as well as other product specific information.

Table 115. Information inputs, Key Data Elements and Critical Tracking Event related documentation for a small stock export system.

Attributes (including KDEs)	Description of the Attributes (including KDEs)	Is a KDE	Critical Tracking Event (CTE) related documents (including electronic)	More details
Analysis Date	This is the date on which a product sample was analysed.	Yes	Certificate of Analysis (COA)	
Bill of lading/Air Waybill document number	A unique document number issued for traceability purposes.	Yes	Bill of lading/Air Waybill, Certificate of Analysis (COA)	
Certificate of Analysis number	A unique certificate number issued for traceability purposes.	Yes	Certificate of Analysis (COA)	
COA test lot identifier	This is a unique identifier allocated to all cartons, pallets, and shipping containers for which an analysis sample represents.	Yes	Certificate of Analysis (COA)	
Company/product code	This is an in-house code for the identification of the product in the unit.	Yes	Bill of lading/Air Waybill, Certificate of Analysis (COA), Receipt of purchase/Tax Invoice	
Consignment Serial Shipping Container Code (SSCC)	Encoded in the GS1 barcode, this is a unique number which identifies the individual logistic unit i.e., shipment/message that is assigned by the establishment constructing	Yes	Animal By Product Transfer Certificate (BPTC), Bill of lading/Air Waybill, Export clearance documentation, Meat Messaging Consignment	For more information visit the GS1 website.

	the unit. The SSCC remains the same for the life of the logistic unit.		Report, Meat Transfer Certificate (MTC)	
Contract number	This is a unique number allocated to the contract by the seller.	Yes	Delivery Docket/Manifest	
Count of Pallets	This is the number of pallets in the logistic unit e.g., container system unit.	Yes	Meat Messaging Consignment Report	
Count of Trade Items	Usually encoded in the GS1 barcode, this is the number of trade items e.g., cartons in the logistic unit.	Yes	Bill of lading/Air Waybill, Delivery Docket/Manifest, Meat Messaging Consignment Report	For more information visit the GS1 website.
Date	This is the date of signing or of which a record entry or transaction was made.	Yes	Animal By Product Transfer Certificate (BPTC), Bill of lading/Air Waybill, Certificate of Analysis (COA), Delivery Docket/Manifest, Export clearance documentation, Meat Messaging Consignment Report, Meat Transfer Certificate (MTC), Receipt of purchase/Tax Invoice	
Delivery Docket/Manifest number	This is a unique number allocated to the docket for identification purposes.	Yes	Delivery Docket/Manifest	
Export Health Certificate Number	A unique number allocated to the health certificate issued for the export consignment for traceability purposes.	Yes	Export Health Certificate, Meat Messaging Consignment Report	For more information visit the Department of Agriculture, Water and the Environment website.
Export Permit Number	A unique permit number is allocated for the export consignment following submission of a correct and validated Request For Permit (RFP) which is then approved by the Secretary.	Yes	Export Permit	For more information visit the Department of Agriculture, Water and the Environment website.
From Establishment number	A number issued by Federal and State Authorities to identify the originating site from which meat or meat products were distributed to domestic or export markets. For transfer certificates, the Establishment numbers for both the dispatching and receiving establishments are recorded.	Yes	Animal By Product Transfer Certificate (BPTC), Certificate of Analysis (COA), Delivery Docket/Manifest, Export clearance documentation, Export Health Certificate, Meat Messaging Consignment Report, Meat Transfer Certificate (MTC)	
Global Trade Item Number (GTIN)	Encoded in the GS1 barcode, the GTIN is a globally unique 14-digit number used to identify trade items, products, or services.	Yes	Meat Messaging Consignment Report	

Movement date	The date on which livestock or other products (e.g., feed or meat products) were transported between PICs/establishments.	Yes	Animal By Product Transfer Certificate (BPTC), Bill of lading/Air Waybill, Certificate of Analysis (COA), Delivery Docket/Manifest, Export clearance documentation, Export Health Certificate, Meat Transfer Certificate (MTC)	
MSA Licence Number	Any establishment consigning, supplying or identifying MSA Certified Product must be registered and have a unique MSA Licence Number.	Yes	Receipt of purchase/Tax Invoice	For more information on MSA visit the MLA website.
Net Weight (Kilograms)	Usually encoded in the GS1 barcode, the Net Weight is a variable measure of the trade item e.g., carton, pallet or shipment recorded in kilograms.	Yes	Bill of lading/Air Waybill, Export Health Certificate, Meat Messaging Consignment Report	For more information visit the GS1 website.
Order date	This is the date on which the purchase order or contract was raised by the buyer.	Yes	Delivery Docket/Manifest	
Packaging Date	Encoded in the GS1 barcode, the Packaging Date is the date on which the item was packaged and is recorded in the format year, month, day (YYMMDD).	Yes	Certificate of Analysis (COA)	For more information visit the GS1 website.
Packaging Date Range	This includes the oldest and newest packaging dates for the logistic unit.	Yes	Export clearance documentation	For more information visit the GS1 website.
Pallet Serial Shipping Container Code (SSCC)	Encoded in the GS1 barcode, this is a unique number which identifies the individual logistic unit i.e., pallet that is assigned by the establishment constructing the unit. The SSCC remains the same for the life of the logistic unit.	Yes	Animal By Product Transfer Certificate (BPTC), Export clearance documentation, Meat Messaging Consignment Report, Meat Transfer Certificate (MTC)	For more information visit the GS1 website.
Production Date (YYMMDD)	Encoded in the GS1 barcode, this is the 'kill' or slaughter' date of the product and is recorded in the format year, month, day (YYMMDD).	Yes	Animal By Product Transfer Certificate (BPTC), Certificate of Analysis (COA), Meat Transfer Certificate (MTC)	For more information visit the GS1 website.
Recipient Australian Business Number (ABN)	This is an 11-digit registration number, issued by the Australian Tax Office, used to identify businesses.	Yes	Receipt of purchase/Tax Invoice	For more information visit the ATO website.
Seal Serial Number	This is a unique serial number printed on any tamper-evident seal issued by the Department.	Yes	Animal By Product Transfer Certificate (BPTC), Bill of lading/Air Waybill, Export clearance documentation, Meat Transfer Certificate (MTC), Official seal	For more information visit the Australian Government Federal Register of Legislation.
Seller/Supplier Australian	This is an 11-digit registration number, issued by the Australian	Yes	Receipt of purchase/Tax Invoice	For more information

Business Number (ABN)	Tax Office, used to identify businesses.			visit the ATO website.
Shipping Mark	Also known as a port mark, this is a code comprising of three letters representing the foreign establishment number and the last nine digits of the consignment SSCC.	Yes	Bill of lading/Air Waybill, Certificate of Analysis (COA), Delivery Docket/Manifest, Export Health Certificate, Meat Messaging Consignment Report	
To Establishment number	A number issued by Federal and State Authorities to identify the originating site from which meat or meat products were distributed to domestic or export markets. For transfer certificates, the Establishment numbers for both the dispatching and receiving establishments are recorded.	Yes	Animal By Product Transfer Certificate (BPTC), Export clearance documentation, Meat Transfer Certificate (MTC)	
Trade description	This is a collective set of words that says what the product is and may include information such as species, net weight of product, name and address of establishments, category ciphers, market endorsements, MSA eating quality etc.	Yes	Animal By Product Transfer Certificate (BPTC), Delivery Docket/Manifest, Export clearance documentation, Export Health Certificate Meat Messaging Consignment Report, Meat Transfer Certificate (MTC)	
Transfer Certificate number	A unique certificate number issued for traceability purposes.	Yes	Animal By Product Transfer Certificate (BPTC), Meat Messaging Consignment Report, Meat Transfer Certificate (MTC)	
Transport registration number	The registration number of the vehicle in which the animals or product were transported. For shipments of product this will be a shipping container number.	Yes	Animal By Product Transfer Certificate (BPTC), Bill of lading/Air Waybill, Delivery Docket/Manifest, Export clearance documentation, Export Health Certificate, Meat Messaging Consignment Report, Meat Transfer Certificate (MTC)	

5.2.5.3.3 Physical Outputs including Critical Tracking Events (CTEs)

Container system units, which contain packaged meat product, are the physical outputs of the export system. Critical Tracking Event related documentation such as the Bill of lading/Air Waybill, as well as Export Health Certificate and Certificate of Analysis, must accompany the movement of product to an importing country.

Critical Tracking Events (CTEs) are defined as those events which include the growing, receiving, transforming, creating, and shipping of food products. Such events are critical to the traceability of product throughout the supply chain.

The CTEs associated with the outputs of the export system include the movement of:

- Container System Unit (meat and meat products)

- Container System Unit (render and hide product)

off the property, premises, or supply chain sector.

Table 116. Physical outputs and associated Critical Tracking Event related documents for a small stock export system.

Event related to the inputs	Description of the inputs	Critical Tracking Event (CTE) related documents (including electronic)	More details
Container System Unit (meat and meat products)	A container designed for use as a unit of cargo handling equipment in the transport of goods by aircraft or ship.	Bill of lading/Air Waybill, Certificate of Analysis (COA), Delivery Docket/Manifest, Export Health Certificate, Export Permit, Meat Messaging Consignment Report, Meat Transfer Certificate (MTC), Official seal, Receipt of purchase/Tax Invoice	
Container System Unit (render and hide product)	A container designed for use as a unit of cargo handling equipment in the transport of goods by aircraft or ship.	Animal By Product Transfer Certificate (BPTC), Bill of lading/Air Waybill, Certificate of Analysis (COA), Delivery Docket/Manifest, Export clearance documentation, Export Permit, Meat Messaging Consignment Report, Receipt of purchase/Tax Invoice	

5.2.5.3.4 Information Outputs including Key Data Elements (KDEs)

Key Data Elements (KDEs) are defined as those elements which are key in identifying and tracing the Critical Tracking Event (CTE). Information outputs from the export system are those KDEs which can be drawn from CTE documentation. These may include document numbers for documents such as the Bill of lading/Air Waybill, Meat Transfer Certificate and Certificate of Analysis as well as other product specific information.

Table 117. Information outputs, Key Data Elements and Critical Tracking Event related documentation for a small stock export system.

Attributes (including KDEs)	Description of the Attributes (including KDEs)	Is a KDE	Critical Tracking Event (CTE) related documents (including electronic)	More details
Analysis Date	This is the date on which a product sample was analysed.	Yes	Certificate of Analysis (COA)	
Bill of lading/Air Waybill document number	A unique document number issued for traceability purposes.	Yes	Bill of lading/Air Waybill, Certificate of Analysis (COA)	
Certificate of Analysis number	A unique certificate number issued for traceability purposes.	Yes	Certificate of Analysis (COA)	
COA test lot identifier	This is a unique identifier allocated to all cartons, pallets, and shipping containers for which an analysis sample represents.	Yes	Certificate of Analysis (COA)	
Company/product code	This is an in-house code for the identification of the product in the unit.	Yes	Bill of lading/Air Waybill, Certificate of Analysis (COA), Receipt of purchase/Tax Invoice	
Consignment Serial Shipping Container Code (SSCC)	Encoded in the GS1 barcode, this is a unique number which identifies the individual logistic unit i.e., shipment/message that is assigned by the establishment constructing	Yes	Animal By Product Transfer Certificate (BPTC), Bill of lading/Air Waybill, Export clearance documentation, Meat Messaging Consignment	For more information visit the GS1 website.

	the unit. The SSCC remains the same for the life of the logistic unit.		Report, Meat Transfer Certificate (MTC)	
Contract number	This is a unique number allocated to the contract by the seller.	Yes	Delivery Docket/Manifest	
Count of Pallets	This is the number of pallets in the logistic unit e.g., container system unit.	Yes	Meat Messaging Consignment Report	
Count of Trade Items	Usually encoded in the GS1 barcode, this is the number of trade items e.g., cartons in the logistic unit.	Yes	Bill of lading/Air Waybill, Delivery Docket/Manifest, Meat Messaging Consignment Report	For more information visit the GS1 website.
Date	This is the date of signing or of which a record entry or transaction was made.	Yes	Animal By Product Transfer Certificate (BPTC), Bill of lading/Air Waybill, Certificate of Analysis (COA), Delivery Docket/Manifest, Export clearance documentation, Meat Messaging Consignment Report, Meat Transfer Certificate (MTC), Receipt of purchase/Tax Invoice	
Delivery Docket/Manifest number	This is a unique number allocated to the docket for identification purposes.	Yes	Delivery Docket/Manifest	
Export Health Certificate Number	A unique number allocated to the health certificate issued for the export consignment for traceability purposes.	Yes	Export Health Certificate, Meat Messaging Consignment Report	For more information visit the Department of Agriculture, Water and the Environment website.
Export Permit Number	A unique permit number is allocated for the export consignment following submission of a correct and validated Request For Permit (RFP) which is then approved by the Secretary.	Yes	Export Permit	For more information visit the Department of Agriculture, Water and the Environment website.
From Establishment number	A number issued by Federal and State Authorities to identify the originating site from which meat or meat products were distributed to domestic or export markets. For transfer certificates, the Establishment numbers for both the dispatching and receiving establishments are recorded.	Yes	Animal By Product Transfer Certificate (BPTC), Certificate of Analysis (COA), Delivery Docket/Manifest, Export clearance documentation, Export Health Certificate, Meat Messaging Consignment Report, Meat Transfer Certificate (MTC)	
Global Trade Item Number (GTIN)	Encoded in the GS1 barcode, the GTIN is a globally unique 14-digit number used to identify trade items, products, or services.	Yes	Meat Messaging Consignment Report	For more information visit the GS1 website.

Movement date	The date on which livestock or other products (e.g., feed or meat products) were transported between PICs/establishments.	Yes	Animal By Product Transfer Certificate (BPTC), Bill of lading/Air Waybill, Certificate of Analysis (COA), Delivery Docket/Manifest, Export clearance documentation, Export Health Certificate, Meat Transfer Certificate (MTC)	
MSA Licence Number	Any establishment consigning, supplying, or identifying MSA Certified Product must be registered and have a unique MSA Licence Number.	Yes	Receipt of purchase/Tax Invoice	For more information on MSA visit the MLA website.
Net Weight (Kilograms)	Usually encoded in the GS1 barcode, the Net Weight is a variable measure of the trade item e.g., carton, pallet or shipment recorded in kilograms.	Yes	Bill of lading/Air Waybill, Export Health Certificate, Meat Messaging Consignment Report	For more information visit the GS1 website.
Order date	This is the date on which the purchase order or contract was raised by the buyer.	Yes	Delivery Docket/Manifest	
Packaging Date	Encoded in the GS1 barcode, the Packaging Date is the date on which the item was packaged and is recorded in the format year, month, day (YYMMDD).	Yes	Certificate of Analysis (COA)	For more information visit the GS1 website.
Packaging Date Range	This includes the oldest and newest packaging dates for the logistic unit.	Yes	Export clearance documentation	For more information visit the GS1 website.
Pallet Serial Shipping Container Code (SSCC)	Encoded in the GS1 barcode, this is a unique number which identifies the individual logistic unit i.e., pallet that is assigned by the establishment constructing the unit. The SSCC remains the same for the life of the logistic unit.	Yes	Animal By Product Transfer Certificate (BPTC), Export clearance documentation, Meat Messaging Consignment Report, Meat Transfer Certificate (MTC)	For more information visit the GS1 website.
Production Date (YYMMDD)	Encoded in the GS1 barcode, this is the 'kill' or slaughter' date of the product and is recorded in the format year, month, day (YYMMDD).	Yes	Animal By Product Transfer Certificate (BPTC), Certificate of Analysis (COA), Meat Transfer Certificate (MTC)	For more information visit the GS1 website.
Recipient Australian Business Number (ABN)	This is an 11-digit registration number, issued by the Australian Tax Office, used to identify businesses.	Yes	Receipt of purchase/Tax Invoice	For more information visit the ATO website.
Seal Serial Number	This is a unique serial number printed on any tamper-evident seal issued by the Department.	Yes	Animal By Product Transfer Certificate (BPTC), Bill of lading/Air Waybill, Export clearance documentation, Meat Transfer Certificate (MTC), Official seal	For more information visit the Australian Government Federal Register of Legislation.
Seller/Supplier Australian	This is an 11-digit registration number, issued by the Australian	Yes	Receipt of purchase/Tax Invoice	For more information

Business Number (ABN)	Tax Office, used to identify businesses.			visit the ATO website.
Shipping Mark	Also known as a port mark, this is a code comprising of three letters representing the foreign establishment number and the last nine digits of the consignment SSCC.	Yes	Bill of lading/Air Waybill, Certificate of Analysis (COA), Delivery Docket/Manifest, Export Health Certificate, Meat Messaging Consignment Report	
To Establishment number	A number issued by Federal and State Authorities to identify the originating site from which meat or meat products were distributed to domestic or export markets. For transfer certificates, the Establishment numbers for both the dispatching and receiving establishments are recorded.	Yes	Animal By Product Transfer Certificate (BPTC), Export clearance documentation, Meat Transfer Certificate (MTC)	
Trade description	This is a collective set of words that says what the product is and may include information such as species, net weight of product, name and address of establishments, category ciphers, market endorsements, MSA eating quality etc.	Yes	Animal By Product Transfer Certificate (BPTC), Delivery Docket/Manifest, Export clearance documentation, Export Health Certificate, Meat Messaging Consignment Report, Meat Transfer Certificate (MTC)	
Transfer Certificate number	A unique certificate number issued for traceability purposes.	Yes	Animal By Product Transfer Certificate (BPTC), Meat Messaging Consignment Report, Meat Transfer Certificate (MTC)	
Transport registration number	The registration number of the vehicle in which the animals or product were transported. For shipments of product this will be a shipping container number.	Yes	Animal By Product Transfer Certificate (BPTC), Bill of lading/Air Waybill, Delivery Docket/Manifest, Export clearance documentation, Export Health Certificate, Meat Messaging Consignment Report, Meat Transfer Certificate (MTC)	

5.2.5.3.5 Regulatory and Industry Programs

- Meat Standards Australia (MSA)
- AUS-MEAT
- Department of Agriculture
- Export Documentation System (EXDOC)
- Meat Messaging
- Other data sources

5.2.5.3.6 Supply Chain Node Traceability

The traceability of product undergoing export/importation back to the live animal, or consignment group and property of origin is dependent on the form (carcase, carton, pallet or render store bag subunits) in which the

product is being exported/imported. All container system units undergoing export must be accompanied by a Meat Messaging Consignment Report and a Meat Transfer Certificate (MTC) or Animal By Product Transfer Certificate (BPTC). The Consignment Report is issued to the buyer of product and lists all the logistic unit and subunit unique serialised identifiers contained within the Container System Unit including the Consignment Serial Shipping Container Code (SSCC), Pallet Serial Shipping Container Code, and scanned and verified carton label serial identifiers. Additionally, the Transfer Certificate details the serialised logistic unit identifiers such as the Serial Shipping Container Code (SSCC). These documents allow traceability of the unit and its subunits back to either the live animal and property of origin (for carcasses) or processor production run (for cartons and palletised meat and meat products).

For traceability information pertaining to render and hide products please refer to 'Supply Chain Node Traceability' under each of these nodes. For carton and carcass products please refer to Boning Room and Carcass Chiller 'Supply Chain Node Traceability' respectively.

5.2.5.3.7 Data flow diagrams

Table 118. Data flow diagrams for the inputs and outputs of a small stock export system.

Direction	Description
Input	Cold Store (Carcass) to Export
Input	Cold Store (Carton) to Export
Input	Third Party Cold Store to Export
Input	Value Added to Export
Input	Render to Export
Input	Hides to Export
Output	Export to Import Inspection Facility

5.2.5.3.7.1 Cold Store (Carcase) to Export

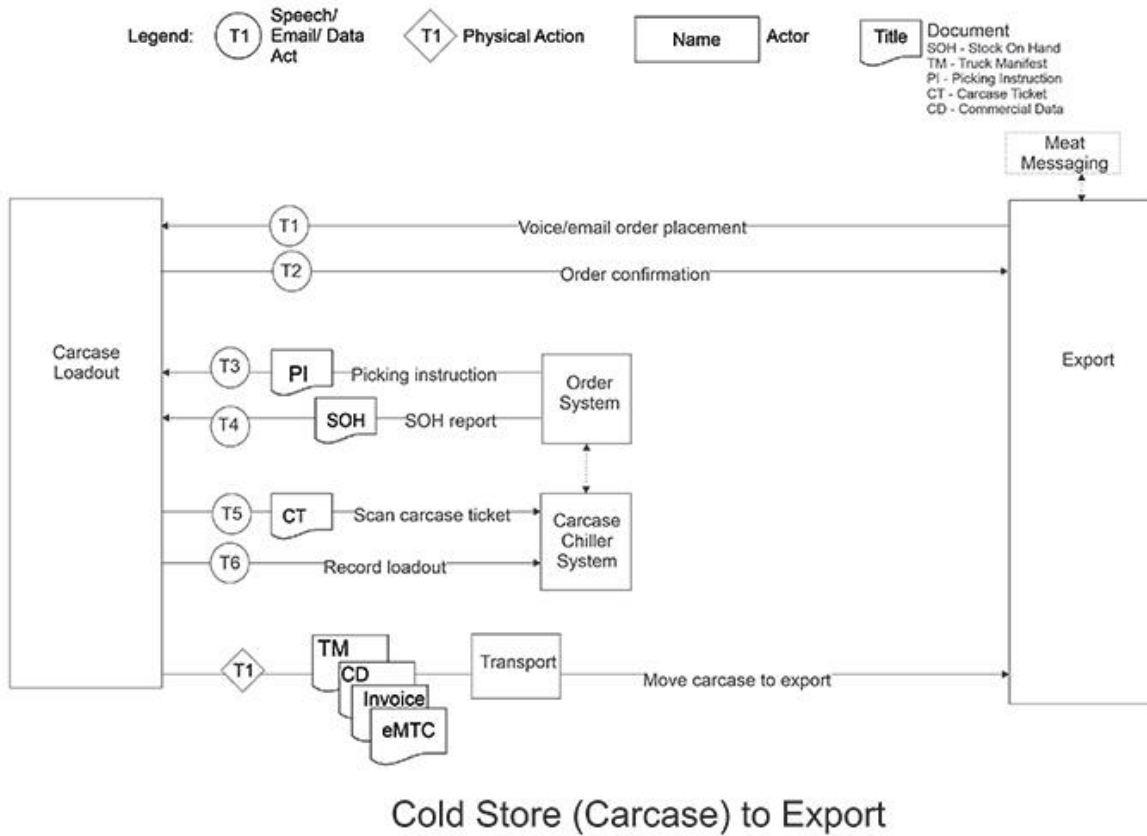

Figure 132. Data or information flows from the cold store (carcass) to export systems in the small stock supply chain.

5.2.5.3.7.2 Cold Store (Carton) to Export

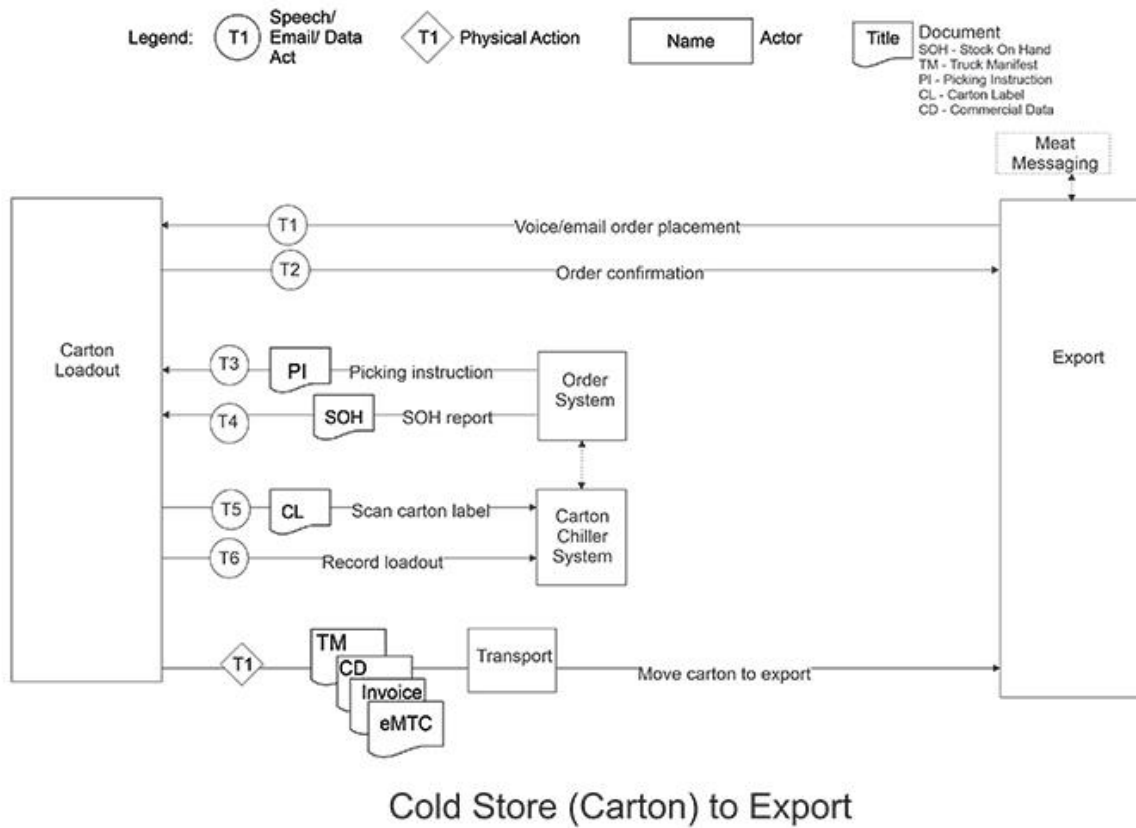
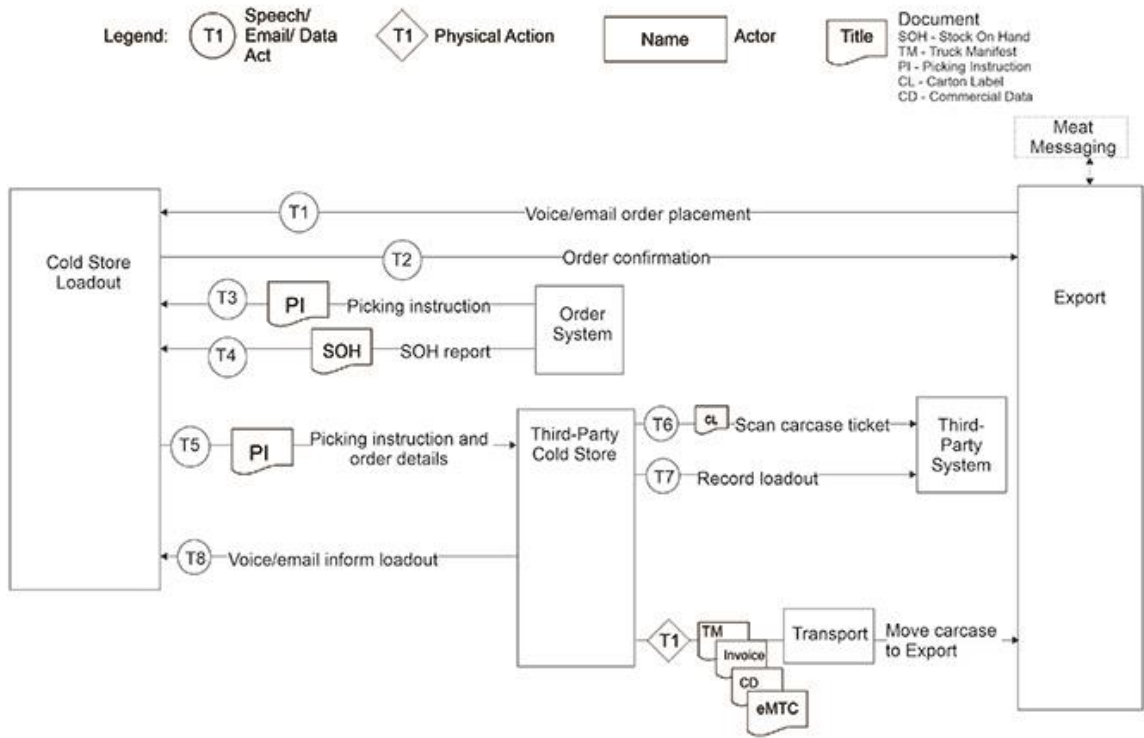

Figure 133. Data or information flows from the cold store (carton) to export systems in the small stock supply chain.

5.2.5.3.7.3 Third Party Cold Store to Export



Third-Party Cold Store to Export

Figure 134. Data or information flows from the third-party cold store to export systems in the small stock supply chain.

5.2.5.3.7.4 Value Added to Export

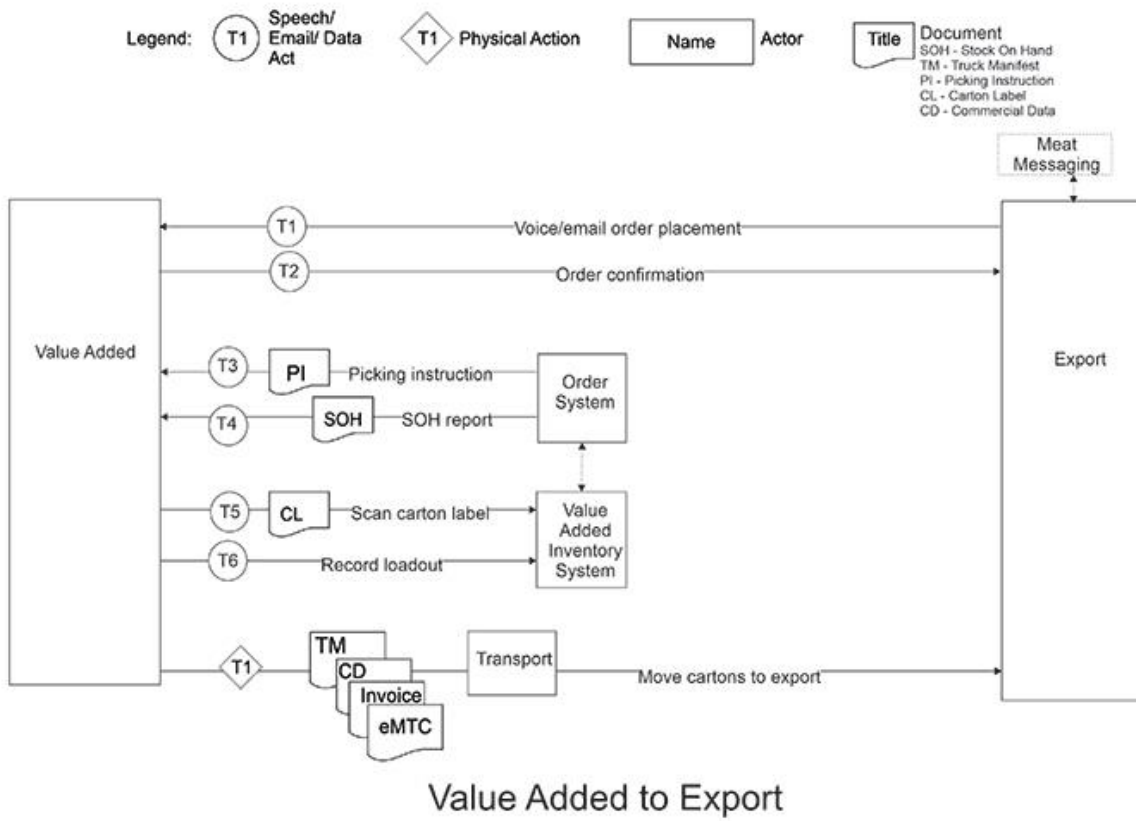

Figure 135. Data or information flows from the value added to export systems in the small stock supply chain.

5.2.5.3.7.5 Render to Export

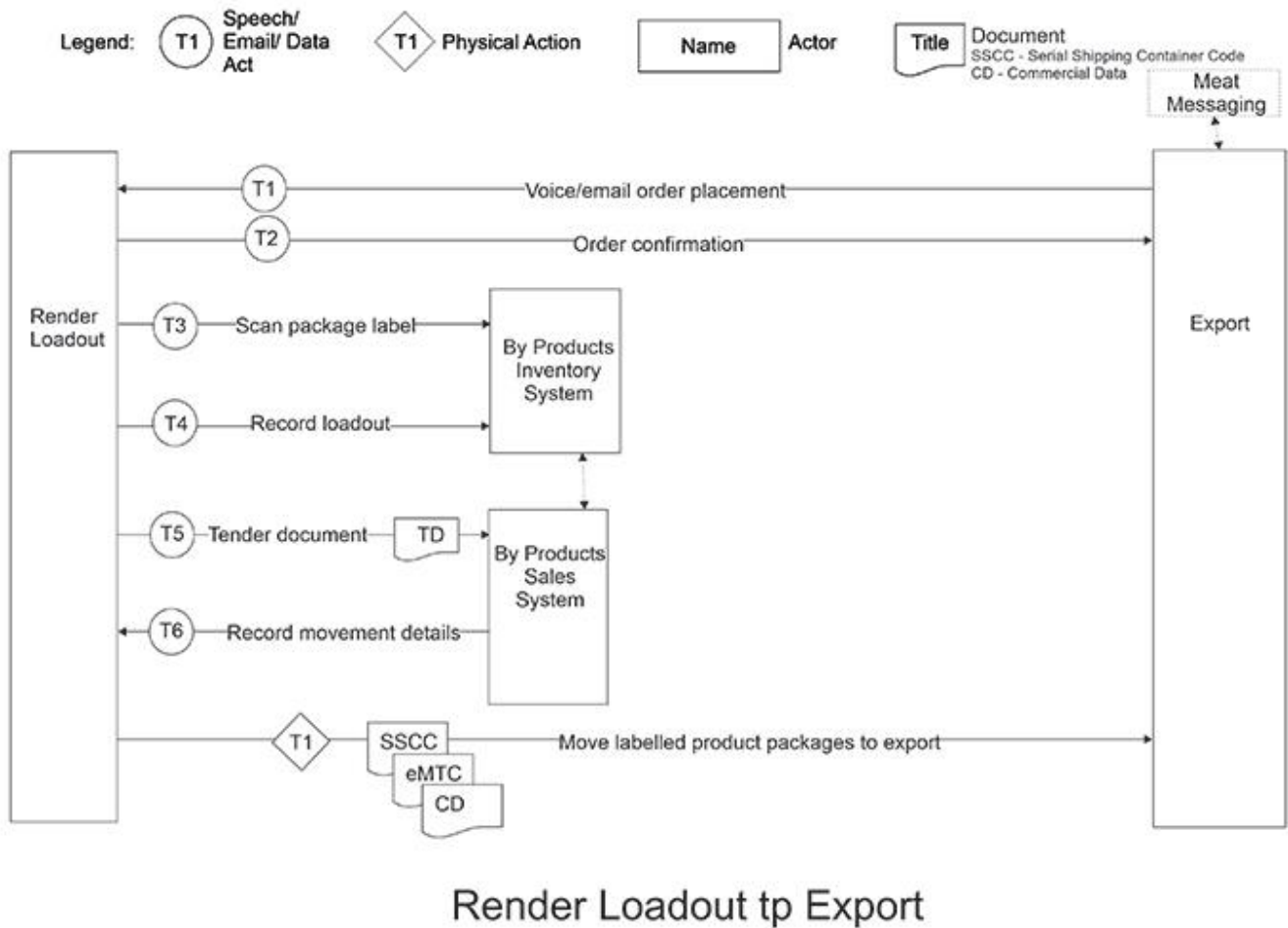

Figure 136. Data or information flows from the render loadout to export systems in the small stock supply chain.

5.2.5.3.7.6 Hides to Export

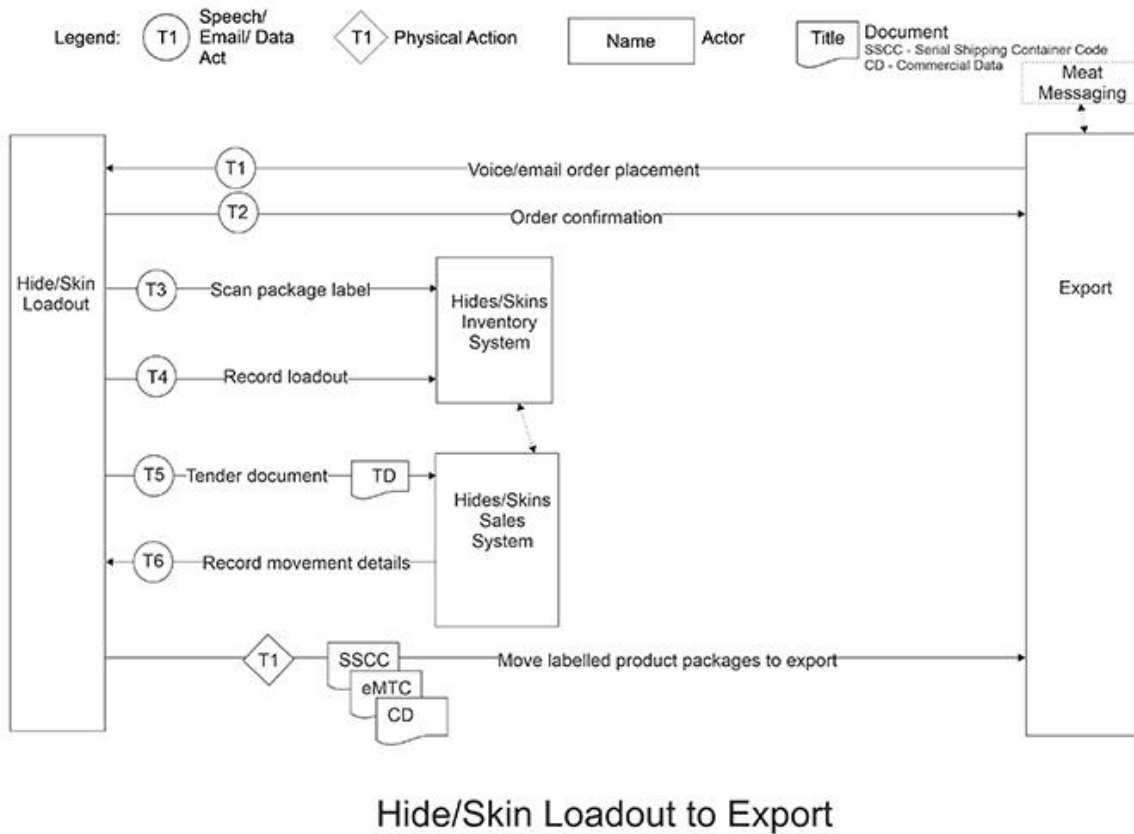

Figure 137. Data or information flows from the hide/skin loadout to export systems in the small stock supply chain.

5.2.5.3.7.7 Export to Import Inspection Facility

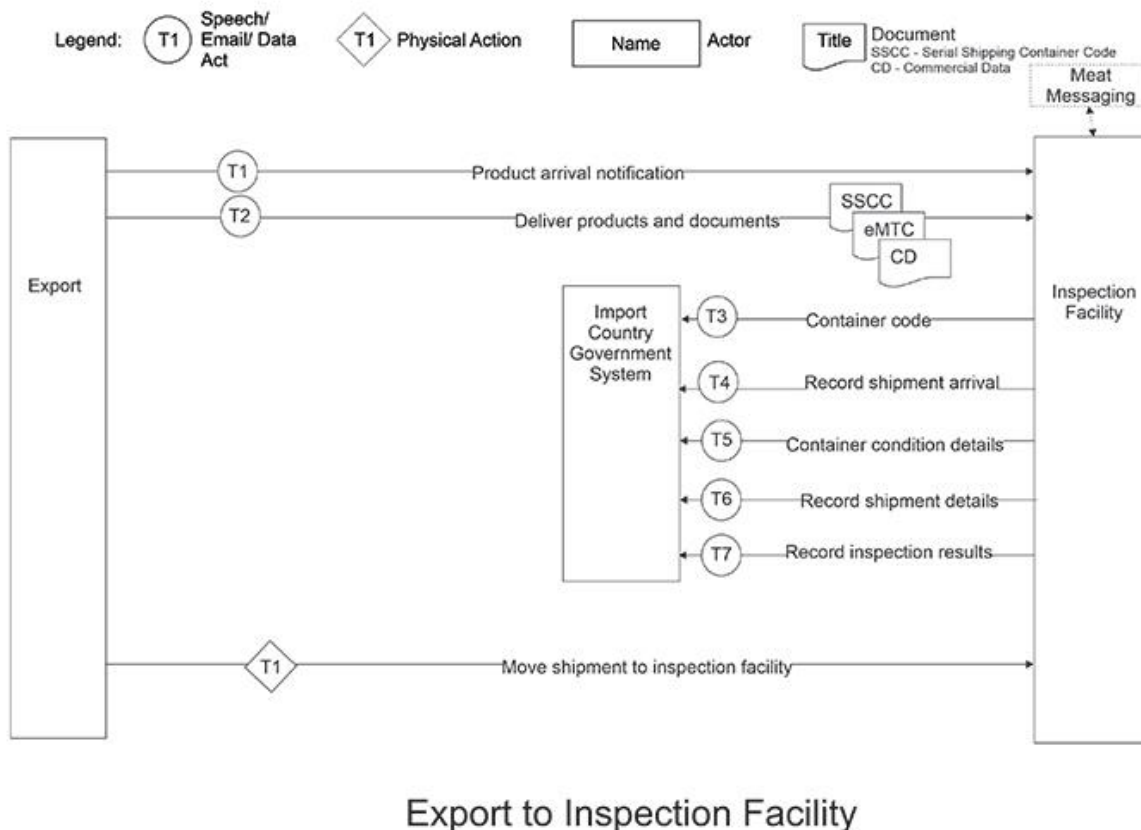

Figure 138. Data or information flows from the export to import inspection facility systems in the small stock supply chain.

5.2.6 Importing Country - National distribution

5.2.6.1 Import finishing/backgrounding

Backgrounding allows livestock to grow to an appropriate weight for slaughter while finishing or lot-feeding systems aim to optimise growth. Backgrounding may be forage or fodder based with animals grazing on pasture, crop stubbles, or handfed roughage. Grain rations are typically of higher quality than grass pasture and therefore improve the live weight gain of animals. Therefore, some systems may also integrate a lot-feeding component (aka feedlot) where animals are fed grain-based rations to maximise growth. In backgrounding/finishing systems there are typically three methods of grain feeding which include lib access (self-feeding), restricted feeding and choice feeding. Further, these systems may also require nutritional supplements and health controls such as vaccination to ensure that livestock production efficiency and welfare are maximised.

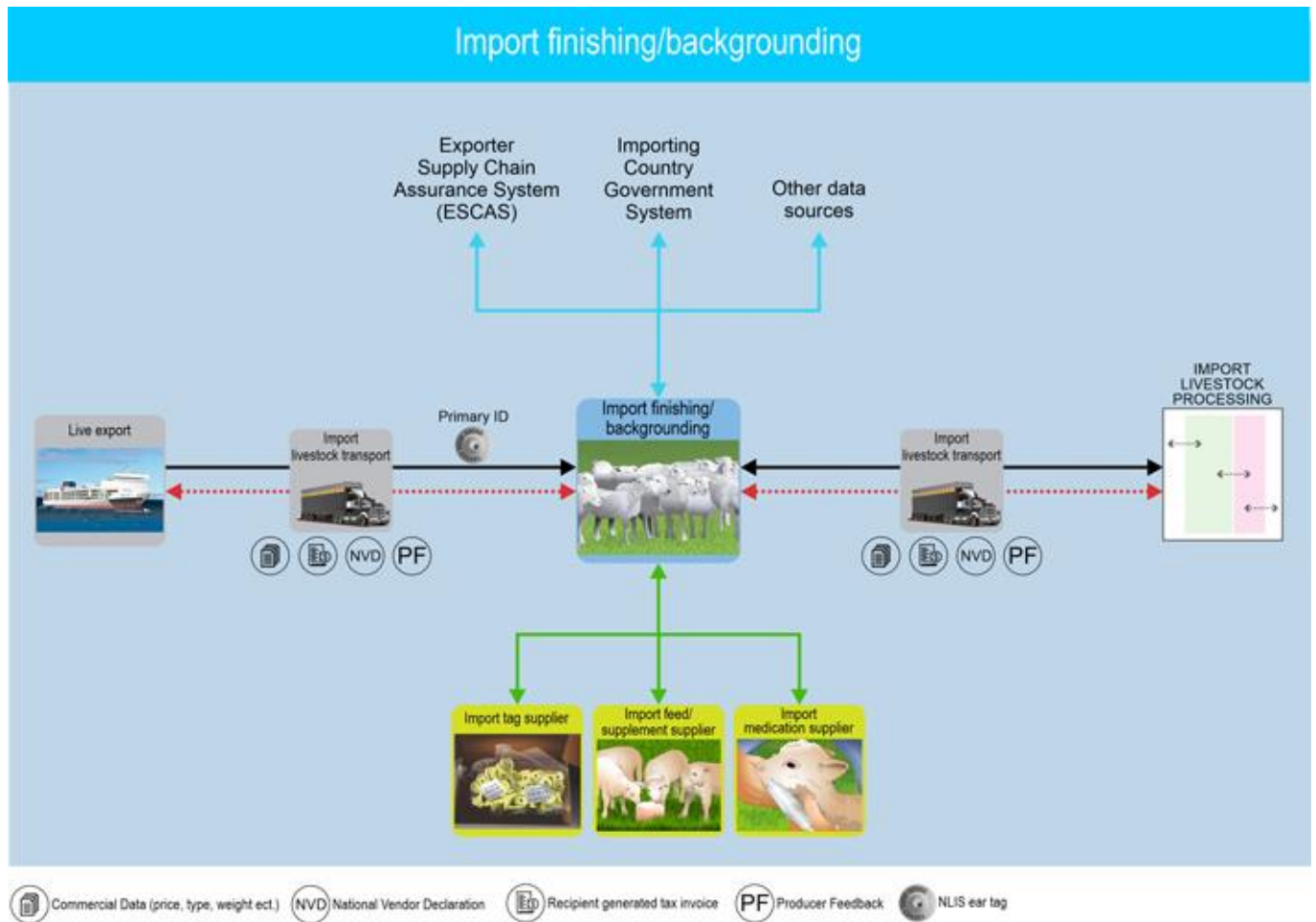

Figure 139. Inputs and outputs of the small stock supply chain import finishing/backgrounding sector.

5.2.6.1.1 Physical Inputs including Critical Tracking Events (CTEs)

Inputs for the finishing/backgrounding component of the small stock supply chain are largely the same as for the breeding and backgrounding sectors and include the livestock, any veterinary input or commercial services, veterinary drugs and health treatments, crop and pasture treatments and any feed supplements.

Critical Tracking Events (CTEs) are defined as those events which include the growing, receiving, transforming, creating, and shipping of food products. Such events are critical to the traceability of product throughout the supply chain.

The CTEs associated with inputs to the import finishing/backgrounding system include the receipt of:

- Small livestock
- Crop and pasture treatments
- Experts and veterinarians
- Feed supplies and supplements
- Veterinary drugs or other health treatments.

Table 119. Physical inputs and associated Critical Tracking Event related documents for a small stock import finishing/backgrounding system.

Event related to the inputs	Description of the inputs	Critical Tracking Event (CTE) related documents (including electronic)	More details
Small livestock	These are sheep or goat livestock and may include any class of animals e.g., weaners, ewe/nanny, ram/buck, cull livestock etc.	Exporter/Importer Agreement, Import feed and water record, Import Permit, Livestock Export Health Certificate, Veterinary Services Form/Import release, Import Receipt of purchase/Tax Invoice, Import specific livestock movement forms	
Crop and pasture treatments	These are agricultural chemicals applied to crops, pastures and/or paddocks (inclusive of spot spraying) which livestock may come into contact with or consume.	Import Receipt of purchase/Tax Invoice	
Experts and veterinarians	These are professionals who provide services to the breeding enterprise which ensure the safety, wellbeing, and productivity of the livestock.	Import Receipt of purchase/Tax Invoice, Veterinary prescription	
Feed supplies and supplements	These are supplementary animal feed products such as hay or silage fodder, or mineral supplements which are provided to ensure the production efficiency and health of livestock are maintained. This may also include clean drinking water e.g., where livestock are in transit or at saleyards.	Import specific commodity movement forms, Import Receipt of purchase/Tax Invoice	
Veterinary drugs or other health treatments	These may be prescribed, or non-prescribed treatments or medications given to ensure the health and wellbeing of the livestock.	Import Receipt of purchase/Tax Invoice, Veterinary prescription	

5.2.6.1.2 Information Inputs including Key Data Elements (KDEs)

Key Data Elements (KDEs) are defined as those elements which are key in identifying and tracing the Critical Tracking Event (CTE). There are a range of measurements that are related to the inputs of a finishing system. These include the source of the small stock, transport details, and any vaccinations or other treatments that the livestock have undergone. The importer of exported livestock must demonstrate that these livestock remain traceable throughout the supply chain up to the point of slaughter. Livestock must therefore be effectively identified, and all movements recorded to allow traceability back to the property of birth in the exporting country i.e., Australia. This requires import specific livestock movement forms to be completed and kept for traceability records.

Table 120. Information inputs, Key Data Elements and Critical Tracking Event related documentation for a small stock import finishing/backgrounding system.

Attributes (including KDEs)	Description of the Attributes (including KDEs)	Is a KDE	Critical Tracking Event (CTE) related documents (including electronic)	More details
APVMA approval number	This is a unique number allocated to each label by the APVMA.	Yes	Livestock Export Health Certificate	For more information visit the Australian

				Pesticides and Veterinary Medicine Authority.
Batch number	This is a unique number which identifies products sharing certain production characteristics and is used for traceability purposes.	Yes	Livestock Export Health Certificate	
Company/product code	This is an in-house code for the identification of the product in the unit.	Yes	Import feed and water record Import, Receipt of purchase/Tax Invoice	
Contract number	This is a unique number allocated to the contract by the seller.	Yes	Exporter/Importer Agreement, Import specific commodity movement forms	
Customs Entry number	A unique number assigned to an entry document and issued to importation shipments by customs for identification purposes.	Yes	Veterinary Services Form/Import release	
Date	This is the date of signing or of which a record entry or transaction was made.	Yes	Exporter/Importer Agreement, Import feed and water record, Import Receipt of purchase/Tax Invoice, Import specific commodity movement forms, Import specific livestock movement forms, Livestock Export Health Certificate	
Export Health Certificate Number	A unique number allocated to the health certificate issued for the export consignment for traceability purposes.	Yes	Livestock Export Health Certificate	For more information visit the Department of Agriculture, Water and the Environment website.
Export Premises Registration number	A unique number issued to Australian Government approved quarantine premises where livestock are prepared for export.	Yes	Livestock Export Health Certificate	For more information visit the Department of Agriculture, Water and the Environment website.
From Port Code	Any location used in international trade and transport (e.g., seaport, airports etc.) are issued with an identification code.	Yes	Livestock Export Health Certificate	
From property identifier	The identification of the property (may be a PIC) from/to where the livestock or product were consigned.	Yes	Import specific commodity movement forms, Import specific livestock movement forms	

Import Permit Number	A unique permit number is allocated for the import consignment following submission of correct and validated documentation approved by the importing country.	Yes	Import Permit, Veterinary Services Form/Import release	
Livestock Export Licence Holder number	A unique licence number is allocated to exporters of livestock for a period of one to five years following submission of a correct documentation which is then approved by the Secretary.	Yes	Exporter/Importer Agreement, Livestock Export Health Certificate	For more information visit the Department of Agriculture, Water and the Environment website.
Livestock Identifier	The importer of exported livestock must demonstrate that these livestock remain traceable throughout the supply chain up to the point of slaughter. Livestock must be effectively identified, and all movements recorded to allow traceability back to the property of birth in the exporting country.	Yes	Import specific livestock movement forms	
Livestock movement form serial number	A unique certificate number issued for traceability purposes.	Yes	Import specific livestock movement forms	
Movement date	The date on which livestock or other products (e.g., feed or meat products) were transported between PICs/establishments.	Yes	Exporter/Importer Agreement, Import specific commodity movement forms, Import specific livestock movement forms, Livestock Export Health Certificate, Veterinary Services Form/Import release	
NLIS Tag Number/RFID	All animals transported between PICs must have a permanent National Livestock Identification System tag attached. This tag has a unique animal identification number.	Yes	Livestock Export Health Certificate	For more information visit the Integrity systems website.
Prescription number	A unique certificate number issued for traceability purposes.	Yes	Veterinary prescription	
Product code/description	This is a unique identifier or description assigned by the seller to each product type marketed or for sale.	Yes	Import specific commodity movement forms	
Quarantine date range	This is the date range identifying a period in time in which livestock were quarantined directly prior to exportation.	Yes	Livestock Export Health Certificate	
Recipient Business Number	This is a unique registration number, used to identify businesses.	Yes	Import feed and water record, Import Receipt of purchase/Tax Invoice	

Seller/Supplier Business Number	This is a unique registration number, used to identify businesses.	Yes	Import feed and water record, Import Receipt of purchase/Tax Invoice	
To Port Code	Any location used in international trade and transport (e.g., seaport, airports etc.) are issued with an identification code.	Yes	Livestock Export Health Certificate, Veterinary Services Form/Import release	
To property identifier	The identification of the property (may be a PIC) from/to where the livestock or product were consigned.	Yes	Import specific commodity movement forms, Import specific livestock movement forms	
Transport registration number	The registration number of the vehicle in which the animals or product were transported.	Yes	Import specific livestock movement forms, Livestock Export Health Certificate, Veterinary Services Form/Import release	
Treatment date	The date on which a treatment or product was applied to a unit e.g., paddock, animal, fodder etc.	Yes	Import feed and water record, Livestock Export Health Certificate	
Veterinary Registration Number	A unique number issued to veterinarians who are registered to practice, under the state legislative requirements, within the state in which they reside.	Yes	Livestock Export Health Certificate, Veterinary prescription	

5.2.6.1.3 Physical Outputs including Critical Tracking Events (CTEs)

The outputs from a finishing/backgrounding system are small stock that have been prepared for slaughter and are moved directly to a processor. There is information about each animal that should be made available to this next link in the supply chain. This information is normally passed forward on import specific livestock movement documents.

Critical Tracking Events (CTEs) are defined as those events which include the growing, receiving, transforming, creating, and shipping of food products. Such events are critical to the traceability of product throughout the supply chain.

The CTEs associated with the outputs of the import finishing/backgrounding system include the movement of:

- Small livestock

off the property, premises, or supply chain sector.

Table 121. Physical outputs and associated Critical Tracking Event related documents for a small stock import finishing/backgrounding system.

Event related to the inputs	Description of the inputs	Critical Tracking Event (CTE) related documents (including electronic)	More details
Small livestock	These are sheep or goat livestock and may include any class of animals e.g., weaners,	Commercial supply contract, Import feed and water record, Import specific livestock movement forms, Import Receipt of purchase/Tax Invoice	

	ewe/nanny, ram/buck, cull livestock etc.		
--	--	--	--

5.2.6.1.4 Information Outputs including Key Data Elements (KDEs)

Key Data Elements (KDEs) are defined as those elements which are key in identifying and tracing the Critical Tracking Event (CTE). Information passed forward to the next link in the supply chain from a finishing/backgrounding system is derived from regulated documents such as import specific livestock movement forms or other records such as feed and water records or commercial supply contracts.

Table 122. Information outputs, Key Data Elements and Critical Tracking Event related documentation for a small stock import finishing/backgrounding system.

Attributes (including KDEs)	Description of the Attributes (including KDEs)	Is a KDE	Critical Tracking Event (CTE) related documents (including electronic)	More details
Agreement date	This is the date on which an agreement between two parties was made.	Yes	Commercial supply contract	
Company/product code	This is an in-house code for the identification of the product in the unit.	Yes	Import feed and water record, Import Receipt of purchase/Tax Invoice	
Contract number	This is a unique number allocated to the contract by the seller.	Yes	Commercial supply contract	
Date	This is the date of signing or of which a record entry or transaction was made.	Yes	Commercial supply contract, Import feed and water record, Import Receipt of purchase/Tax Invoice, Import specific livestock movement forms	
From property identifier	The identification of the property (may be a PIC) from/to where the livestock or product were consigned.	Yes	Import specific livestock movement forms	
Livestock Identifier	The importer of exported livestock must demonstrate that these livestock remain traceable throughout the supply chain up to the point of slaughter. Livestock must be effectively identified, and all movements recorded to allow traceability back to the property of birth in the exporting country.	Yes	Import specific livestock movement forms	
Livestock movement form serial number	A unique certificate number issued for traceability purposes.	Yes	Import specific livestock movement forms	
Movement date	The date on which livestock or other products (e.g., feed or meat products) were transported between PICs/establishments.	Yes	Commercial supply contract, Import specific livestock movement forms	
Recipient Business Number	This is a unique registration number, used to identify businesses.	Yes	Import feed and water record, Import	For more information visit the

			Receipt of purchase/Tax Invoice	ATO website.
Seller/Supplier Business Number	This is a unique registration number, used to identify businesses.	Yes	Import feed and water record, Import Receipt of purchase/Tax Invoice	For more information visit the ATO website.
To property identifier	The identification of the property (may be a PIC) from/to where the livestock or product were consigned.	Yes	Import specific livestock movement forms	
Transport registration number	The registration number of the vehicle in which the animals or product were transported.	Yes	Import specific livestock movement forms	
Treatment date	The date on which a treatment or product was applied to a unit e.g., paddock, animal, fodder etc.	Yes	Import feed and water record	

5.2.6.1.5 Regulatory and Industry Programs

- Exporter Supply Chain Assurance System (ESCAS)
- Importing Country Government System
- Other data sources

5.2.6.1.6 Supply Chain Node Traceability

The National Livestock Identification System (NLIS) is the Australian livestock traceability program which is administered by Integrity Systems Company (ISC). Where stipulated by State legislation and certain export markets, the NLIS system requires all animals bought, sold, and moved along the supply chain to be tagged with an accredited NLIS ID tag. In some states, these tags require only the visual display of the Property Identification Code (PIC), while other states require each tag to have an individualised NLIS tag number or Radio Frequency Identifier (RFID) for the traceability of the animal throughout its lifetime. Every property which holds livestock must have a Property Identification Code (PIC) to which the livestock are assigned in the NLIS Database. Each time livestock are transferred between PICs within Australia they must be accompanied by a livestock movement declaration, such as the National Vendor Declaration (NVD) form. This document typically outlines the transporter details, consignment details, compliance with intended market specifications, withholding periods, and the details of the new property PIC. All livestock movements between PICs require an NLIS movement update to be made by either or both the consigner and receiver. Where NLIS ID tags are lost, livestock must be issued with a new post-breeder tag if not on the PIC of birth and this reconciled in the NLIS Database. For animals loaded for live export, it is the exporters responsibility to ensure that all livestock are transferred from the port PIC to EEEEEEEE (8Es) which signifies that livestock have been exported. The importer of exported livestock must demonstrate that these livestock remain traceable throughout the supply chain up to the point of slaughter. Livestock must be effectively identified, and all movements recorded to allow traceability back to the property of birth in the exporting country i.e., Australia.

5.2.6.1.7 Data flow diagrams

Table 123. Data flow diagrams for the inputs and outputs of a small stock import finishing/backgrounding.

Direction	Description
Input	Live Export to Import Finishing
Output	Import Finishing to Import Livestock Processing

5.2.6.1.7.1 Live Export to Import Finishing

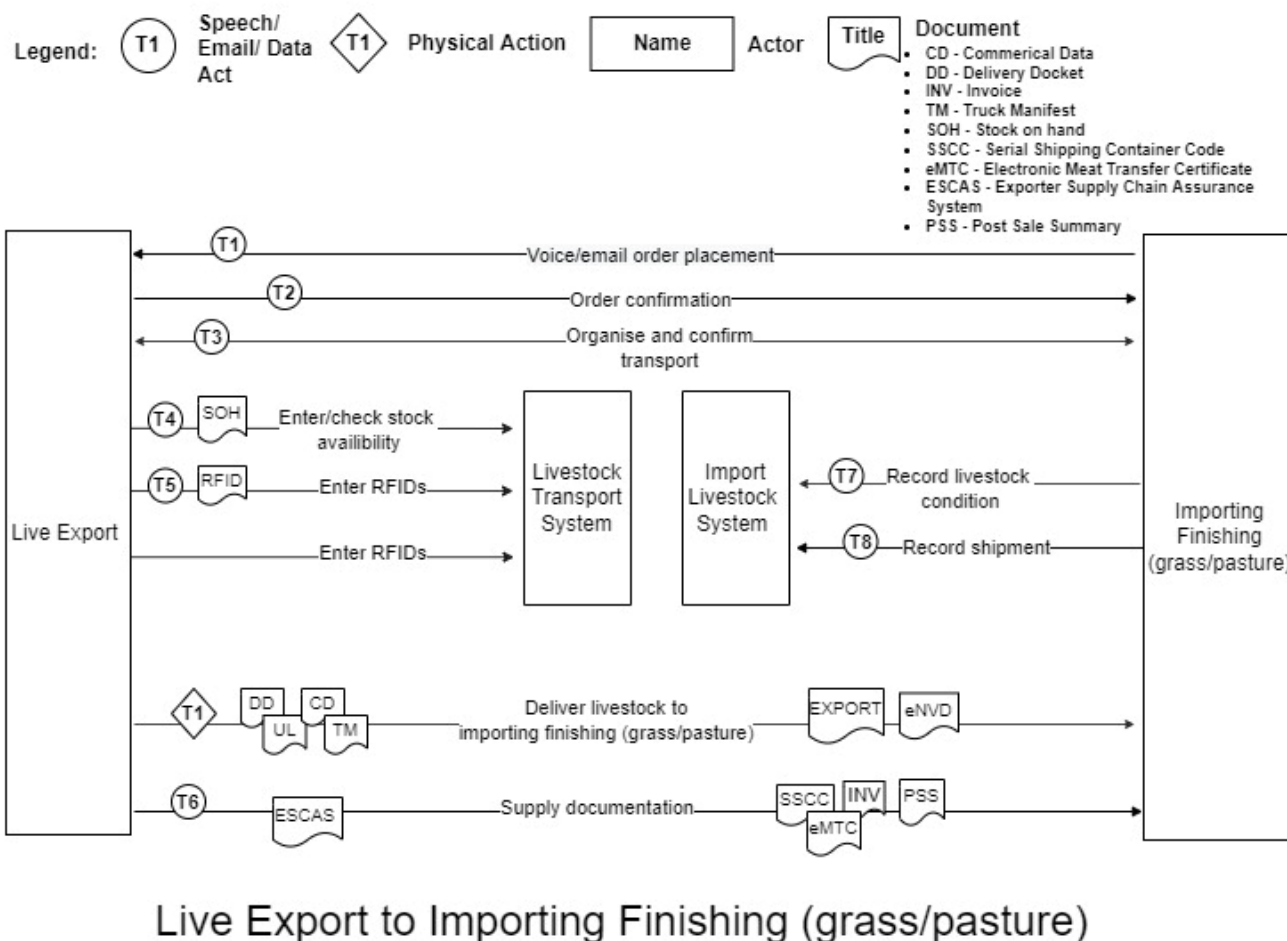

Figure 140. Data or information flows from live export to import finishing in the small stock supply chain.

5.2.6.1.7.2 Import Finishing to Import Livestock Processing

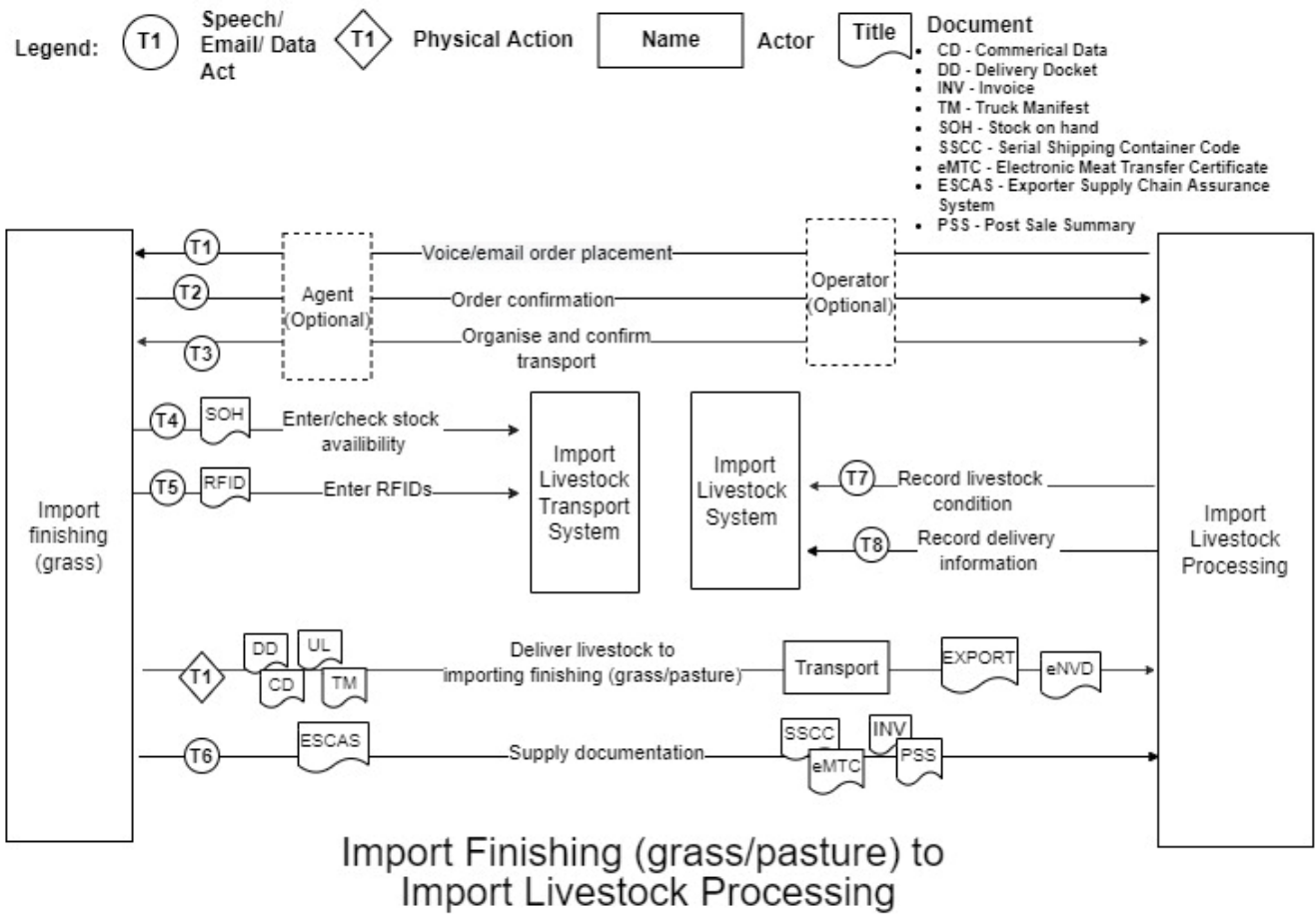

Figure 141. Data or information flows for import finishing (grass/pasture) to import livestock processing in the small stock supply chain.

5.2.6.2 Import inspection facility

After being exported from the country of origin, product first arrives at the import inspection facility. This is generally the port of entry where product and transportation documentation is checked for compliance with the importing country's requirements and biosecurity standards. This may include product inspection and sample analysis before being cleared for release into the importers domestic market.

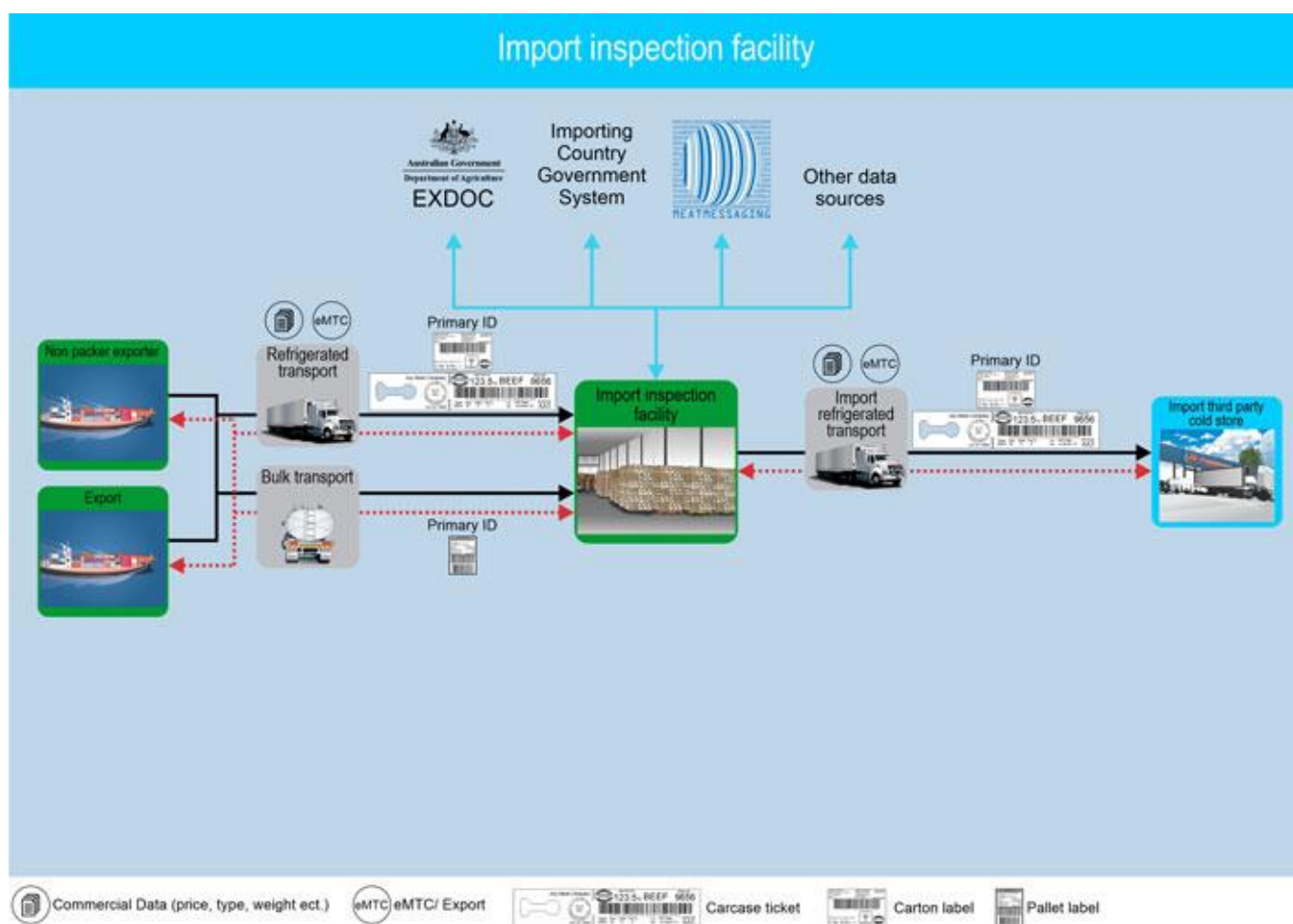

Figure 142. Inputs and outputs of the small stock supply chain import inspection facility sector.

5.2.6.2.1 Physical Inputs including Critical Tracking Events (CTEs)

Container system units, which contain packaged meat product, are the physical inputs into the importers inspection facility. Critical Tracking Event related documentation such as the Bill of lading/Air Waybill, as well as Export Health Certificate and Certificate of Analysis, must accompany the movement of product to an importing country. In addition, the importer may require an import permit and Food Control Certificate for edible product or other Import clearance documentation for non-prescribed goods.

Critical Tracking Events (CTEs) are defined as those events which include the growing, receiving, transforming, creating, and shipping of food products. Such events are critical to the traceability of product throughout the supply chain.

The CTEs associated with inputs to the import inspection facility system include the receipt of:

- Container System Unit (meat and meat products)
- Container System Unit (render and hide product).

Table 124. Physical inputs and associated Critical Tracking Event related documents for a small stock import inspection facility system.

Event related to the inputs	Description of the inputs	Critical Tracking Event (CTE) related documents (including electronic)	More details
-----------------------------	---------------------------	--	--------------

Container System Unit (meat and meat products)	A container designed for use as a unit of cargo handling equipment in the transport of goods by aircraft or ship.	Bill of lading/Air Waybill, Certificate of Analysis (COA), Delivery Docket/Manifest, Export Health Certificate, Export Permit, Meat Messaging Consignment Report, Meat Transfer Certificate (MTC), Official seal, Receipt of purchase/Tax Invoice	
Container System Unit (render and hide product)	A container designed for use as a unit of cargo handling equipment in the transport of goods by aircraft or ship.	Animal By Product Transfer Certificate (BPTC), Bill of lading/Air Waybill, Certificate of Analysis (COA), Delivery Docket/Manifest, Export clearance documentation, Export Permit, Meat Messaging Consignment Report, Receipt of purchase/Tax Invoice	

5.2.6.2.2 Information Inputs including Key Data Elements (KDEs)

Key Data Elements (KDEs) are defined as those elements which are key in identifying and tracing the Critical Tracking Event (CTE). Information inputs into the import inspection facility are those KDEs which can be drawn from CTE documentation. These may include document numbers for documents such as the Bill of lading/Air Waybill, Meat Transfer Certificate and Certificate of Analysis and Import clearance documentation as well as other product specific information.

Table 125. Information inputs, Key Data Elements and Critical Tracking Event related documentation for a small stock import inspection facility system.

Attributes (including KDEs)	Description of the Attributes (including KDEs)	Is a KDE	Critical Tracking Event (CTE) related documents (including electronic)	More details
Analysis Date	This is the date on which a product sample was analysed.	Yes	Certificate of Analysis (COA)	
Bill of lading/Air Waybill document number	A unique document number issued for traceability purposes.	Yes	Bill of lading/Air Waybill, Certificate of Analysis (COA)	
Certificate of Analysis number	A unique certificate number issued for traceability purposes.	Yes	Certificate of Analysis (COA)	
COA test lot identifier	This is a unique identifier allocated to all cartons, pallets, and shipping containers for which an analysis sample represents.	Yes	Certificate of Analysis (COA)	
Company/product code	This is an in-house code for the identification of the product in the unit.	Yes	Bill of lading/Air Waybill, Certificate of Analysis (COA), Receipt of purchase/Tax Invoice	
Consignment Serial Shipping Container Code (SSCC)	Encoded in the GS1 barcode, this is a unique number which identifies the individual logistic unit i.e., shipment/message that is assigned by the establishment constructing the unit. The SSCC remains the same for the life of the logistic unit.	Yes	Animal By Product Transfer Certificate (BPTC), Bill of lading/Air Waybill, Export clearance documentation, Meat Messaging Consignment Report, Meat Transfer Certificate (MTC)	For more information visit the GS1 website.
Contract number	This is a unique number allocated to the contract by the seller.	Yes	Delivery Docket/Manifest	
Count of Pallets	This is the number of pallets in the logistic unit e.g., container system unit.	Yes	Meat Messaging Consignment Report	

Count of Trade Items	Usually encoded in the GS1 barcode, this is the number of trade items e.g., cartons in the logistic unit.	Yes	Bill of lading/Air Waybill, Delivery Docket/Manifest, Meat Messaging Consignment Report	For more information visit the GS1 website.
Date	This is the date of signing or of which a record entry or transaction was made.	Yes	Animal By Product Transfer Certificate (BPTC), Bill of lading/Air Waybill, Certificate of Analysis (COA), Delivery Docket/Manifest, Export clearance documentation, Meat Messaging Consignment Report, Meat Transfer Certificate (MTC), Receipt of purchase/Tax Invoice	
Delivery Docket/Manifest number	This is a unique number allocated to the docket for identification purposes.	Yes	Delivery Docket/Manifest	
Export Health Certificate Number	A unique number allocated to the health certificate issued for the export consignment for traceability purposes.	Yes	Export Health Certificate, Meat Messaging Consignment Report	For more information visit the Department of Agriculture, Water and the Environment website.
Export Permit Number	A unique permit number is allocated for the export consignment following submission of a correct and validated Request For Permit (RFP) which is then approved by the Secretary.	Yes	Export Permit	For more information visit the Department of Agriculture, Water and the Environment website.
From Establishment number	A number issued by Federal and State Authorities to identify the originating site from which meat or meat products were distributed to domestic or export markets. For transfer certificates, the Establishment numbers for both the dispatching and receiving establishments are recorded.	Yes	Animal By Product Transfer Certificate (BPTC), Certificate of Analysis (COA), Delivery Docket/Manifest, Export clearance documentation, Export Health Certificate, Meat Messaging Consignment Report, Meat Transfer Certificate (MTC)	
Global Trade Item Number (GTIN)	Encoded in the GS1 barcode, the GTIN is a globally unique 14-digit number used to identify trade items, products, or services.	Yes	Meat Messaging Consignment Report	For more information visit the GS1 website.
Movement date	The date on which livestock or other products (e.g., feed or meat products) were transported between PICs/establishments.	Yes	Animal By Product Transfer Certificate (BPTC), Bill of lading/Air Waybill, Certificate of Analysis (COA), Delivery Docket/Manifest, Export clearance documentation, Export Health Certificate, Meat Transfer Certificate (MTC)	

MSA Licence Number	Any establishment consigning, supplying, or identifying MSA Certified Product must be registered and have a unique MSA Licence Number.	Yes	Receipt of purchase/Tax Invoice	For more information on MSA visit the MLA website.
Net Weight (Kilograms)	Usually encoded in the GS1 barcode, the Net Weight is a variable measure of the trade item e.g., carton, pallet or shipment recorded in kilograms.	Yes	Bill of lading/Air Waybill, Export Health Certificate, Meat Messaging Consignment Report	For more information visit the GS1 website.
Order date	This is the date on which the purchase order or contract was raised by the buyer.	Yes	Delivery Docket/Manifest	
Packaging Date	Encoded in the GS1 barcode, the Packaging Date is the date on which the item was packaged and is recorded in the format year, month, day (YYMMDD).	Yes	Certificate of Analysis (COA)	For more information visit the GS1 website.
Packaging Date Range	This includes the oldest and newest packaging dates for the logistic unit.	Yes	Export clearance documentation	For more information visit the GS1 website.
Pallet Serial Shipping Container Code (SSCC)	Encoded in the GS1 barcode, this is a unique number which identifies the individual logistic unit i.e., pallet that is assigned by the establishment constructing the unit. The SSCC remains the same for the life of the logistic unit.	Yes	Animal By Product Transfer Certificate (BPTC), Export clearance documentation, Meat Messaging Consignment Report, Meat Transfer Certificate (MTC)	For more information visit the GS1 website.
Production Date (YYMMDD)	Encoded in the GS1 barcode, this is the 'kill' or slaughter' date of the product and is recorded in the format year, month, day (YYMMDD).	Yes	Animal By Product Transfer Certificate (BPTC), Certificate of Analysis (COA), Meat Transfer Certificate (MTC)	For more information visit the GS1 website.
Recipient Australian Business Number (ABN)	This is an 11-digit registration number, issued by the Australian Tax Office, used to identify businesses.	Yes	Receipt of purchase/Tax Invoice	For more information visit the ATO website.
Seal Serial Number	This is a unique serial number printed on any tamper-evident seal issued by the Department.	Yes	Animal By Product Transfer Certificate (BPTC), Bill of lading/Air Waybill, Export clearance documentation, Meat Transfer Certificate (MTC), Official seal	For more information visit the Australian Government Federal Register of Legislation.
Seller/Supplier Australian Business Number (ABN)	This is an 11-digit registration number, issued by the Australian Tax Office, used to identify businesses.	Yes	Receipt of purchase/Tax Invoice	For more information visit the ATO website.
Shipping Mark	Also known as a port mark, this is a code comprising of three letters representing the foreign establishment number and the last	Yes	Bill of lading/Air Waybill, Certificate of Analysis (COA), Delivery Docket/Manifest, Export Health Certificate, Meat Messaging Consignment Report	

	nine digits of the consignment SSCC.			
To Establishment number	A number issued by Federal and State Authorities to identify the originating site from which meat or meat products were distributed to domestic or export markets. For transfer certificates, the Establishment numbers for both the dispatching and receiving establishments are recorded.	Yes	Animal By Product Transfer Certificate (BPTC), Export clearance documentation, Meat Transfer Certificate (MTC)	
Trade description	This is a collective set of words that says what the product is and may include information such as species, net weight of product, name and address of establishments, category ciphers, market endorsements, MSA eating quality etc.	Yes	Animal By Product Transfer Certificate (BPTC), Delivery Docket/Manifest, Export clearance documentation, Export Health Certificate, Meat Messaging Consignment, Report Meat Transfer Certificate (MTC)	
Transfer Certificate number	A unique certificate number issued for traceability purposes.	Yes	Animal By Product Transfer Certificate (BPTC), Meat Messaging Consignment Report, Meat Transfer Certificate (MTC)	
Transport registration number	The registration number of the vehicle in which the animals or product were transported. For shipments of product this will be a shipping container number.	Yes	Animal By Product Transfer Certificate (BPTC), Bill of lading/Air Waybill, Delivery Docket/Manifest, Export clearance documentation, Export Health Certificate, Meat Messaging Consignment Report, Meat Transfer Certificate (MTC)	

5.2.6.2.3 Physical Outputs including Critical Tracking Events (CTEs)

Container system units, which contain packaged meat product, are the physical outputs of the importers inspection facility. Critical Tracking Event related documentation such as the Bill of lading/Air Waybill, as well as Export Health Certificate and Certificate of Analysis, must accompany the movement of product to an importing country. In addition, the importer may require an import permit and Food Control Certificate for edible product or other Import clearance documentation for non-prescribed goods.

Critical Tracking Events (CTEs) are defined as those events which include the growing, receiving, transforming, creating, and shipping of food products. Such events are critical to the traceability of product throughout the supply chain.

The CTEs associated with the outputs of the import inspection facility system include the movement of:

- Container System Unit (meat and meat products)
- Container System Unit (render and hide product)

off the property, premises, or supply chain sector.

Table 126. Physical outputs and associated Critical Tracking Event related documents for a small stock import inspection facility system.

Event related to the inputs	Description of the inputs	Critical Tracking Event (CTE) related documents (including electronic)	More details
Container System Unit (meat and meat products)	A container designed for use as a unit of cargo handling equipment in the transport of goods by aircraft or ship.	Bill of lading/Air Waybill, Certificate of Analysis (COA), Delivery Docket/Manifest, Export Health Certificate, Export Permit, Food Control Certificate, Import Permit, Imported Food Inspection Advice, Meat Messaging Consignment Report, Meat Transfer Certificate (MTC), Official seal, Receipt of purchase/Tax Invoice	
Container System Unit (render and hide product)	A container designed for use as a unit of cargo handling equipment in the transport of goods by aircraft or ship.	Animal By Product Transfer Certificate (BPTC), Bill of lading/Air Waybill, Certificate of Analysis (COA), Delivery Docket/Manifest, Export clearance documentation, Export Permit, Import clearance documentation, Import Permit, Meat Messaging Consignment Report, Receipt of purchase/Tax Invoice	

5.2.6.2.4 Information Outputs including Key Data Elements (KDEs)

Key Data Elements (KDEs) are defined as those elements which are key in identifying and tracing the Critical Tracking Event (CTE). Information outputs from the import inspection facility are those KDEs which can be drawn from CTE documentation. These may include document numbers for documents such as the Bill of lading/Air Waybill, Meat Transfer Certificate and Certificate of Analysis and Import clearance documentation as well as other product specific information.

Table 127. Information outputs, Key Data Elements and Critical Tracking Event related documentation for a small stock import inspection facility system.

Attributes (including KDEs)	Description of the Attributes (including KDEs)	Is a KDE	Critical Tracking Event (CTE) related documents (including electronic)	More details
Analysis Date	This is the date on which a product sample was analysed.	Yes	Certificate of Analysis (COA), Imported Food Inspection Advice	
Bill of lading/Air Waybill document number	A unique document number issued for traceability purposes.	Yes	Bill of lading/Air Waybill, Certificate of Analysis (COA)	
Certificate of Analysis number	A unique certificate number issued for traceability purposes.	Yes	Certificate of Analysis (COA), Imported Food Inspection Advice	
COA test lot identifier	This is a unique identifier allocated to all cartons, pallets and shipping containers for which an analysis sample represents.	Yes	Certificate of Analysis (COA), Imported Food Inspection Advice	
Company/product code	This is an in-house code for the identification of the product in the unit.	Yes	Bill of lading/Air Waybill, Certificate of Analysis (COA), Imported Food Inspection Advice, Receipt of purchase/Tax Invoice	
Consignment Serial Shipping Container Code (SSCC)	Encoded in the GS1 barcode, this is a unique number which identifies the individual logistic unit i.e., shipment/message that is assigned by the establishment	Yes	Animal By Product Transfer Certificate (BPTC), Bill of lading/Air Waybill, Export clearance documentation, Food Control Certificate, Import	For more information visit the GS1 website.

	constructing the unit. The SSCC remains the same for the life of the logistic unit.		clearance documentation, Imported Food Inspection Advice, Meat Messaging Consignment Report, Meat Transfer Certificate (MTC)	
Contract number	This is a unique number allocated to the contract by the seller.	Yes	Delivery Docket/Manifest	
Count of Pallets	This is the number of pallets in the logistic unit e.g., container system unit.	Yes	Meat Messaging Consignment Report	
Count of Trade Items	Usually encoded in the GS1 barcode, this is the number of trade items e.g., cartons in the logistic unit.	Yes	Bill of lading/Air Waybill, Delivery Docket/Manifest, Food Control Certificate, Imported Food Inspection Advice, Meat Messaging Consignment Report	For more information visit the GS1 website.
Date	This is the date of signing or of which a record entry or transaction was made.	Yes	Animal By Product Transfer Certificate (BPTC), Bill of lading/Air Waybill, Certificate of Analysis (COA), Delivery Docket/Manifest, Export clearance documentation, Food Control Certificate, Import clearance documentation, Meat Messaging Consignment Report, Receipt of purchase/Tax Invoice	
Delivery Docket/Manifest number	This is a unique number allocated to the docket for identification purposes.	Yes	Delivery Docket/Manifest	
Export Health Certificate Number	A unique number allocated to the health certificate issued for the export consignment for traceability purposes.	Yes	Export Health Certificate, Meat Messaging Consignment Report	For more information visit the Department of Agriculture, Water and the Environment website.
Export Permit Number	A unique permit number is allocated for the export consignment following submission of a correct and validated Request For Permit (RFP) which is then approved by the Secretary.	Yes	Export Permit	For more information visit the Department of Agriculture, Water and the Environment website.
Food Control Certificate entry number	This is a number assigned to the entry of a shipment of goods imported by the same owner at the same time which can be described by one import entry.	Yes	Food Control Certificate, Imported Food Inspection Advice	
From Establishment number	A number issued by Federal and State Authorities to identify the originating site from which meat or meat products were distributed to domestic or export markets.	Yes	Animal By Product Transfer Certificate (BPTC), Certificate of Analysis (COA), Delivery Docket/Manifest, Export clearance documentation, Export	

	For transfer certificates, the Establishment numbers for both the dispatching and receiving establishments are recorded.		Health Certificate, Import clearance documentation, Meat Messaging Consignment Report, Meat Transfer Certificate (MTC)	
Global Trade Item Number (GTIN)	Encoded in the GS1 barcode, the GTIN is a globally unique 14-digit number used to identify trade items, products, or services.	Yes	Meat Messaging Consignment Report	For more information visit the GS1 website.
Import Permit Number	A unique permit number is allocated for the import consignment following submission of correct and validated documentation approved by the importing country.	Yes	Import Permit	
Imported Food Inspection Advice certificate number	A unique certificate number issued for traceability purposes.	Yes	Imported Food Inspection Advice	
Movement date	The date on which livestock or other products (e.g., feed or meat products) were transported between PICs/establishments.	Yes	Animal By Product Transfer Certificate (BPTC), Bill of lading/Air Waybill, Certificate of Analysis (COA), Delivery Docket/Manifest, Export clearance documentation, Export Health Certificate, Food Control Certificate, Import clearance documentation, Meat Transfer Certificate (MTC)	
MSA Licence Number	Any establishment consigning, supplying, or identifying MSA Certified Product must be registered and have a unique MSA Licence Number.	Yes	Receipt of purchase/Tax Invoice	For more information on MSA visit the MLA website.
Net Weight (Kilograms)	Usually encoded in the GS1 barcode, the Net Weight is a variable measure of the trade item e.g., carton, pallet or shipment recorded in kilograms.	Yes	Bill of lading/Air Waybill, Export Health Certificate, Meat Messaging Consignment Report	For more information visit the GS1 website.
Order date	This is the date on which the purchase order or contract was raised by the buyer.	Yes	Delivery Docket/Manifest	
Packaging Date	Encoded in the GS1 barcode, the Packaging Date is the date on which the item was packaged and is recorded in the format year, month, day (YYMMDD).	Yes	Certificate of Analysis (COA)	For more information visit the GS1 website.
Packaging Date Range	This includes the oldest and newest packaging dates for the logistic unit.	Yes	Export clearance documentation, Import clearance documentation	For more information visit the GS1 website.
Pallet Serial Shipping Container Code (SSCC)	Encoded in the GS1 barcode, this is a unique number which identifies the individual logistic unit i.e., pallet that is assigned by	Yes	Animal By Product Transfer Certificate (BPTC), Export clearance documentation, Import clearance	For more information visit the GS1 website.

	the establishment constructing the unit. The SSCC remains the same for the life of the logistic unit.		documentation, Meat Messaging Consignment Report, Meat Transfer Certificate (MTC)	
Production Date (YYMMDD)	Encoded in the GS1 barcode, this is the 'kill' or slaughter' date of the product and is recorded in the format year, month, day (YYMMDD).	Yes	Animal By Product Transfer Certificate (BPTC), Certificate of Analysis (COA), Meat Transfer Certificate (MTC)	For more information visit the GS1 website.
Recipient Australian Business Number (ABN)	This is an 11-digit registration number, issued by the Australian Tax Office, used to identify businesses.	Yes	Receipt of purchase/Tax Invoice	For more information visit the ATO website.
Seal Serial Number	This is a unique serial number printed on any tamper-evident seal issued by the Department.	Yes	Animal By Product Transfer Certificate (BPTC), Bill of lading/Air Waybill, Export clearance documentation, Import clearance documentation, Meat Transfer Certificate (MTC), Official seal	For more information visit the Australian Government Federal Register of Legislation.
Seller/Supplier Australian Business Number (ABN)	This is an 11-digit registration number, issued by the Australian Tax Office, used to identify businesses.	Yes	Receipt of purchase/Tax Invoice	For more information visit the ATO website.
Shipping Mark	Also known as a port mark, this is a code comprising of three letters representing the foreign establishment number and the last nine digits of the consignment SSCC.	Yes	Bill of lading/Air Waybill, Certificate of Analysis (COA), Delivery Docket/Manifest, Export Health Certificate, Meat Messaging Consignment Report	
To Establishment number	A number issued by Federal and State Authorities to identify the originating site from which meat or meat products were distributed to domestic or export markets. For transfer certificates, the Establishment numbers for both the dispatching and receiving establishments are recorded.	Yes	Animal By Product Transfer Certificate (BPTC), Export clearance documentation, Import clearance documentation, Meat Transfer Certificate (MTC)	
Trade description	This is a collective set of words that says what the product is and may include information such as species, net weight of product, name and address of establishments, category ciphers, market endorsements, MSA eating quality etc.	Yes	Animal By Product Transfer Certificate (BPTC), Delivery Docket/Manifest, Export clearance documentation, Export Health Certificate, Food Control Certificate, Import clearance documentation, Meat Messaging Consignment Report, Meat Transfer Certificate (MTC)	
Transfer Certificate number	A unique certificate number issued for traceability purposes.	Yes	Animal By Product Transfer Certificate (BPTC), Meat Messaging Consignment Report, Meat Transfer Certificate (MTC)	

Transport registration number	The registration number of the vehicle in which the animals or product were transported. For shipments of product this will be a shipping container number.	Yes	Animal By Product Transfer Certificate (BPTC), Bill of lading/Air Waybill, Delivery Docket/Manifest, Export clearance documentation, Export Health Certificate, Food Control Certificate, Import clearance documentation, Meat Messaging Consignment Report, Meat Transfer Certificate (MTC)	
-------------------------------	---	-----	--	--

5.2.6.2.5 Regulatory and Industry Programs

- Export Documentation System (EXDOC)
- Importing Country Government System
- Meat Messaging
- Other data sources

5.2.6.2.6 Supply Chain Node Traceability

The traceability of product undergoing export/importation back to the live animal, or consignment group and property of origin is dependent on the form (carcase, carton, pallet or render store bag subunits) in which the product is being exported/imported. All container system units undergoing export must be accompanied by a Meat Messaging Consignment Report and a Meat Transfer Certificate (MTC) or Animal By Product Transfer Certificate (BPTC). The Consignment Report is issued to the buyer of product and lists all the logistic unit and subunit unique serialised identifiers contained within the Container System Unit including the Consignment Serial Shipping Container Code (SSCC), Pallet Serial Shipping Container Code, and scanned and verified carton label serial identifiers. Additionally, the Transfer Certificate details the serialised logistic unit identifiers such as the Serial Shipping Container Code (SSCC). These documents allow traceability of the unit and its subunits back to either the live animal and property of origin (for carcasses) or processor production run (for cartons and palletised meat and meat products).

For traceability information pertaining to render and hide products please refer to 'Supply Chain Node Traceability' under each of these nodes. For carton and carcase products please refer to Boning Room and Carcase Chiller 'Supply Chain Node Traceability' respectively.

5.2.6.2.7 Data flow diagrams

Table 128. Data flow diagrams for the inputs and outputs of a small stock import inspection facility system.

Direction	Description
Input	Export to Import Inspection Facility
Output	Import Inspection Facility to Third Party Cold Store

5.2.6.2.7.1 Export to Import Inspection Facility

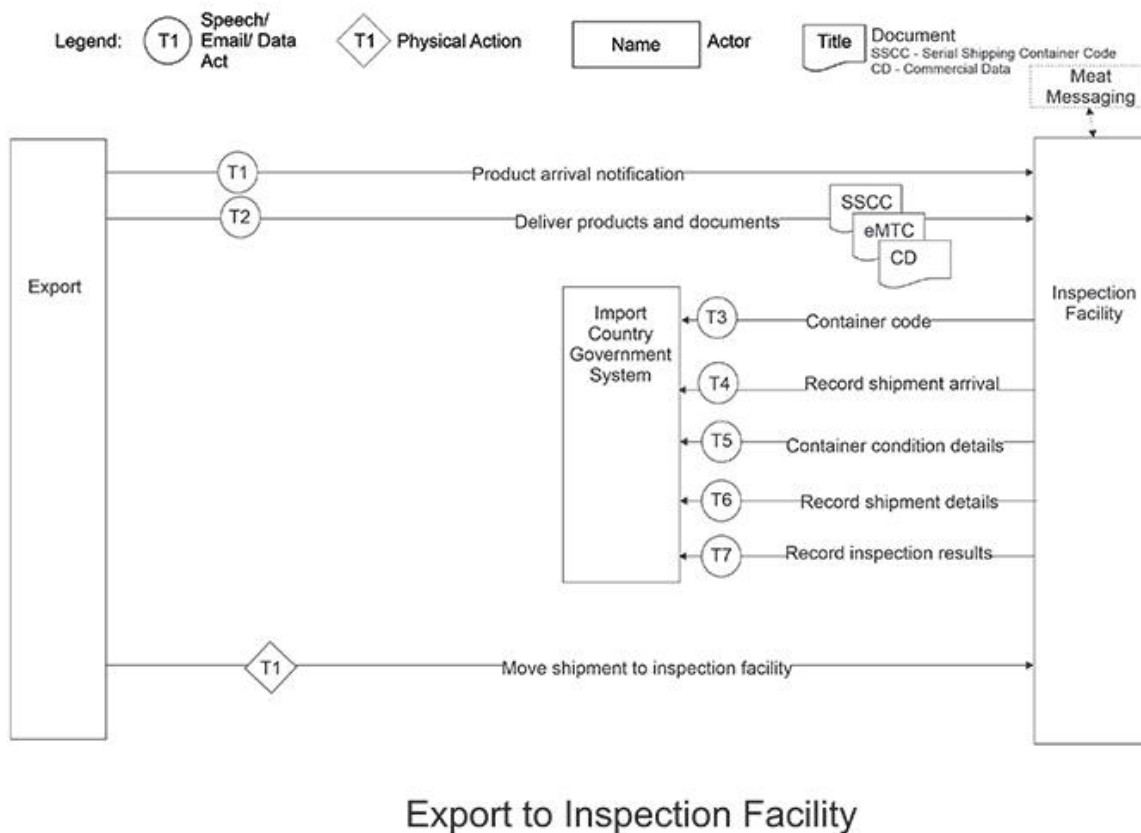

Figure 143. Data or information flows from the export to import inspection facility systems in the small stock supply chain.

5.2.6.2.7.2 Import Inspection Facility to Third Party Cold Store

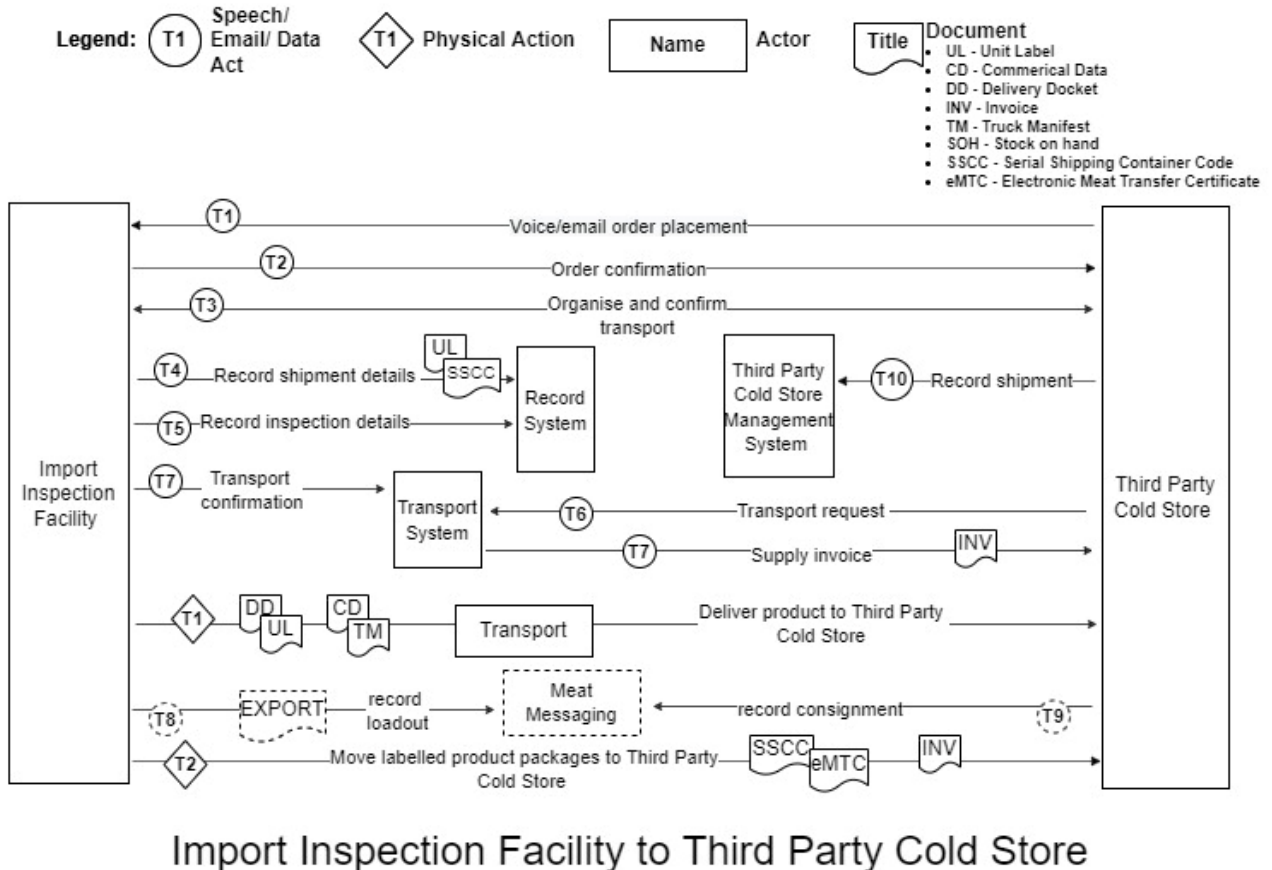

Figure 144. Data or information flow from import inspection facility to third party cold store in the small stock supply chain.

5.2.6.3 Import livestock processing

See Exporting Country - Processing for more information.

5.2.6.4 Import value-added

Value-adding includes any process or service in the supply chain that adds to or enhances the value of products to consumers and typically the profitability of raw meat products. This may be simply providing a new variety of cuts, changing the presentation of products, or adding additional ingredients to create new products or enhance the profitability of raw products. Value-adding may also include the processing of offal and raw products for sale. Typically, value adds receive carcase or cartoned product from processor cold stores, or third-party cold store facilities via refrigerated transport.

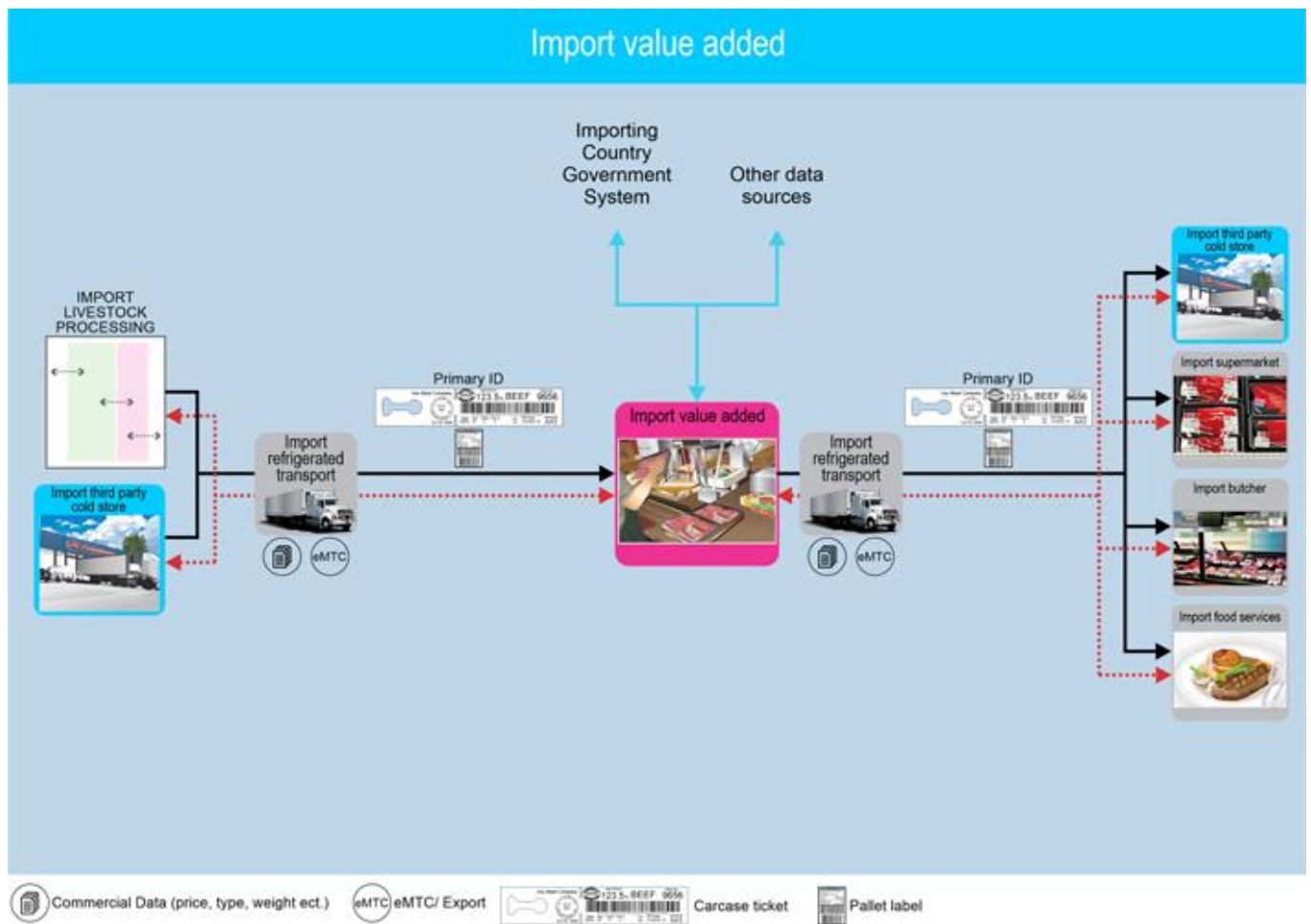

Figure 145. Inputs and outputs of the small stock supply chain import value-added sector.

5.2.6.4.1 Physical Inputs including Critical Tracking Events (CTEs)

Inputs into the value added system include raw meat products such as carcasses, carton and palletised items. Where additional ingredients are added to the product such as those used for marinade, these are also inputs to the system. Documentation associated with the movement of product into the value added system may include Delivery Dockets, import specific meat/meat product movement forms, Import Receipt of purchase/Tax Invoice etc.

Critical Tracking Events (CTEs) are defined as those events which include the growing, receiving, transforming, creating and shipping of food products. Such events are critical to the traceability of product throughout the supply chain.

The CTEs associated with inputs to the import value added system include the receipt of:

- Carcase
- Carton
- Pallet
- Product additives.

Table 129. Physical inputs and associated Critical Tracking Event related documents for a small stock import value-added system.

Event related to the inputs	Description of the inputs	Critical Tracking Event (CTE) related documents (including electronic)	More details
Carcase	The body of a slaughtered animal after bleeding. Becomes a dressed carcass when hide/skin, head, feet, and offal are removed.	Carcass Ticket, Delivery Docket/Manifest, Import specific meat/meat product movement forms, Value Added production management system, Import Receipt of purchase/Tax Invoice	
Carton	This is a case, crate, or barrel of product.	Carton label, Delivery Docket/Manifest, Import specific meat/meat product movement forms, Value Added production management system, Import Receipt of purchase/Tax Invoice	
Pallet	A logistic unit which includes a number of cartons or goods items packed together for transport or storage purposes.	Delivery Docket/Manifest, Import specific meat/meat product movement forms, Value Added production management system, Import Receipt of purchase/Tax Invoice, SSCC/Pallet label	
Product additives	These are ingredients or additives used to enhance the value of raw meat product.	Import Receipt of purchase/Tax Invoice, Value Added production management system	

5.2.6.4.2 Information Inputs including Key Data Elements (KDEs)

Key Data Elements (KDEs) are defined as those elements which are key in identifying and tracing the Critical Tracking Event (CTE). Key Data Elements drawn from Critical Tracking Event documentation range from carcass body numbers to delivery docket numbers to application identifiers included in the GS1 barcode on the carton or pallet label. This information may be recorded in the value adder's production management system for product traceability purposes.

Table 130. Information inputs, Key Data Elements and Critical Tracking Event related documentation for a small stock import value-added system.

Attributes (including KDEs)	Description of the Attributes (including KDEs)	Is a KDE	Critical Tracking Event (CTE) related documents (including electronic)	More details
Batch number	This is a unique number which identifies products sharing certain production characteristics and is used for traceability purposes.	Yes	Carcass Ticket, Value Added production management system, Carcass Ticket, Value Added production management system	
Company/product code	This is an in-house code for the identification of the product in the unit.	Yes	Carton label, Import Receipt of purchase/Tax Invoice, SSCC/Pallet label, Value Added production management system	
Consignment Serial Shipping Container Code (SSCC)	Encoded in the GS1 barcode, this is a unique number which identifies the individual logistic unit i.e., shipment/message that is assigned by the establishment constructing the unit. The	Yes	Import specific meat/meat product movement forms, SSCC/Pallet label, Value	For more information visit the GS1 website.

	SSCC remains the same for the life of the logistic unit.		Added production management system	
Contract number	This is a unique number allocated to the contract by the seller.	Yes	Delivery Docket/Manifest, Value Added production management system	
Count of Trade Items	Usually encoded in the GS1 barcode, this is the number of trade items e.g., cartons in the logistic unit.	Yes	Delivery Docket/Manifest, SSCC/Pallet label, Value Added production management system	For more information visit the GS1 website.
Date	This is the date of signing or of which a record entry or transaction was made.	Yes	Delivery Docket/Manifest, Import Receipt of purchase/Tax Invoice, Import specific meat/meat product movement forms, Value Added production management system	
Delivery Docket/Manifest number	This is a unique number allocated to the docket for identification purposes.	Yes	Delivery Docket/Manifest, Value Added production management system	
From Establishment number	A number issued by Federal and State Authorities to identify the originating site from which meat or meat products were distributed to domestic or export markets. For transfer certificates, the Establishment numbers for both the dispatching and receiving establishments are recorded.	Yes	Carcase Ticket, Carton label, Delivery Docket/Manifest, SSCC/Pallet label, Value Added production management system	
From property identifier	The identification of the property (may be a PIC) from/to where the livestock or product were consigned.	Yes	Import specific meat/meat product movement forms, Value Added production management system	
Global Trade Item Number (GTIN)	Encoded in the GS1 barcode, the GTIN is a globally unique 14-digit number used to identify trade items, products, or services.	Yes	Carcase Ticket, Carton label, SSCC/Pallet label, Value Added production management system	For more information visit the GS1 website.
GTIN of Contained Trade Items	Encoded in the GS1 barcode, the GTIN of the contained trade items is a globally unique 14-digit number used to identify trade items, products, or services in the logistic unit.	Yes	SSCC/Pallet label, Value Added production management system	For more information visit the GS1 website.
Lot number	A lot is a number assigned by the processor to each group of livestock consigned to slaughter and is usually vendor specific.	Yes	Carcase Ticket, Value Added production management system	
Meat/meat product movement form number	A unique certificate number issued for traceability purposes.	Yes	Import specific meat/meat product movement forms, Value Added production management system	

Movement date	The date on which livestock or other products (e.g., feed or meat products) were transported between PICs/establishments.	Yes	Delivery Docket/Manifest, Import specific meat/meat product movement forms, Value Added production management system	
Net Weight (Kilograms)	Usually encoded in the GS1 barcode, the Net Weight is a variable measure of the trade item e.g., carton, pallet or shipment recorded in kilograms.	Yes	Carcase Ticket, Carton label, SSCC/Pallet label, Value Added production management system	For more information visit the GS1 website.
Official mark	Any stamp, seal, label, or mark that is declared by the regulations to be an official mark. An official mark signifies that the product has been inspected by and approved as safe for human consumption by an Authorised Officer.	Yes	Carcase Ticket, Carton label, SSCC/Pallet label, Value Added production management system	
Order date	This is the date on which the purchase order or contract was raised by the buyer.	Yes	Delivery Docket/Manifest, Value Added production management system	
Packaging Date	Encoded in the GS1 barcode, the Packaging Date is the date on which the item was packaged and is recorded in the format year, month, day (YYMMDD).	Yes	Carton label, SSCC/Pallet label, Value Added production management system	For more information visit the GS1 website.
Packaging Date Range	This includes the oldest and newest packaging dates for the logistic unit.	Yes	SSCC/Pallet label, Value Added production management system	For more information visit the GS1 website.
Pallet Serial Shipping Container Code (SSCC)	Encoded in the GS1 barcode, this is a unique number which identifies the individual logistic unit i.e., pallet that is assigned by the establishment constructing the unit. The SSCC remains the same for the life of the logistic unit.	Yes	Import specific meat/meat product movement forms, SSCC/Pallet label, Value Added production management system	For more information visit the GS1 website.
Production Date (YYMMDD)	Encoded in the GS1 barcode, this is the 'kill' or slaughter' date of the product and is recorded in the format year, month, day (YYMMDD).	Yes	Carcase Ticket, Import specific meat/meat product movement forms, Value Added production management system	For more information visit the GS1 website.
Recipient Business Number	This is a unique registration number, used to identify businesses.	Yes	Import Receipt of purchase/Tax Invoice, Value Added production management system	
Seller/Supplier Business Number	This is a unique registration number, used to identify businesses.	Yes	Import Receipt of purchase/Tax Invoice, Value Added production management system	
Serial Number	Encoded in the GS1 barcode, this is a code, numeric or alphanumeric, assigned to an individual instance of an item for its lifetime.	Yes	Carcase Ticket, Carton label, Value Added production management system	For more information visit the GS1 website.

Shipping Mark	Also known as a port mark, this is a code comprising of three letters representing the foreign establishment number and the last nine digits of the consignment SSCC.	Yes	Delivery Docket/Manifest, SSCC/Pallet label, Value Added production management system	
To property identifier	The identification of the property (may be a PIC) from/to where the livestock or product were consigned.	Yes	Import specific meat/meat product movement forms, Value Added production management system	
Trade description	This is a collective set of words that says what the product is and may include information such as species, net weight of product, name and address of establishments, category ciphers, market endorsements, MSA eating quality etc.	Yes	Carcase Ticket, Carton label, Delivery Docket/Manifest, SSCC/Pallet label, Value Added production management system	
Transport registration number	The registration number of the vehicle in which the animals or product were transported. For shipments of product this will be a shipping container number.	Yes	Delivery Docket/Manifest, Import specific meat/meat product movement forms, Value Added production management system	

5.2.6.4.3 Physical Outputs including Critical Tracking Events (CTEs)

The outputs of the value added system included altered meat product, with increased value, that is packed into cartons or pallets for distribution. Critical Tracking Event related documentation required for the movement of product may include Delivery Dockets, Import specific meat/meat product movement forms, Import Receipt of purchase/Tax Invoice etc.

Critical Tracking Events (CTEs) are defined as those events which include the growing, receiving, transforming, creating and shipping of food products. Such events are critical to the traceability of product throughout the supply chain.

The CTEs associated with the outputs of the import value added system include the movement of:

- Carton
- Pallet

off the property, premises, or supply chain sector.

Table 131. Physical outputs and associated Critical Tracking Event related documents for a small stock import value-added system.

Event related to the inputs	Description of the inputs	Critical Tracking Event (CTE) related documents (including electronic)	More details
Carton	This is a case, crate, or barrel of product.	Carton label, Delivery Docket/Manifest, Import specific meat/meat product movement forms, Value Added production management system, Import Receipt of purchase/Tax Invoice	

Pallet	A logistic unit which includes a number of cartons or goods items packed together for transport or storage purposes.	Delivery Docket/Manifest, Import specific meat/meat product movement forms, Value Added production management system, Import Receipt of purchase/Tax Invoice, SSCC/Pallet label	
--------	--	---	--

5.2.6.4.4 Information Outputs including Key Data Elements (KDEs)

Key Data Elements (KDEs) are defined as those elements which are key in identifying and tracing the Critical Tracking Event (CTE). Key Data Elements from value added Critical Tracking Event related documentation may be stored in the value adder’s production management system. Such information may include, but not be limited to, GS1 barcode application identifiers, movement dates, product net weight and import specific meat/meat product movement certificate numbers.

Table 132. Information outputs, Key Data Elements and Critical Tracking Event related documentation for a small stock import value-added system.

Attributes (including KDEs)	Description of the Attributes (including KDEs)	Is a KDE	Critical Tracking Event (CTE) related documents (including electronic)	More details
Company/product code	This is an in-house code for the identification of the product in the unit.	Yes	Carton label, Import Receipt of purchase/Tax Invoice, SSCC/Pallet label, Value Added production management system	
Consignment Serial Shipping Container Code (SSCC)	Encoded in the GS1 barcode, this is a unique number which identifies the individual logistic unit i.e., shipment/message that is assigned by the establishment constructing the unit. The SSCC remains the same for the life of the logistic unit.	Yes	Import specific meat/meat product movement forms, SSCC/Pallet label, Value Added production management system	For more information visit the GS1 website.
Contract number	This is a unique number allocated to the contract by the seller.	Yes	Delivery Docket/Manifest, Value Added production management system	
Count of Trade Items	Usually encoded in the GS1 barcode, this is the number of trade items e.g., cartons in the logistic unit.	Yes	Delivery Docket/Manifest, SSCC/Pallet label, Value Added production management system	For more information visit the GS1 website.
Date	This is the date of signing or of which a record entry or transaction was made.	Yes	Delivery Docket/Manifest, Import Receipt of purchase/Tax Invoice, Import specific meat/meat product movement forms, Value Added production management system	
Delivery Docket/Manifest number	This is a unique number allocated to the docket for identification purposes.	Yes	Delivery Docket/Manifest, Value Added production management system	

From Establishment number	A number issued by Federal and State Authorities to identify the originating site from which meat or meat products were distributed to domestic or export markets. For transfer certificates, the Establishment numbers for both the dispatching and receiving establishments are recorded.	Yes	Carton label, Delivery Docket/Manifest, SSCC/Pallet label, Value Added production management system	
From property identifier	The identification of the property (may be a PIC) from/to where the livestock or product were consigned.	Yes	Import specific meat/meat product movement forms, Value Added production management system	
Global Trade Item Number (GTIN)	Encoded in the GS1 barcode, the GTIN is a globally unique 14-digit number used to identify trade items, products, or services.	Yes	Carton label, SSCC/Pallet label, Value Added production management system	For more information visit the GS1 website.
GTIN of Contained Trade Items	Encoded in the GS1 barcode, the GTIN of the contained trade items is a globally unique 14-digit number used to identify trade items, products, or services in the logistic unit.	Yes	SSCC/Pallet label, Value Added production management system	For more information visit the GS1 website.
Meat/meat product movement form number	A unique certificate number issued for traceability purposes.	Yes	Import specific meat/meat product movement forms, Value Added production management system	
Movement date	The date on which livestock or other products (e.g., feed or meat products) were transported between PICs/establishments.	Yes	Delivery Docket/Manifest, Import specific meat/meat product movement forms, Value Added production management system	
Net Weight (Kilograms)	Usually encoded in the GS1 barcode, the Net Weight is a variable measure of the trade item e.g., carton, pallet or shipment recorded in kilograms.	Yes	Carton label, SSCC/Pallet label, Value Added production management system	For more information visit the GS1 website.
Official mark	Any stamp, seal, label, or mark that is declared by the regulations to be an official mark. An official mark signifies that the product has been inspected by and approved as safe for human consumption by an Authorised Officer.	Yes	Carton label, SSCC/Pallet label, Value Added production management system	
Order date	This is the date on which the purchase order or contract was raised by the buyer.	Yes	Delivery Docket/Manifest, Value Added production management system	
Packaging Date	Encoded in the GS1 barcode, the Packaging Date is the date on which the item was packaged and is recorded in the format year, month, day (YYMMDD).	Yes	Carton label, SSCC/Pallet label, Value Added production management system	For more information visit the GS1 website.

Packaging Date Range	This includes the oldest and newest packaging dates for the logistic unit.	Yes	SSCC/Pallet label, Value Added production management system	For more information visit the GS1 website.
Pallet Serial Shipping Container Code (SSCC)	Encoded in the GS1 barcode, this is a unique number which identifies the individual logistic unit i.e., pallet that is assigned by the establishment constructing the unit. The SSCC remains the same for the life of the logistic unit.	Yes	Import specific meat/meat product movement forms, SSCC/Pallet label, Value Added production management system	For more information visit the GS1 website.
Production Date (YYMMDD)	Encoded in the GS1 barcode, this is the 'kill' or slaughter' date of the product and is recorded in the format year, month, day (YYMMDD).	Yes	Import specific meat/meat product movement forms, Value Added production management system	For more information visit the GS1 website.
Recipient Business Number	This is a unique registration number, used to identify businesses.	Yes	Import Receipt of purchase/Tax Invoice, Value Added production management system	
Seller/Supplier Business Number	This is a unique registration number, used to identify businesses.	Yes	Import Receipt of purchase/Tax Invoice, Value Added production management system	
Serial Number	Encoded in the GS1 barcode, this is a code, numeric or alphanumeric, assigned to an individual instance of an item for its lifetime.	Yes	Carton label, Value Added production management system	For more information visit the GS1 website.
Shipping Mark	Also known as a port mark, this is a code comprising of three letters representing the foreign establishment number and the last nine digits of the consignment SSCC.	Yes	Delivery Docket/Manifest, SSCC/Pallet label, Value Added production management system	
To property identifier	The identification of the property (may be a PIC) from/to where the livestock or product were consigned.	Yes	Import specific meat/meat product movement forms, Value Added production management system	
Trade description	This is a collective set of words that says what the product is and may include information such as species, net weight of product, name and address of establishments, category ciphers, market endorsements, MSA eating quality etc.	Yes	Carton label, Delivery Docket/Manifest, SSCC/Pallet label, Value Added production management system	
Transport registration number	The registration number of the vehicle in which the animals or product were transported. For shipments of product this will be a shipping container number.	Yes	Delivery Docket/Manifest, Import specific meat/meat product movement forms, Value Added production management system	

5.2.6.4.5 Regulatory and Industry Programs

- Importing Country Government System

- Other data sources

5.2.6.4.6 Supply Chain Node Traceability

For Value Added operations the ability to trace product forward and track product backwards is defined by food safety regulations. In practice, this means that any prepared meat retail-ready or food service products are managed as a batch (with unique serialised carton labels or retail-ready product labels) with the inputs to the batch being all the carcass or carton identification units (carcass tickets/carton labels) that went into the batch. Should a recall occur related to any of the input material the whole value-added batch(s) would be recalled.

Tracing a single meat retail-ready or food service product (e.g., a portion prepared steak) back to a single animal or source property is operationally impractical. The example below shows the complexity of such a trace back.

Retail ready product traceability example:

1. The volume of retail-ready or food service product made in a batch would likely be in the order of 1 000 kg (50 x 20 kg primal cut cartons) which equates to 100 x 10 kg of finished retail-ready/food service cartons or approximately 2 000 x 500 g portioned steak packs. With each pack containing four steaks, this equates to 8 000 steaks. This is managed as a production batch and as such, any one steak in any carton may have come from any of the 50 x 20 kg primal cut cartons.
2. The cartons from which this retail-ready product (50 x 20 kg cartons) was produced may have been comprised of 1 000 kg of lamb leg primal cut cartons. These cartons might typically be sourced from 2 processing establishments and over 3 production days for each processing establishment, this is a total of 6 plant kill days.
3. The average weight of the lamb legs in each carton is 2.5 kg. This means that each carton has 8 lamb legs. With each carcass having 2 lamb legs, the 50 cartons may have been produced from 200 head of sheep.
4. Each processing plant might kill 5 000 head per day, and these might come from an average of 20 source properties. The traceability of cartoned boning room product is limited to the carcasses that have entered the boning room for the production run of cartons that are created. This means that the primal cut e.g., lamb leg in any carton may have come from any of the 5 000 carcasses for that boning run production day.
5. As the lamb leg primal cut cartons came from a total of 6 plant kill day combinations, this equates to any primal cut coming from any one of a possible 30 000 head of sheep or 120 possible source properties.

In summary, for this example, any individual 500 g portion cut steak pack may have come from any one or combination of 30 000 head of sheep from any one of 120 source properties. It is possible in some very small scale and very high value commercial operations to manage single body boning and tracking the cuts to retail-ready packaging. However, this would represent less than a fraction of a percent of the total meat industry production volume.

5.2.6.4.7 Data flow diagrams

Table 133. Data flow diagrams for the inputs and outputs of a small stock import value added system.

Direction	Description
Input	Import Third Party Cold Store to Import Value Added
Input	Import Refrigerated Transport to Import Value Added
Output	Import Value Added to Import Third Party Cold Store

Output	Import Value Added to Import Supermarket
Output	Import Value Added to Import Butcher
Output	Import Value Added to Import Food Services

5.2.6.4.7.1 Import Third Party Cold Store to Import Value Added

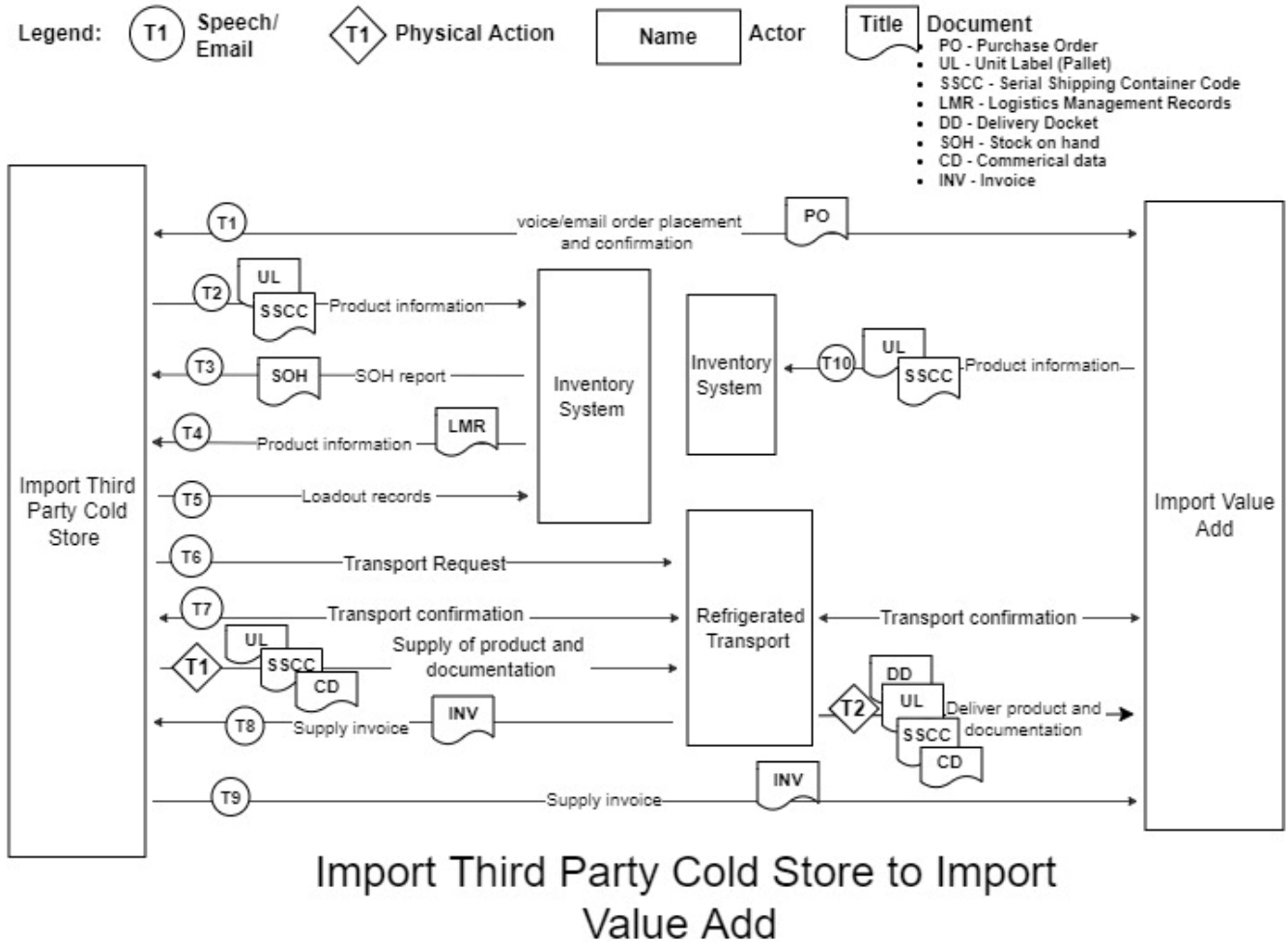

Figure 146. Data or information flows from the import third party cold store to import value added in the small stock supply chain.

5.2.6.4.7.2 Import Refrigerated Transport to Import Value Added

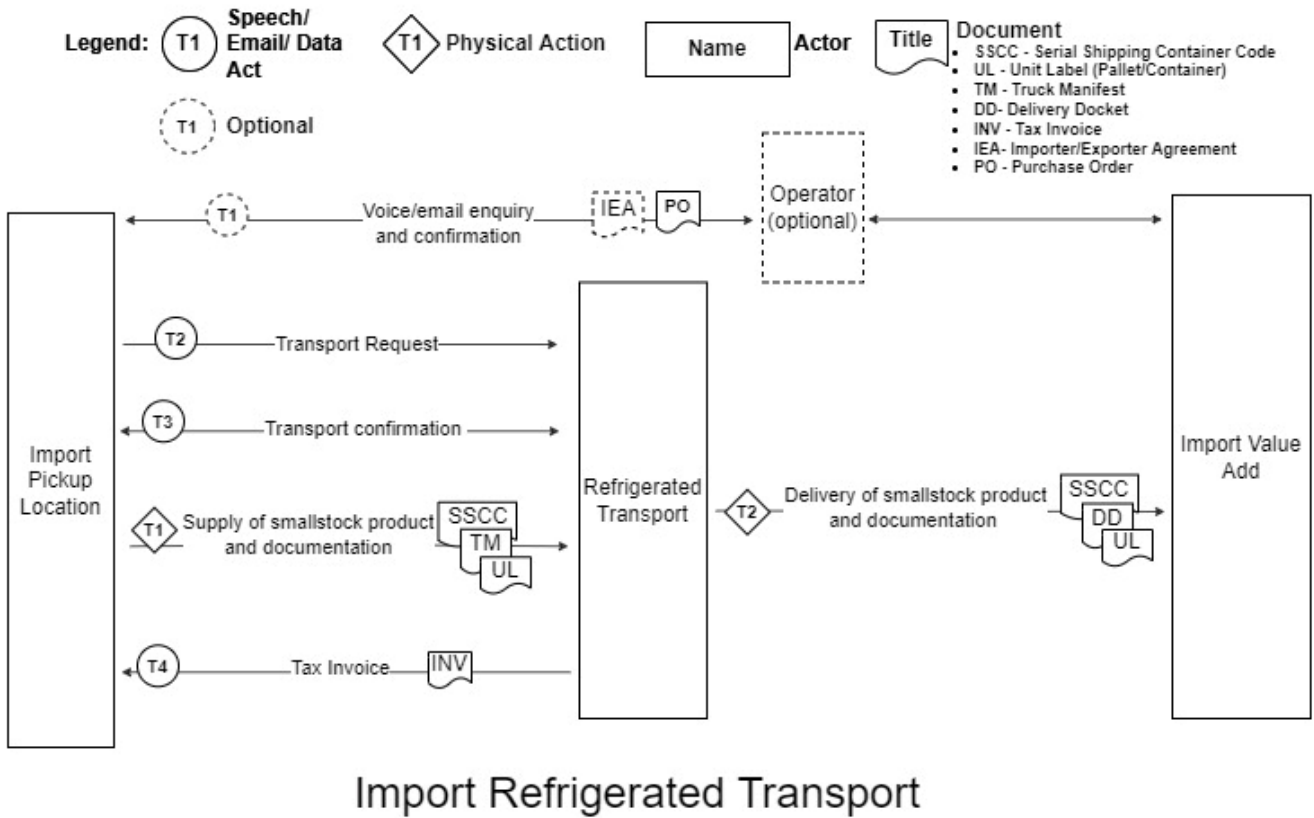

Figure 147. Data or information flows from the import refrigerated transport to import value added in the small stock supply chain.

5.2.6.4.7.3 Import Value Added to Import Third Party Cold Store

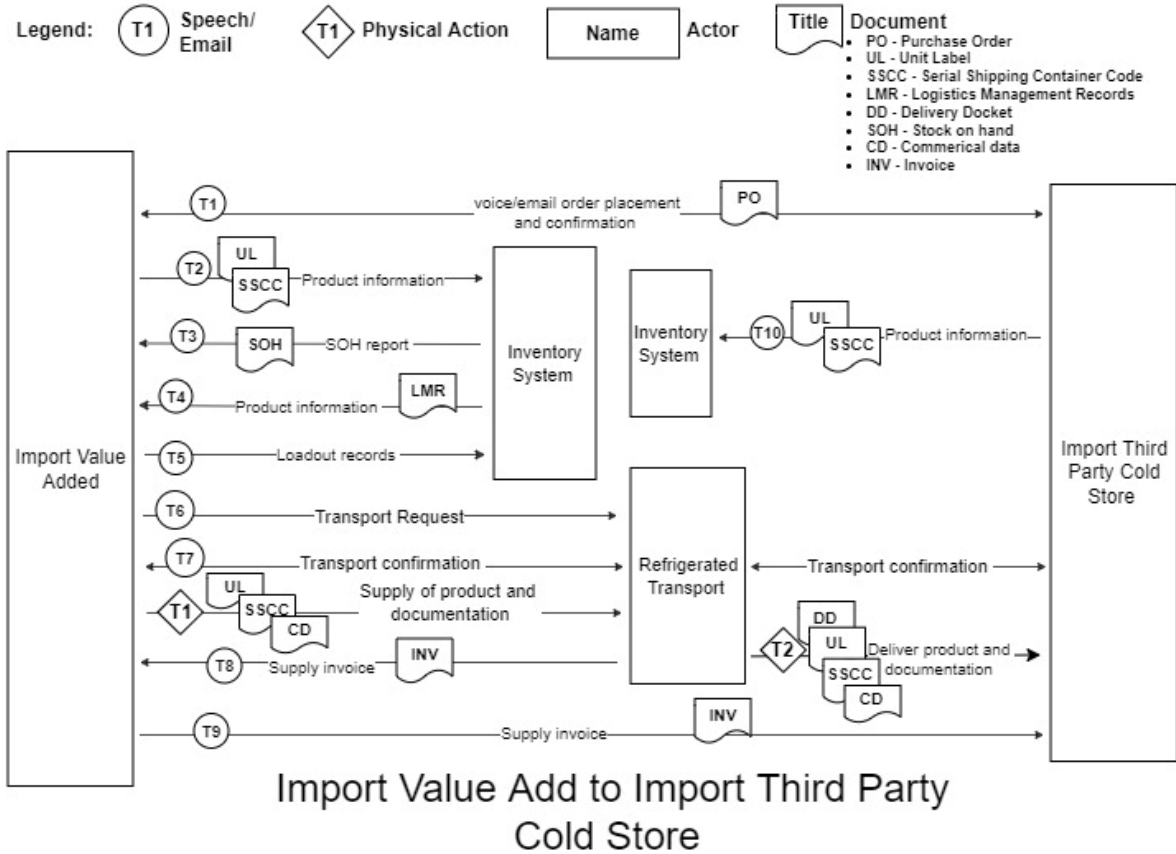

Figure 148. Data or information flows from the import value add to import third party cold store in the small stock supply chain.

5.2.6.4.7.4 Import Value Added to Import Supermarket

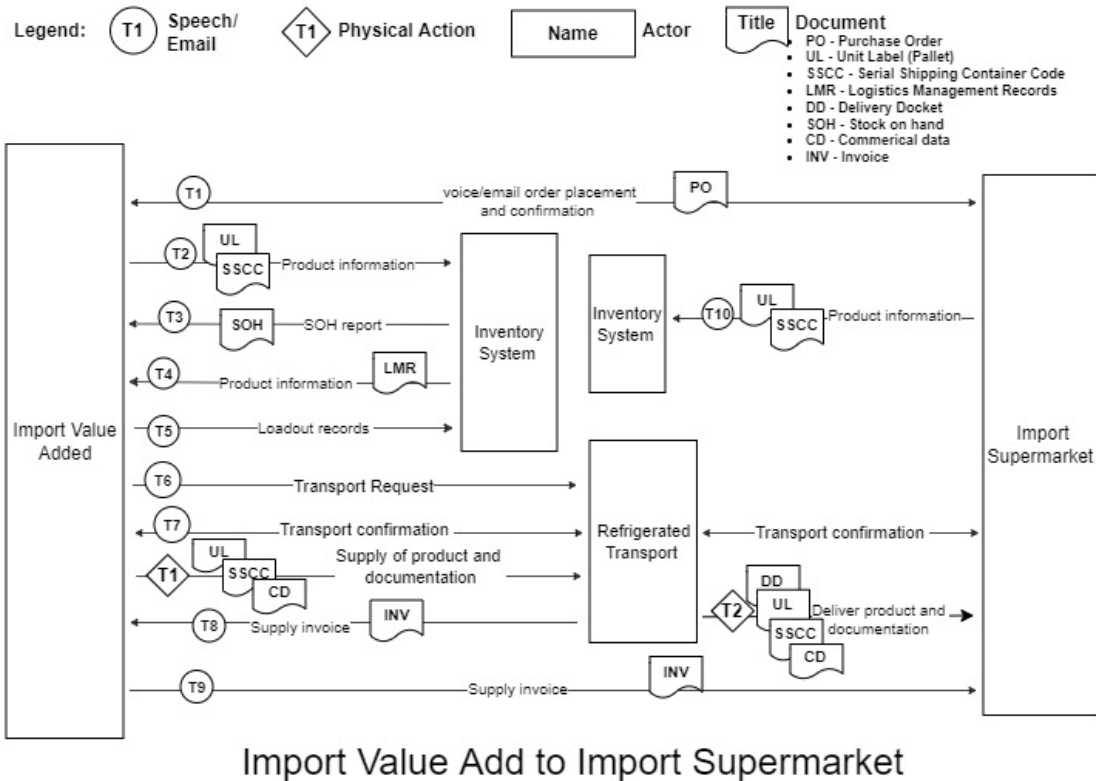

Figure 149. Data or information flows from the import value add to import supermarket in the small stock supply chain.

5.2.6.4.7.5 Import Value Added to Import Butcher

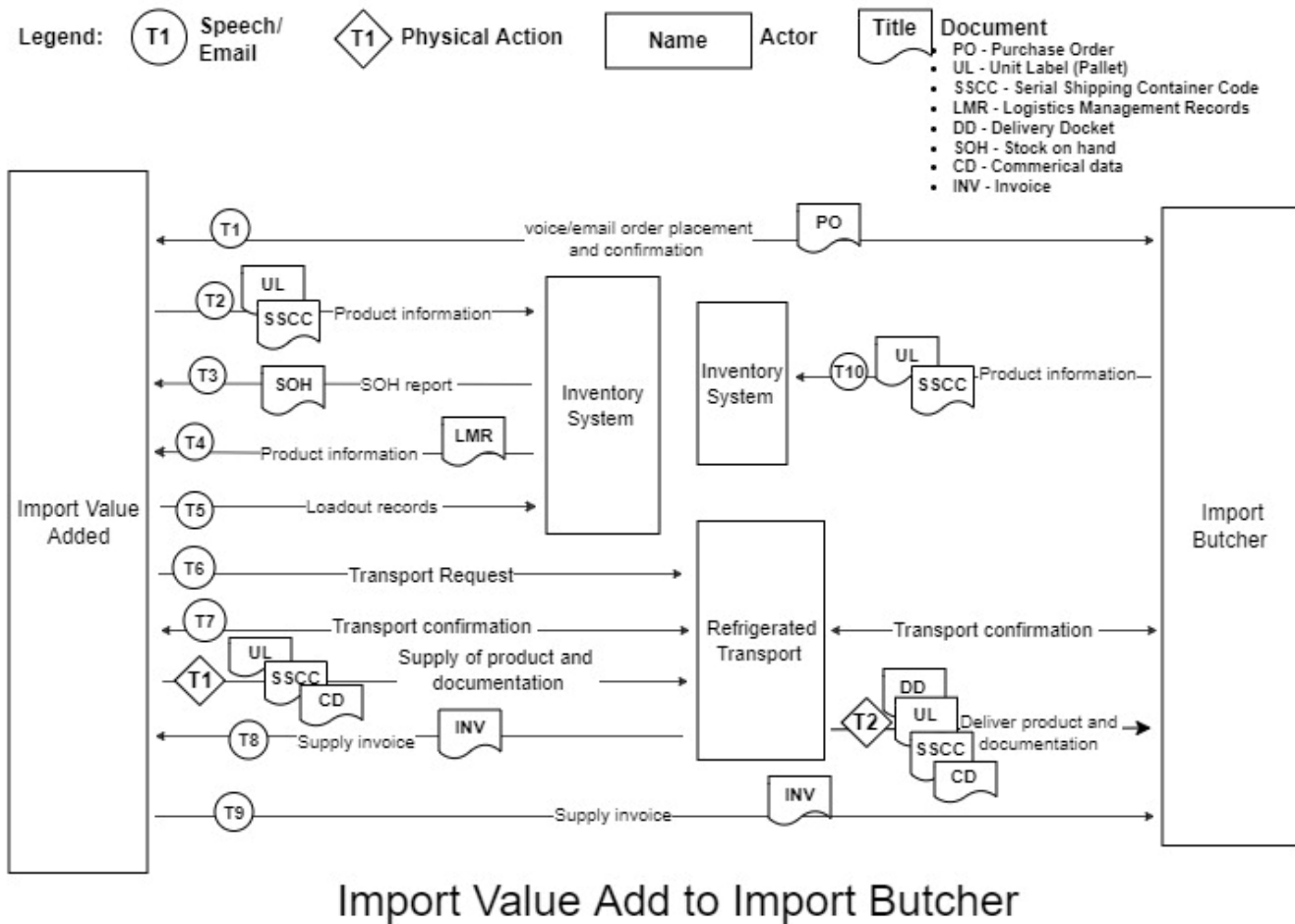

Figure 150. Data or information flows from the import value add to import butcher in the small stock supply chain.

5.2.6.4.7.6 Import Value Added to Import Food Services

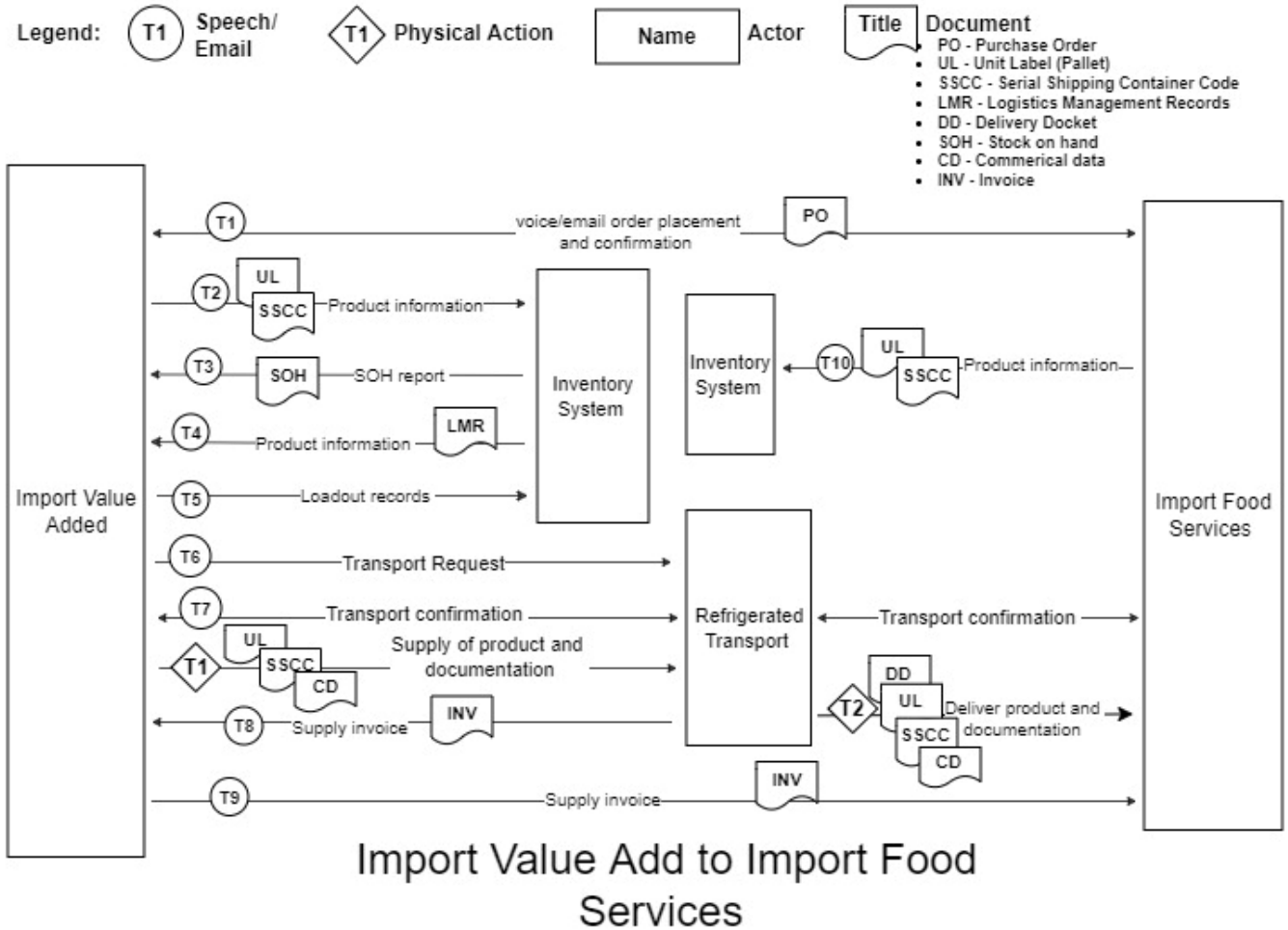

Figure 151. Data or information flows from the import value add to import food services in the small stock supply chain.

5.2.6.5 Import third party cold store

Storing chilled carcasses or carcase products (e.g., cartons) typically provides a stock buffer between production and dispatch of product intended for domestic or export markets. A third-party cold storage system is an establishment, separate from a processing establishment, which performs activities the same as that for a cold storage facility integrated into a processing plant. However, product from multiple suppliers may be stored and/combined for dispatch. A cold storage facility involves refrigerated chambers that can chill or freeze any perishable product for a period of time before dispatch. During this process, the ageing of meat also occurs, progressively increasing tenderness and flavour. Storage rooms must take into account the storage requirements for different products as well as rules for loading, maintenance and hygiene of storage equipment.

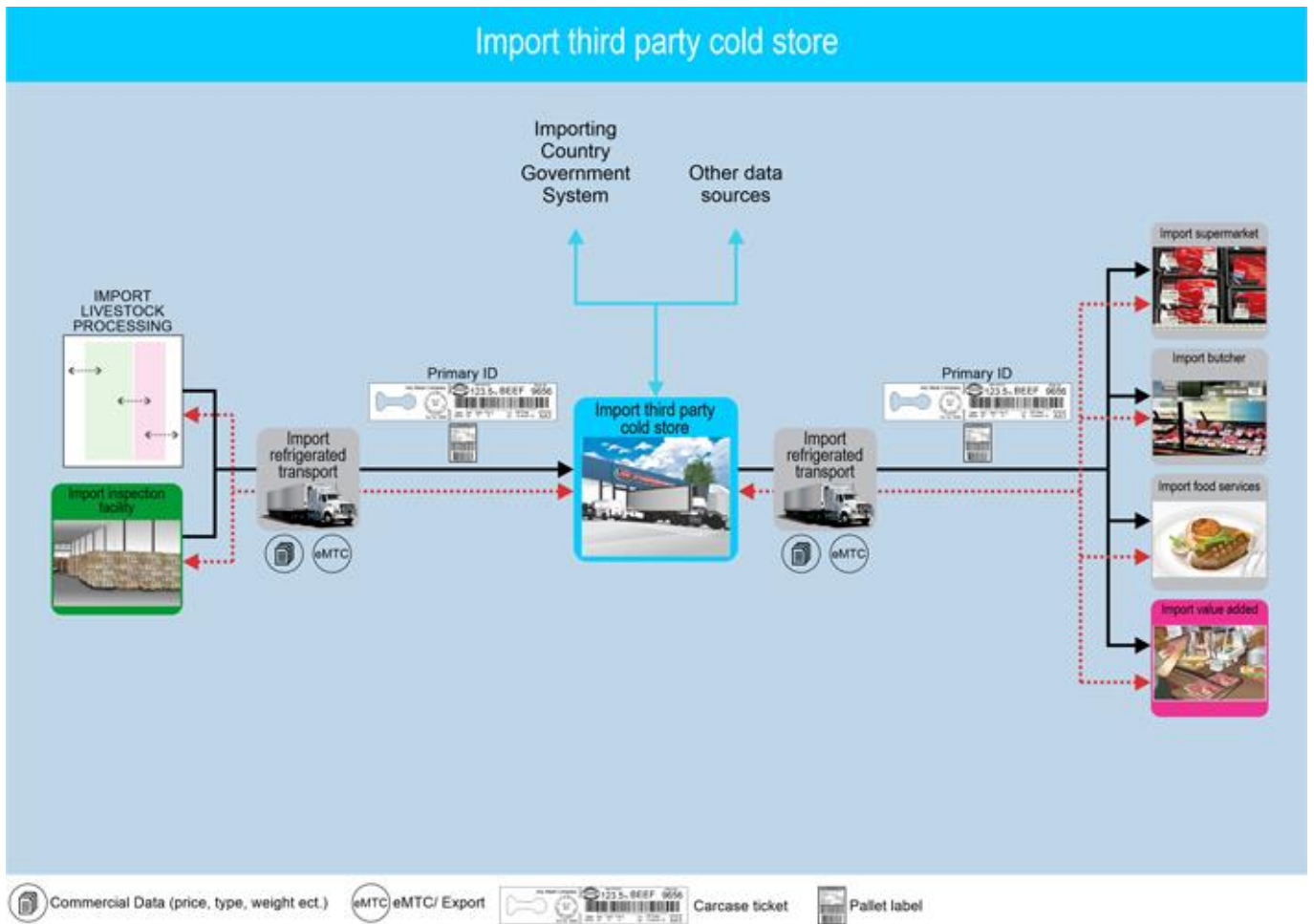

Figure 152. Inputs and outputs of the small stock supply chain import third party cold store sector.

5.2.6.5.1 Physical Inputs including Critical Tracking Events (CTEs)

Cold stores generally offer their clients a range of services involving stock rotation, logistics, maintenance, and systems of identification. Product moved into cold stores ranges from carcasses to pallets of product. These are accompanied by documentation such as Import specific movement documents and Delivery Dockets.

Critical Tracking Events (CTEs) are defined as those events which include the growing, receiving, transforming, creating, and shipping of food products. Such events are critical to the traceability of product throughout the supply chain.

The CTEs associated with inputs to the import third party cold store system include the receipt of:

- Carcase
- Carton
- Pallet
- Container System Unit (meat and meat products).

Table 134. Physical inputs and associated Critical Tracking Event related documents for a small stock import third party cold store system.

Event related to the inputs	Description of the inputs	Critical Tracking Event (CTE) related documents (including electronic)	More details
-----------------------------	---------------------------	--	--------------

Carcase	The body of a slaughtered animal after bleeding. Becomes a dressed carcass when hide/skin, head, feet, and offal are removed.	Carcass Ticket, Delivery Docket/Manifest, Import specific meat/meat product movement forms, Third Party Cold Store production management system, Import Receipt of purchase/Tax Invoice	
Carton	This is a case, crate, or barrel of product.	Carton label, Delivery Docket/Manifest, Import specific meat/meat product movement forms, Third Party Cold Store production management system, Import Receipt of purchase/Tax Invoice	
Pallet	A logistic unit which includes a number of cartons or goods items packed together for transport or storage purposes.	Delivery Docket/Manifest, Import specific meat/meat product movement forms, Third Party Cold Store production management system, Import Receipt of purchase/Tax Invoice, SSCC/Pallet label	
Container System Unit (meat and meat products)	A container designed for use as a unit of cargo handling equipment in the transport of goods by aircraft or ship.	Bill of lading/Air Waybill, Certificate of Analysis (COA), Delivery Docket/Manifest, Import Permit, Import specific meat/meat product movement forms, Imported Food Inspection Advice, Import Receipt of purchase/Tax Invoice, Third Party Cold Store production management system	

5.2.6.5.2 Information Inputs including Key Data Elements (KDEs)

Key Data Elements (KDEs) are defined as those elements which are key in identifying and tracing the Critical Tracking Event (CTE). Key Data Elements found on CTE documentation accompanying the movement of product into cold stores ranges from carcass body numbers (found on the Carcass Ticket) to establishment numbers, official marks, and seal serial numbers.

Table 135. Information inputs, Key Data Elements and Critical Tracking Event related documentation for a small stock import third party cold store system.

Attributes (including KDEs)	Description of the Attributes (including KDEs)	Is a KDE	Critical Tracking Event (CTE) related documents (including electronic)	More details
Analysis Date	This is the date on which a product sample was analysed.	Yes	Certificate of Analysis (COA), Imported Food Inspection Advice, Third Party Cold Store production management system	
Batch number	This is a unique number which identifies products sharing certain production characteristics and is used for traceability purposes.	Yes	Carcass Ticket, Third Party Cold Store production management system	
Bill of lading/Air Waybill document number	A unique document number issued for traceability purposes.	Yes	Bill of lading/Air Waybill, Certificate of Analysis (COA), Third Party Cold Store production management system	
Body number	This is a number assigned to each carcass by the processor for identification purposes.	Yes	Carcass Ticket, Third Party Cold Store production management system	
Certificate of Analysis number	A unique certificate number issued for traceability purposes.	Yes	Certificate of Analysis (COA), Imported Food Inspection	

			Advice, Third Party Cold Store production management system	
COA test lot identifier	This is a unique identifier allocated to all cartons, pallets, and shipping containers for which an analysis sample represents.	Yes	Certificate of Analysis (COA), Imported Food Inspection Advice, Third Party Cold Store production management system	
Company/product code	This is an in-house code for the identification of the product in the unit.	Yes	Bill of lading/Air Waybill, Carton label, Certificate of Analysis (COA), Import Receipt of purchase/Tax Invoice, Imported Food Inspection Advice, SSCC/Pallet label, Third Party Cold Store production management system	
Consignment Serial Shipping Container Code (SSCC)	Encoded in the GS1 barcode, this is a unique number which identifies the individual logistic unit i.e., shipment/message that is assigned by the establishment constructing the unit. The SSCC remains the same for the life of the logistic unit.	Yes	Bill of lading/Air Waybill, Import specific meat/meat product movement forms, Imported Food Inspection Advice, SSCC/Pallet label, Third Party Cold Store production management system	For more information visit the GS1 website.
Contract number	This is a unique number allocated to the contract by the seller.	Yes	Delivery Docket/Manifest, Third Party Cold Store production management system	
Count of Trade Items	Usually encoded in the GS1 barcode, this is the number of trade items e.g., cartons in the logistic unit.	Yes	Bill of lading/Air Waybill, Delivery Docket/Manifest, Imported Food Inspection Advice, SSCC/Pallet label, Third Party Cold Store production management system	For more information visit the GS1 website.
Date	This is the date of signing or of which a record entry or transaction was made.	Yes	Bill of lading/Air Waybill, Certificate of Analysis (COA), Delivery Docket/Manifest, Import Receipt of purchase/Tax Invoice, Import specific meat/meat product movement forms, Third Party Cold Store production management system	
Delivery Docket/Manifest number	This is a unique number allocated to the docket for identification purposes.	Yes	Delivery Docket/Manifest, Third Party Cold Store production management system	
Food Control Certificate entry number	This is a number assigned to the entry of a shipment of goods imported by the same owner at the	Yes	Imported Food Inspection Advice, Third Party Cold Store production management system	

	same time which can be described by one import entry.			
From Establishment number	A number issued by Federal and State Authorities to identify the originating site from which meat or meat products were distributed to domestic or export markets. For transfer certificates, the Establishment numbers for both the dispatching and receiving establishments are recorded.	Yes	Carcase Ticket, Carton label, Certificate of Analysis (COA), Delivery Docket/Manifest, SSCC/Pallet label, Third Party Cold Store production management system	
From property identifier	The identification of the property (may be a PIC) from/to where the livestock or product were consigned.	Yes	Import specific meat/meat product movement forms, Third Party Cold Store production management system	
Global Trade Item Number (GTIN)	Encoded in the GS1 barcode, the GTIN is a globally unique 14-digit number used to identify trade items, products, or services.	Yes	Carcase Ticket, Carton label, SSCC/Pallet label, Third Party Cold Store production management system	For more information visit the GS1 website.
GTIN of Contained Trade Items	Encoded in the GS1 barcode, the GTIN of the contained trade items is a globally unique 14-digit number used to identify trade items, products, or services in the logistic unit.	Yes	SSCC/Pallet label, Third Party Cold Store production management system	For more information visit the GS1 website.
Import Permit Number	A unique permit number is allocated for the import consignment following submission of correct and validated documentation approved by the importing country.	Yes	Import Permit	
Imported Food Inspection Advice certificate number	A unique certificate number issued for traceability purposes.	Yes	Imported Food Inspection Advice, Third Party Cold Store production management system	
Lot number	A lot is a number assigned by the processor to each group of livestock consigned to slaughter and is usually vendor specific.	Yes	Carcase Ticket, Third Party Cold Store production management system	
Meat/meat product movement form number	A unique certificate number issued for traceability purposes.	Yes	Import specific meat/meat product movement forms, Third Party Cold Store production management system	
Movement date	The date on which livestock or other products (e.g., feed or meat products) were transported between PICs/establishments.	Yes	Bill of lading/Air Waybill, Certificate of Analysis (COA), Delivery Docket/Manifest, Import specific meat/meat product movement forms, Third Party Cold Store production management system	

Net Weight (Kilograms)	Usually encoded in the GS1 barcode, the Net Weight is a variable measure of the trade item e.g., carton, pallet or shipment recorded in kilograms.	Yes	Bill of lading/Air Waybill, Carcase Ticket, Carton label, SSCC/Pallet label, Third Party Cold Store production management system	For more information visit the GS1 website.
Official mark	Any stamp, seal, label, or mark that is declared by the regulations to be an official mark. An official mark signifies that the product has been inspected by and approved as safe for human consumption by an Authorised Officer.	Yes	Carcase Ticket, Carton label, SSCC/Pallet label, Third Party Cold Store production management system	
Order date	This is the date on which the purchase order or contract was raised by the buyer.	Yes	Delivery Docket/Manifest, Third Party Cold Store production management system	
Packaging Date	Encoded in the GS1 barcode, the Packaging Date is the date on which the item was packaged and is recorded in the format year, month, day (YYMMDD).	Yes	Carton label, Certificate of Analysis (COA), SSCC/Pallet label, Third Party Cold Store production management system	For more information visit the GS1 website.
Packaging Date Range	This includes the oldest and newest packaging dates for the logistic unit.	Yes	SSCC/Pallet label, Third Party Cold Store production management system	For more information visit the GS1 website.
Pallet Serial Shipping Container Code (SSCC)	Encoded in the GS1 barcode, this is a unique number which identifies the individual logistic unit i.e., pallet that is assigned by the establishment constructing the unit. The SSCC remains the same for the life of the logistic unit.	Yes	Import specific meat/meat product movement forms, SSCC/Pallet label, Third Party Cold Store production management system	For more information visit the GS1 website.
Production Date (YYMMDD)	Encoded in the GS1 barcode, this is the 'kill' or slaughter' date of the product and is recorded in the format year, month, day (YYMMDD).	Yes	Carcase Ticket, Certificate of Analysis (COA), Import specific meat/meat product movement forms, Third Party Cold Store production management system	For more information visit the GS1 website.
Recipient Business Number	This is a unique registration number, used to identify businesses.	Yes	Import Receipt of purchase/Tax Invoice, Third Party Cold Store production management system	
Seal Serial Number	This is a unique serial number printed on any tamper-evident seal issued by the Department.	Yes	Bill of lading/Air Waybill, Third Party Cold Store production management system	
Seller/Supplier Business Number	This is a unique registration number, used to identify businesses.	Yes	Import Receipt of purchase/Tax Invoice, Third Party Cold Store production management system	
Serial Number	Encoded in the GS1 barcode, this is a code, numeric or alphanumeric,	Yes	Carcase Ticket, Carton label, Third Party Cold Store	

	assigned to an individual instance of an item for its lifetime.		production management system	
Shipping Mark	Also known as a port mark, this is a code comprising of three letters representing the foreign establishment number and the last nine digits of the consignment SSCC.	Yes	Bill of lading/Air Waybill, Certificate of Analysis (COA), Delivery Docket/Manifest, SSCC/Pallet label, Third Party Cold Store production management system	
To property identifier	The identification of the property (may be a PIC) from/to where the livestock or product were consigned.	Yes	Import specific meat/meat product movement forms, Third Party Cold Store production management system	
Trade description	This is a collective set of words that says what the product is and may include information such as species, net weight of product, name and address of establishments, category ciphers, market endorsements, MSA eating quality etc.	Yes	Carcase Ticket, Carton label, Delivery Docket/Manifest, SSCC/Pallet label, Third Party Cold Store production management system	
Transport registration number	The registration number of the vehicle in which the animals or product were transported. For shipments of product this will be a shipping container number.	Yes	Bill of lading/Air Waybill, Delivery Docket/Manifest, Import specific meat/meat product movement forms, Third Party Cold Store production management system	

5.2.6.5.3 Physical Outputs including Critical Tracking Events (CTEs)

Product exiting cold stores which is transferred along the supply chain ranges from carcasses to pallets of meat/meat products. Critical Tracking Event Documentation required here may include labels such as the Carcase Ticket or Pallet Label, Import specific meat/meat product movement forms and Delivery Dockets.

Critical Tracking Events (CTEs) are defined as those events which include the growing, receiving, transforming, creating and shipping of food products. Such events are critical to the traceability of product throughout the supply chain.

The CTEs associated with the outputs of the import third party cold store system include the movement of:

- Carcase
- Carton
- Pallet

off the property, premises, or supply chain sector.

Table 136. Physical outputs and associated Critical Tracking Event related documents for a small stock import third party cold store system.

Event related to the inputs	Description of the inputs	Critical Tracking Event (CTE) related documents (including electronic)	More details

Carcase	The body of a slaughtered animal after bleeding. Becomes a dressed carcass when hide/skin, head, feet, and offal are removed.	Carcass Ticket, Delivery Docket/Manifest, Import specific meat/meat product movement forms, Third Party Cold Store production management system, Import Receipt of purchase/Tax Invoice	
Carton	This is a case, crate, or barrel of product.	Carton label, Delivery Docket/Manifest, Import specific meat/meat product movement forms, Third Party Cold Store production management system, Import Receipt of purchase/Tax Invoice	
Pallet	A logistic unit which includes a number of cartons or goods items packed together for transport or storage purposes.	Delivery Docket/Manifest, Import specific meat/meat product movement forms, Third Party Cold Store production management system, Import Receipt of purchase/Tax Invoice, SSCC/Pallet label	

5.2.6.5.4 Information Outputs including Key Data Elements (KDEs)

Key Data Elements (KDEs) are defined as those elements which are key in identifying and tracing the Critical Tracking Event (CTE). Key Data Elements from cold store CTE related documentation will be stored in the production management system. Such information may include, but not be limited to, GS1 barcode application identifiers, movement dates, product net weight, seal serial numbers and import specific meat/meat product movement certificate numbers.

Table 137. Information outputs, Key Data Elements and Critical Tracking Event related documentation for a small stock import third party cold store system.

Attributes (including KDEs)	Description of the Attributes (including KDEs)	Is a KDE	Critical Tracking Event (CTE) related documents (including electronic)	More details
Batch number	This is a unique number which identifies products sharing certain production characteristics and is used for traceability purposes.	Yes	Carcass Ticket, Third Party Cold Store production management system, Carcass Ticket, Third Party Cold Store production management system	
Company/product code	This is an in-house code for the identification of the product in the unit.	Yes	Carton label, Import Receipt of purchase/Tax Invoice, SSCC/Pallet label, Third Party Cold Store production management system	
Consignment Serial Shipping Container Code (SSCC)	Encoded in the GS1 barcode, this is a unique number which identifies the individual logistic unit i.e., shipment/message that is assigned by the establishment constructing the unit. The SSCC remains the same for the life of the logistic unit.	Yes	Import specific meat/meat product movement forms, SSCC/Pallet label, Third Party Cold Store production management system	
Contract number	This is a unique number allocated to the contract by the seller.	Yes	Delivery Docket/Manifest, Third Party Cold Store production management system	

Count of Trade Items	Usually encoded in the GS1 barcode, this is the number of trade items e.g., cartons in the logistic unit.	Yes	Delivery Docket/Manifest, SSCC/Pallet label, Third Party Cold Store production management system	
Date	This is the date of signing or of which a record entry or transaction was made.	Yes	Delivery Docket/Manifest, Import Receipt of purchase/Tax Invoice, Import specific meat/meat product movement forms, Third Party Cold Store production management system	
Delivery Docket/Manifest number	This is a unique number allocated to the docket for identification purposes.	Yes	Delivery Docket/Manifest, Third Party Cold Store production management system	
From Establishment number	A number issued by Federal and State Authorities to identify the originating site from which meat or meat products were distributed to domestic or export markets. For transfer certificates, the Establishment numbers for both the dispatching and receiving establishments are recorded.	Yes	Carcase Ticket, Carton label, Delivery Docket/Manifest, SSCC/Pallet label, Third Party Cold Store production management system	
From property identifier	The identification of the property (may be a PIC) from/to where the livestock or product were consigned.	Yes	Import specific meat/meat product movement forms, Third Party Cold Store production management system	
Global Trade Item Number (GTIN)	Encoded in the GS1 barcode, the GTIN is a globally unique 14-digit number used to identify trade items, products, or services.	Yes	Carcase Ticket, Carton label, SSCC/Pallet label, Third Party Cold Store production management system	For more information visit the GS1 website.
GTIN of Contained Trade Items	Encoded in the GS1 barcode, the GTIN of the contained trade items is a globally unique 14-digit number used to identify trade items, products, or services in the logistic unit.	Yes	SSCC/Pallet label, Third Party Cold Store production management system	For more information visit the GS1 website.
Lot number	A lot is a number assigned by the processor to each group of livestock consigned to slaughter and is usually vendor specific.	Yes	Carcase Ticket, Third Party Cold Store production management system	
Meat/meat product movement form number	A unique certificate number issued for traceability purposes.	Yes	Import specific meat/meat product movement forms, Third Party Cold Store production management system	
Movement date	The date on which livestock or other products (e.g., feed or meat products)	Yes	Delivery Docket/Manifest, Import specific	

	were transported between PICs/establishments.		meat/meat product movement forms, Third Party Cold Store production management system	
Net Weight (Kilograms)	Usually encoded in the GS1 barcode, the Net Weight is a variable measure of the trade item e.g., carton, pallet or shipment recorded in kilograms.	Yes	Carcase Ticket, Carton label, SSCC/Pallet label, Third Party Cold Store production management system	For more information visit the GS1 website.
Official mark	Any stamp, seal, label, or mark that is declared by the regulations to be an official mark. An official mark signifies that the product has been inspected by and approved as safe for human consumption by an Authorised Officer.	Yes	Carcase Ticket, Carton label, SSCC/Pallet label, Third Party Cold Store production management system	
Order date	This is the date on which the purchase order or contract was raised by the buyer.	Yes	Delivery Docket/Manifest, Third Party Cold Store production management system	
Packaging Date	Encoded in the GS1 barcode, the Packaging Date is the date on which the item was packaged and is recorded in the format year, month, day (YYMMDD).	Yes	Carton label, SSCC/Pallet label, Third Party Cold Store production management system	For more information visit the GS1 website.
Packaging Date Range	This includes the oldest and newest packaging dates for the logistic unit.	Yes	SSCC/Pallet label, Third Party Cold Store production management system	For more information visit the GS1 website.
Pallet Serial Shipping Container Code (SSCC)	Encoded in the GS1 barcode, this is a unique number which identifies the individual logistic unit i.e., pallet that is assigned by the establishment constructing the unit. The SSCC remains the same for the life of the logistic unit.	Yes	Import specific meat/meat product movement forms, SSCC/Pallet label, Third Party Cold Store production management system	For more information visit the GS1 website.
Production Date (YYMMDD)	Encoded in the GS1 barcode, this is the 'kill' or slaughter' date of the product and is recorded in the format year, month, day (YYMMDD).	Yes	Carcase Ticket, Import specific meat/meat product movement forms, Third Party Cold Store production management system	For more information visit the GS1 website.
Recipient Business Number	This is a unique registration number, used to identify businesses.	Yes	Import Receipt of purchase/Tax Invoice, Third Party Cold Store production management system	
Seller/Supplier Business Number	This is a unique registration number, used to identify businesses.	Yes	Import Receipt of purchase/Tax Invoice, Third Party Cold Store production management system	
Serial Number	Encoded in the GS1 barcode, this is a code, numeric or alphanumeric, assigned to an	Yes	Carcase Ticket, Carton label, Third Party Cold	For more information visit the

	individual instance of an item for its lifetime.		Store production management system	GS1 website.
Shipping Mark	Also known as a port mark, this is a code comprising of three letters representing the foreign establishment number and the last nine digits of the consignment SSCC.	Yes	Delivery Docket/Manifest, SSCC/Pallet label, Third Party Cold Store production management system	
To property identifier	The identification of the property (may be a PIC) from/to where the livestock or product were consigned.	Yes	Import specific meat/meat product movement forms, Third Party Cold Store production management system	
Trade description	This is a collective set of words that says what the product is and may include information such as species, net weight of product, name and address of establishments, category ciphers, market endorsements, MSA eating quality etc.	Yes	Carcase Ticket, Carton label, Delivery Docket/Manifest, SSCC/Pallet label, Third Party Cold Store production management system	
Transport registration number	The registration number of the vehicle in which the animals or product were transported. For shipments of product this will be a shipping container number.	Yes	Delivery Docket/Manifest, Import specific meat/meat product movement forms, Third Party Cold Store production management system	

5.2.6.5.5 Regulatory and Industry Programs

- Importing Country Government System
- Other data sources

5.2.6.5.6 Supply Chain Node Traceability

The traceability of third-party cold store product back to the live animal (depending on the NLIS tag type), or consignment group and property of origin is dependent on the form in which product enters the storage premises. This may include whole carcass, cartoned or palletised form.

Traceability of whole carcasses back to the live animal, or consignment group is possible and can be done by the processing establishment where the animal was slaughtered as importers of livestock are required to demonstrate that animals remain traceable throughout the supply chain up to the point of slaughter. Here, carcasses are issued a carcass ticket which correlates to the live animal identifier and contains key information, including GS1 meat industry barcode, body number, processing establishment number and production date or 'kill date'. Thus, whole carcasses (identified with a unique serialised carcass ticket) within a processing facility, chiller, cold store, or other premises (e.g., retail) are fully traceable back to the individual live animal, or consignment group and property of origin.

Traceability for cartoned and palletised product is limited to the carcasses that have entered the boning room for the production run of cartons that are created. For example, 200 carcasses individually identified with unique carcass tickets enter the boning room for a specific boning run. These carcass tickets are linked to the specific boning run. From these 200 cartons of primal cuts and 200 cartons of trim and other highly mixed products are

created. While all cartons are identified with unique serialised carton labels, including a GS1 meat industry barcode, linked to the boning run (and may be packaged into pallets containing unique serialised pallet labels including a GS1 SSCC barcode), it is not readily possible to identify which carcasses are in which cartons as the cartons will contain meat products from different carcasses. If the carcasses were sourced from several different properties, the resulting carton can only be traced to a number of possible carcasses and source properties. In logistical systems such as transport and cold stores, cartons are typically processed by pallets with only the pallet label being scanned. Therefore, traceability through logistics is often at the pallet level.

5.2.6.5.7 Data flow diagrams

Table 138. Data flow diagrams for the inputs and outputs of a small stock import third party cold store system.

Direction	Description
Input	Cold Store (Carcase) to Third party cold store
Input	Cold Store (Carton) to Third party cold store
Output	Third party cold store to Supermarket
Output	Third party cold store to Butcher
Output	Third party cold store to Food Service
Output	Third party cold store to Value Added
Output	Third party cold store to Export

5.2.6.5.7.1 Cold Store (Carcase) to Third party cold store

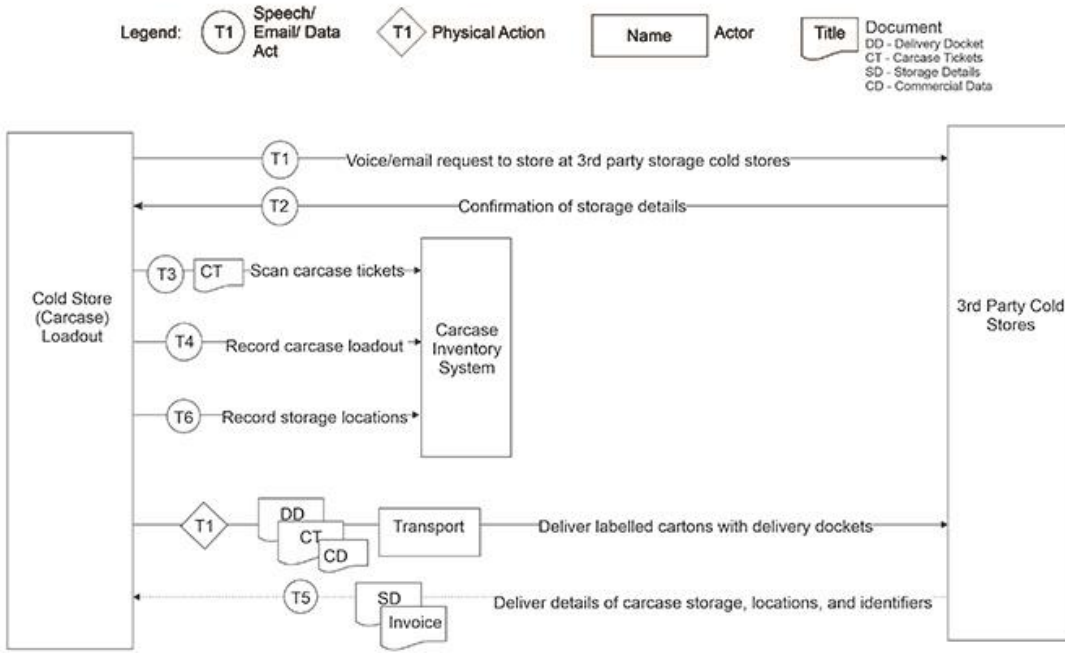

Carcass Loadout to 3rd Party Storage Cold Stores

Figure 153. Data or information flows from the import carcass loadout to import third party cold store systems in the small stock supply chain.

5.2.6.5.7.2 Cold Store (Carton) to Third party cold store

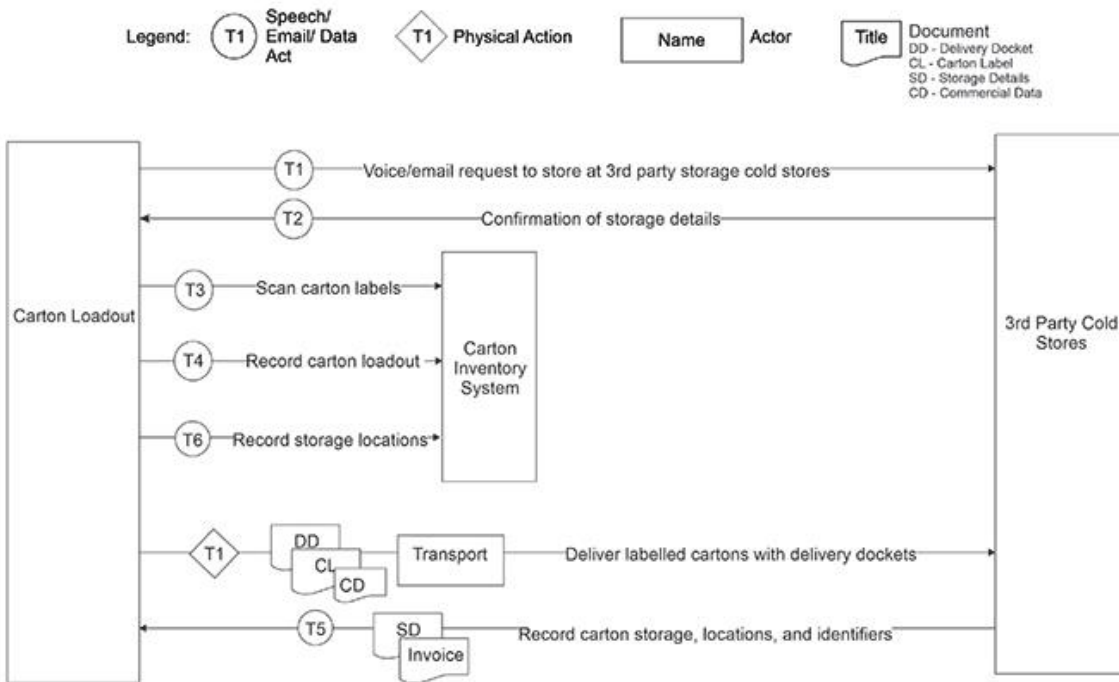

Carton Loadout to 3rd Party Storage Cold Stores

Figure 154. Data or information flows from the import carton loadout to import third party cold store systems in the small stock supply chain.

5.2.6.5.7.3 Third party cold store to Supermarket

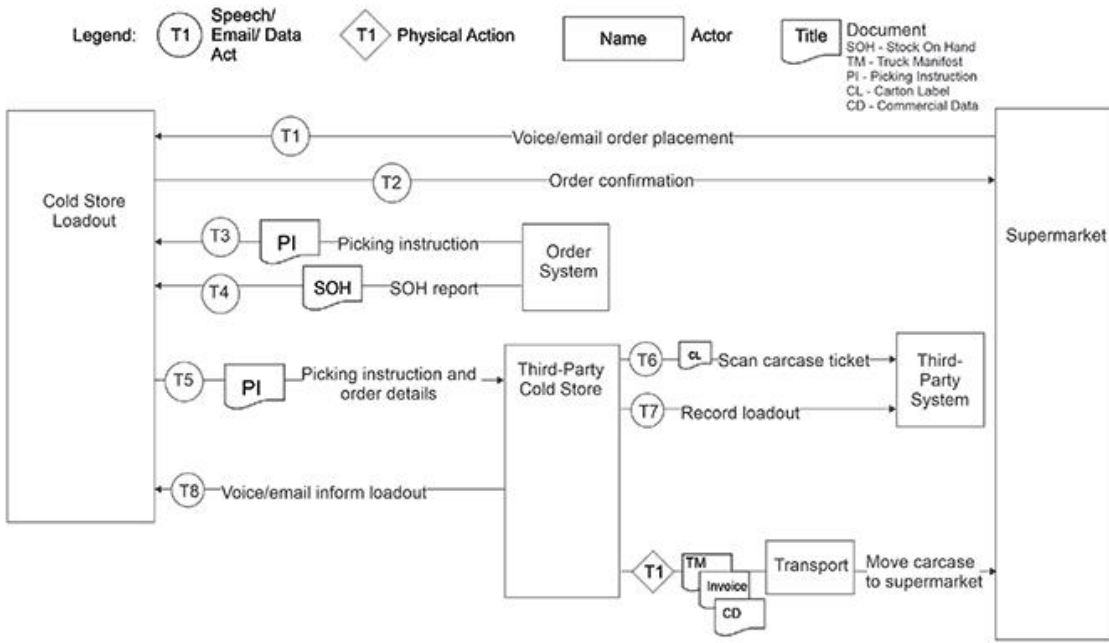

Third-Party Cold Store to Supermarket

Figure 155. Data or information flows from the import third party cold store to import supermarket systems in the small stock supply chain.

5.2.6.5.7.4 Third party cold store to Butcher

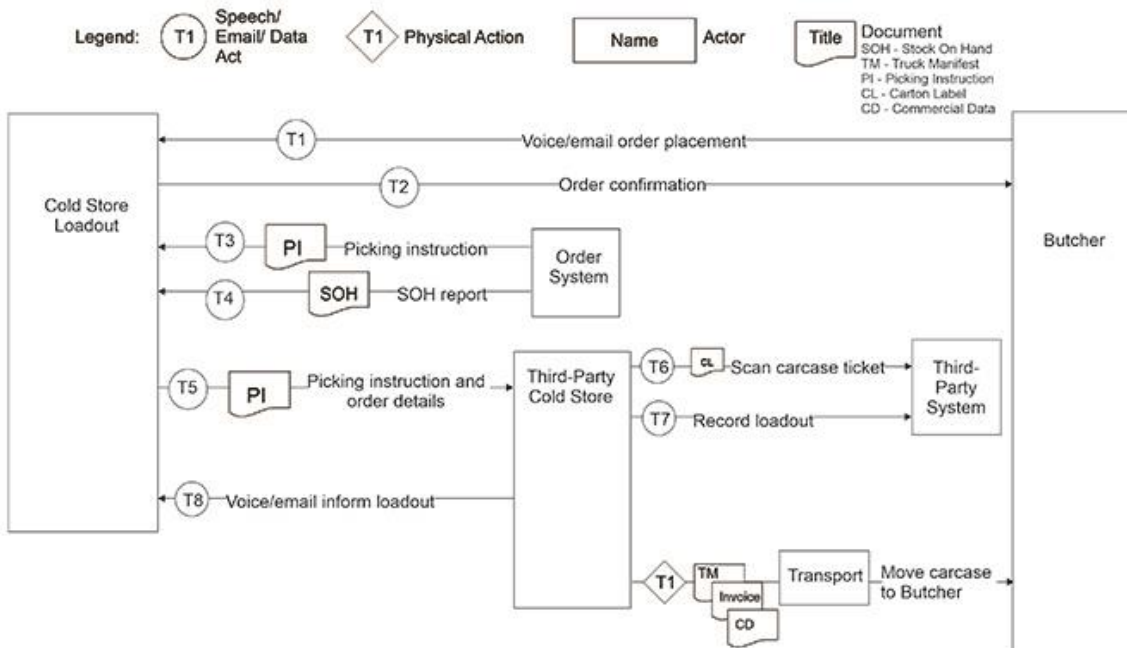

Third-Party Cold Store to Butcher

Figure 156. Data or information flows from the import third party cold store to import butcher systems in the small stock supply chain.

5.2.6.5.7.5 Third party cold store to Food Service

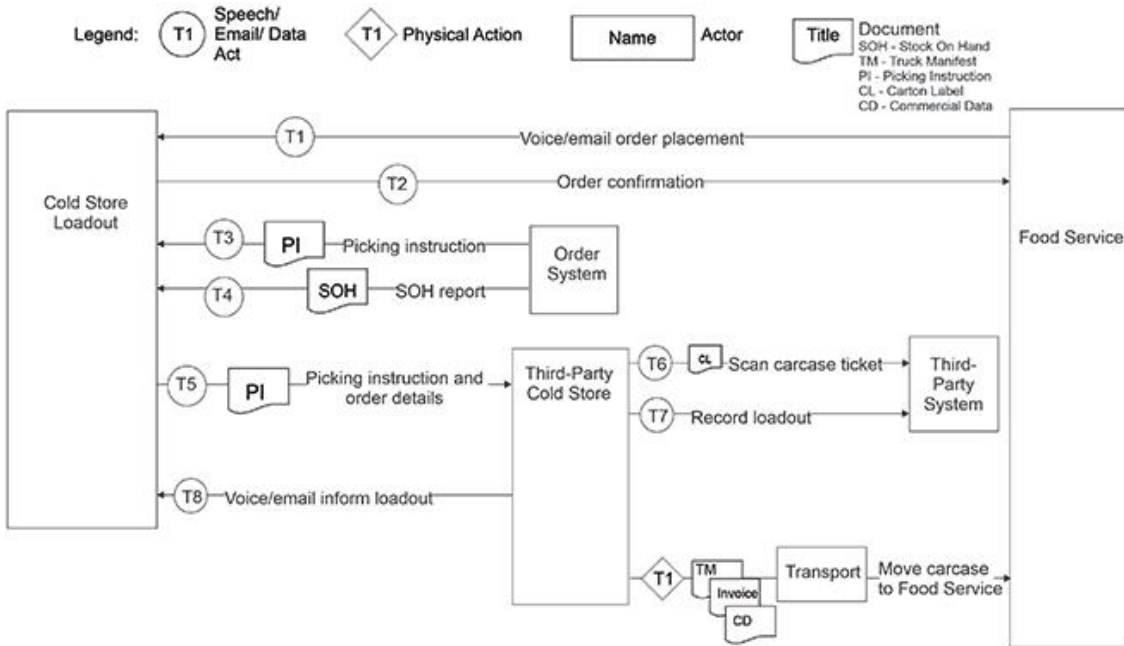

Third-Party Cold Store to Food Service

Figure 157. Data or information flows from the import third party cold store to import food service systems in the small stock supply chain.

5.2.6.5.7.6 Third party cold store to Value Added

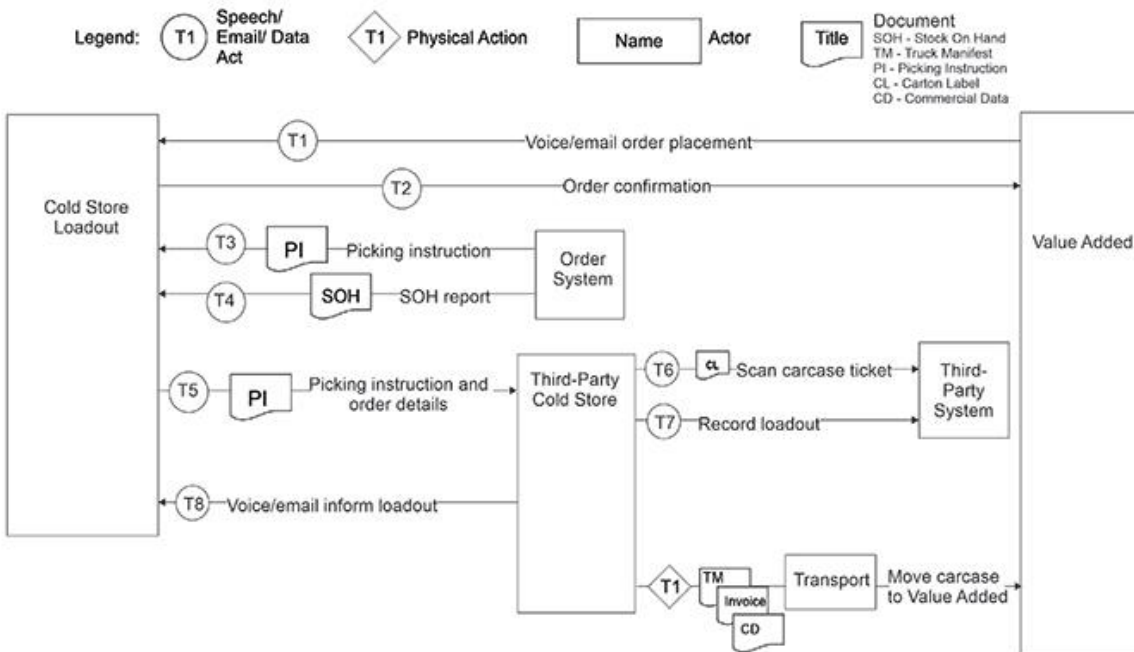

Third-Party Cold Store to Value Added

Figure 158. Data or information flows from the import third party cold store to import value added systems in the small stock supply chain.

5.2.6.5.7.7 Third party cold store to Export

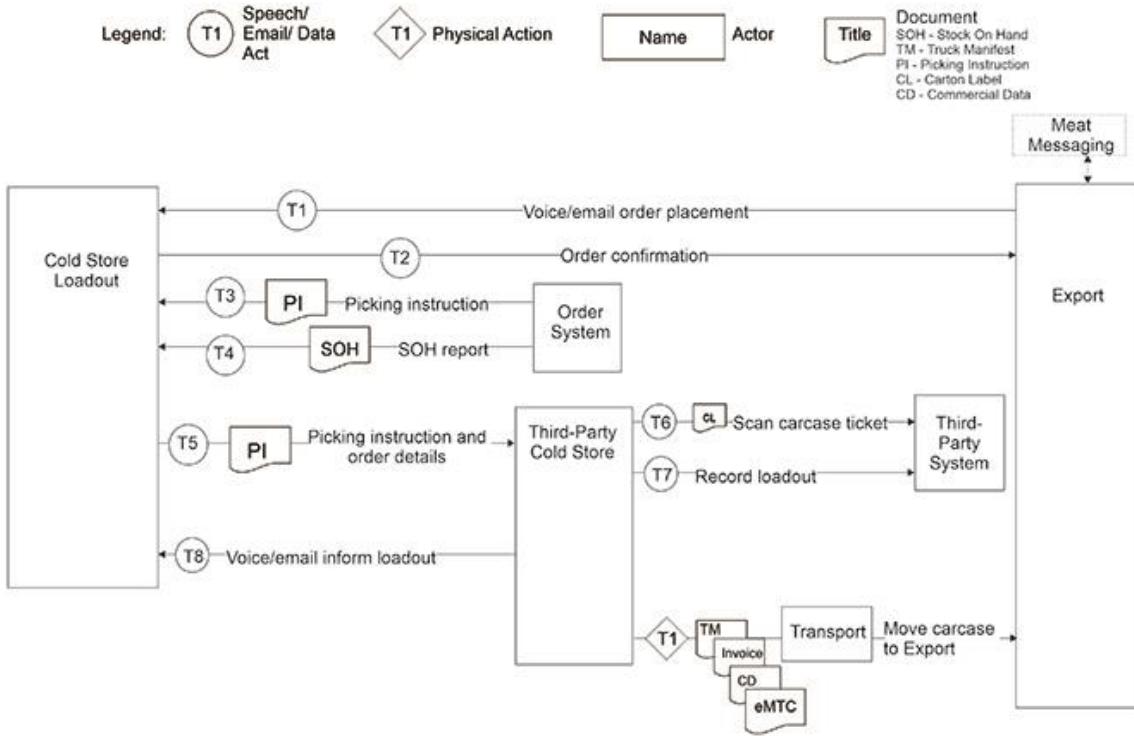

Third-Party Cold Store to Export

Figure 159. Data or information flows from the import third party cold store to export systems in the small stock supply chain.

5.2.6.6 Import supermarket

Supermarkets are product distribution centres whereby retail-ready product is sourced from suppliers (processors or third-party cold store) or product is prepared on-site from carcass or cartoned product. These distribution centres may be chain or retail stores which assemble these goods, sourced from individual suppliers, for purchase by consumers. Product may be pre-packaged and branded by the supplier or by the supermarket and each item identified with a retail-ready product label.

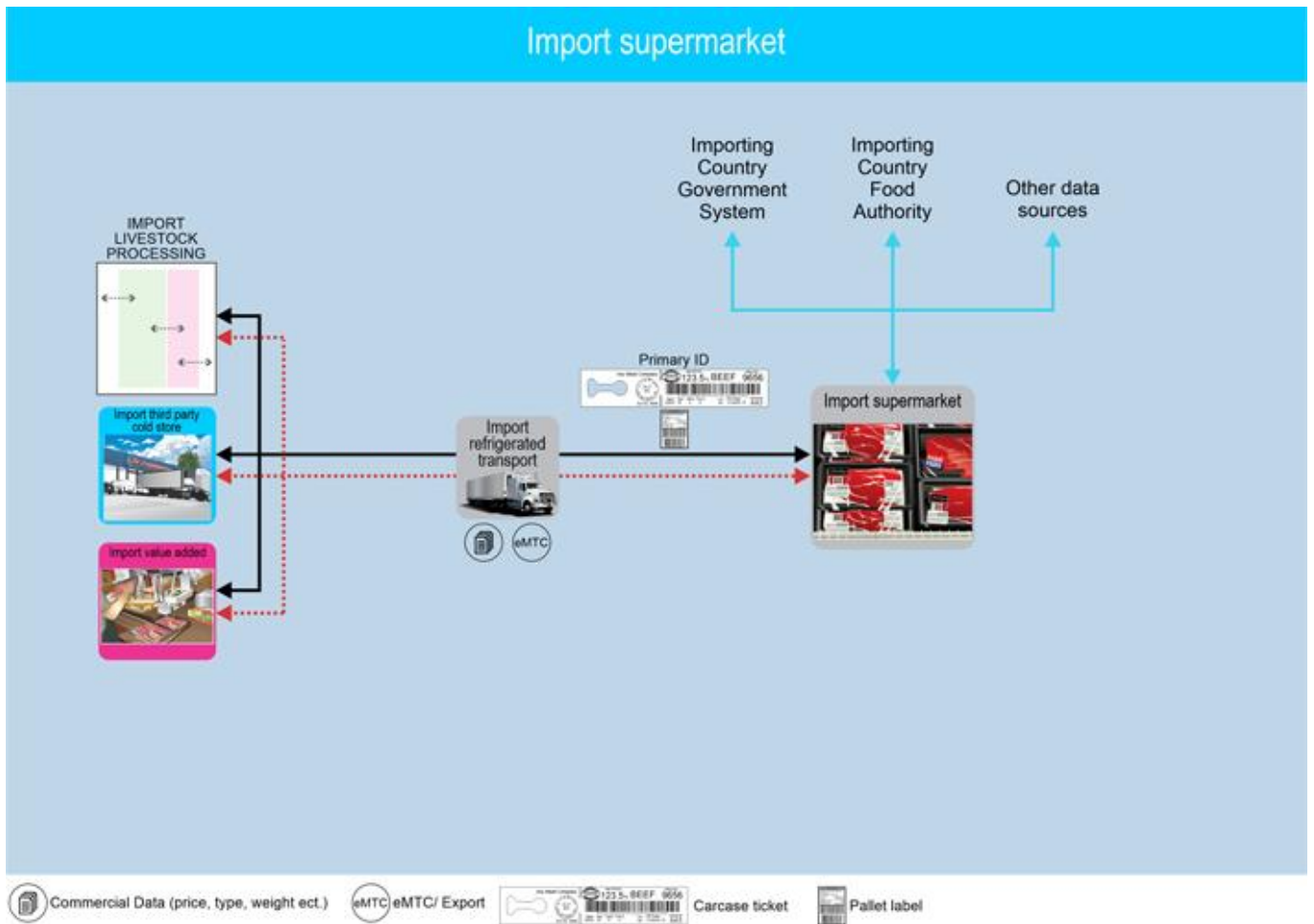

Figure 160. Inputs and outputs of the small stock supply chain import supermarket sector.

5.2.6.6.1 Physical Inputs including Critical Tracking Events (CTEs)

The inputs for import supermarkets include meat product in carcase form for onsite butchering as well as pre-packaged product from processors and value adding facilities. Critical Tracking Event related documentation for the movement of product into supermarkets includes standard movement documentation such as the Delivery Docket/Manifest, import specific meat/meat product movement forms, carton, and pallet labels.

Critical Tracking Events (CTEs) are defined as those events which include the growing, receiving, transforming, creating and shipping of food products. Such events are critical to the traceability of product throughout the supply chain.

The CTEs associated with inputs to the import supermarket system include the receipt of:

- Carcase
- Carton
- Pallet.

Table 139. Physical inputs and associated Critical Tracking Event related documents for a small stock import supermarket system.

Event related	Description of the inputs	Critical Tracking Event (CTE) related documents (including electronic)	More details
---------------	---------------------------	--	--------------

to the inputs			
Carcase	The body of a slaughtered animal after bleeding. Becomes a dressed carcass when hide/skin, head, feet, and offal are removed.	Carcass Ticket, Delivery Docket/Manifest, Import specific meat/meat product movement forms, Retail production management system, Import Receipt of purchase/Tax Invoice	
Carton	This is a case, crate, or barrel of product.	Carton label, Delivery Docket/Manifest, Import specific meat/meat product movement forms, Retail production management system, Import Receipt of purchase/Tax Invoice	
Pallet	A logistic unit which includes a number of cartons or goods items packed together for transport or storage purposes.	Delivery Docket/Manifest, Import specific meat/meat product movement forms, Retail production management system, Import Receipt of purchase/Tax Invoice, SSCC/Pallet label	

5.2.6.6.2 Information Inputs including Key Data Elements (KDEs)

Key Data Elements (KDEs) are defined as those elements which are key in identifying and tracing the Critical Tracking Event (CTE). Information inputs or KDEs for the movement of meat product into the supermarket can be found on Critical Tracking Event related documentation and may be stored in the retailer's production management system.

Table 140. Information inputs, Key Data Elements and Critical Tracking Event related documentation for a small stock import supermarket system.

Attributes (including KDEs)	Description of the Attributes (including KDEs)	Is a KDE	Critical Tracking Event (CTE) related documents (including electronic)	More details
Batch number	This is a unique number which identifies products sharing certain production characteristics and is used for traceability purposes.	Yes	Carcass Ticket, Retail production management system, Carcass Ticket, Retail production management system	
Company/product code	This is an in-house code for the identification of the product in the unit.	Yes	Carton label, Import Receipt of purchase/Tax Invoice, Retail production management system, SSCC/Pallet label	
Consignment Serial Shipping Container Code (SSCC)	Encoded in the GS1 barcode, this is a unique number which identifies the individual logistic unit i.e., shipment/message that is assigned by the establishment constructing the unit. The SSCC remains the same for the life of the logistic unit.	Yes	Import specific meat/meat product movement forms, Retail production management system, SSCC/Pallet label	For more information visit the GS1 website.
Contract number	This is a unique number allocated to the contract by the seller.	Yes	Delivery Docket/Manifest, Retail production management system	

Count of Trade Items	Usually encoded in the GS1 barcode, this is the number of trade items e.g., cartons in the logistic unit.	Yes	Delivery Docket/Manifest, Retail production management system, SSCC/Pallet label	For more information visit the GS1 website.
Date	This is the date of signing or of which a record entry or transaction was made.	Yes	Delivery Docket/Manifest, Import Receipt of purchase/Tax Invoice, Import specific meat/meat product movement forms, Retail production management system	
Delivery Docket/Manifest number	This is a unique number allocated to the docket for identification purposes.	Yes	Delivery Docket/Manifest, Retail production management system	
From Establishment number	A number issued by Federal and State Authorities to identify the originating site from which meat or meat products were distributed to domestic or export markets. For transfer certificates, the Establishment numbers for both the dispatching and receiving establishments are recorded.	Yes	Carcase Ticket, Carton label, Delivery Docket/Manifest, Retail production management system, SSCC/Pallet label	
From property identifier	The identification of the property (may be a PIC) from/to where the livestock or product were consigned.	Yes	Import specific meat/meat product movement forms, Retail production management system	
Global Trade Item Number (GTIN)	Encoded in the GS1 barcode, the GTIN is a globally unique 14-digit number used to identify trade items, products, or services.	Yes	Carcase Ticket, Carton label, Retail production management system, SSCC/Pallet label	For more information visit the GS1 website.
GTIN of Contained Trade Items	Encoded in the GS1 barcode, the GTIN of the contained trade items is a globally unique 14-digit number used to identify trade items, products, or services in the logistic unit.	Yes	Retail production management system, SSCC/Pallet label	For more information visit the GS1 website.
Lot number	A lot is a number assigned by the processor to each group of livestock consigned to slaughter and is usually vendor specific.	Yes	Carcase Ticket, Retail production management system	
Meat/meat product movement form number	A unique certificate number issued for traceability purposes.	Yes	Import specific meat/meat product movement forms, Retail production management system	
Movement date	The date on which livestock or other products (e.g., feed or meat products) were transported between PICs/establishments.	Yes	Delivery Docket/Manifest, Import specific meat/meat product movement forms, Retail	

			production management system	
Net Weight (Kilograms)	Usually encoded in the GS1 barcode, the Net Weight is a variable measure of the trade item e.g., carton, pallet or shipment recorded in kilograms.	Yes	Carcase Ticket, Carton label, Retail production management system, SSCC/Pallet label	For more information visit the GS1 website.
Official mark	Any stamp, seal, label, or mark that is declared by the regulations to be an official mark. An official mark signifies that the product has been inspected by and approved as safe for human consumption by an Authorised Officer.	Yes	Carcase Ticket, Carton label, Retail production management system, SSCC/Pallet label	
Order date	This is the date on which the purchase order or contract was raised by the buyer.	Yes	Delivery Docket/Manifest, Retail production management system	
Packaging Date	Encoded in the GS1 barcode, the Packaging Date is the date on which the item was packaged and is recorded in the format year, month, day (YYMMDD).	Yes	Carton label, Retail production management system, SSCC/Pallet label	For more information visit the GS1 website.
Packaging Date Range	This includes the oldest and newest packaging dates for the logistic unit.	Yes	Retail production management system, SSCC/Pallet label	For more information visit the GS1 website.
Pallet Serial Shipping Container Code (SSCC)	Encoded in the GS1 barcode, this is a unique number which identifies the individual logistic unit i.e., pallet that is assigned by the establishment constructing the unit. The SSCC remains the same for the life of the logistic unit.	Yes	Import specific meat/meat product movement forms, Retail production management system, SSCC/Pallet label	For more information visit the GS1 website.
Production Date (YYMMDD)	Encoded in the GS1 barcode, this is the 'kill' or slaughter' date of the product and is recorded in the format year, month, day (YYMMDD).	Yes	Carcase Ticket, Import specific meat/meat product movement forms, Retail production management system	For more information visit the GS1 website.
Recipient Business Number	This is a unique registration number, used to identify businesses.	Yes	Import Receipt of purchase/Tax Invoice, Retail production management system	
Seller/Supplier Business Number	This is a unique registration number, used to identify businesses.	Yes	Import Receipt of purchase/Tax Invoice, Retail production management system	
Serial Number	Encoded in the GS1 barcode, this is a code, numeric or alphanumeric, assigned to an individual instance of an item for its lifetime.	Yes	Carcase Ticket, Carton label, Retail production management system	For more information visit the GS1 website.
Shipping Mark	Also known as a port mark, this is a code comprising of three letters representing the foreign establishment number and the last nine digits of the consignment SSCC.	Yes	Delivery Docket/Manifest, Retail production management system, SSCC/Pallet label	

To property identifier	The identification of the property (may be a PIC) from/to where the livestock or product were consigned.	Yes	Import specific meat/meat product movement forms, Retail production management system	
Trade description	This is a collective set of words that says what the product is and may include information such as species, net weight of product, name and address of establishments, category ciphers, market endorsements, MSA eating quality etc.	Yes	Carcase Ticket, Carton label, Delivery Docket/Manifest, Retail production management system, SSCC/Pallet label	
Transport registration number	The registration number of the vehicle in which the animals or product were transported. For shipments of product this will be a shipping container number.	Yes	Delivery Docket/Manifest, Import specific meat/meat product movement forms, Retail production management system	

5.2.6.6.3 Physical Outputs including Critical Tracking Events (CTEs)

Retail-ready meat products are the outputs of the supermarket system. Being purchased by consumers, CTE documentation includes the product label and receipt of purchase. Product exiting the system may be recorded in the retailer's production management system.

Critical Tracking Events (CTEs) are defined as those events which include the growing, receiving, transforming, creating, and shipping of food products. Such events are critical to the traceability of product throughout the supply chain.

The CTEs associated with the outputs of the import supermarket system include the movement of:

- Retail Ready Product

off the property, premises, or supply chain sector.

Table 141. Physical outputs and associated Critical Tracking Event related documents for a small stock import supermarket system.

Event related to the inputs	Description of the inputs	Critical Tracking Event (CTE) related documents (including electronic)	More details
Retail Ready Product	These are packaged meat products that are ready to be retailed and purchased by consumers.	Import Receipt of purchase/Tax Invoice, Retail product label, Retail production management system	

5.2.6.6.4 Information Outputs including Key Data Elements (KDEs)

Key Data Elements (KDEs) are defined as those elements which are key in identifying and tracing the Critical Tracking Event (CTE). Information outputs from the supermarket system include KDEs which can be drawn from CTE documentation such as the product label and receipt of purchase. This may include purchase date, product code and application identifiers on the GS1 barcode.

Table 142. Information outputs, Key Data Elements and Critical Tracking Event related documentation for a small stock import supermarket system.

Attributes (including KDEs)	Description of the Attributes (including KDEs)	Is a KDE	Critical Tracking Event (CTE) related documents (including electronic)	More details
Company/product code	This is an in-house code for the identification of the product in the unit.	Yes	Import Receipt of purchase/Tax Invoice, Retail production management system	
Date	This is the date of signing or of which a record entry or transaction was made.	Yes	Import Receipt of purchase/Tax Invoice, Retail production management system	
GS1 compliant numbering and barcode	Numbering and barcode compliant to the GS1 standards and as specified by the contract between the seller and the recipient i.e., retailer.	Yes	Retail product label, Retail production management system	For more information visit the GS1 website.
Recipient Business Number	This is a unique registration number, used to identify businesses.	Yes	Import Receipt of purchase/Tax Invoice, Retail production management system	
Seller/Supplier Business Number	This is a unique registration number, used to identify businesses.	Yes	Import Receipt of purchase/Tax Invoice, Retail production management system	

5.2.6.6.5 Regulatory and Industry Programs

- Importing Country Government System
- Importing Country Food Authority
- Other data sources

5.2.6.6.6 Supply Chain Node Traceability

The traceability of retail-ready product back to the to the live animal (depending on the NLIS tag type), or consignment group and property of origin is dependent on the form in which product enters the retail premises. This may include whole carcass, cartoned or palletised form. Further, the level of traceability for each input form is dependent on the packaging processes of the retailer and the traceability requirements of the importing country. For example, whole carcass product may or may not be fully traceable back to the live animal or consignment group. Where this is true, carcasses are broken down into retail cuts on site and may be packaged individually and labelled with a unique, serialised retail label. For this product, traceability back to the live animal or consignment group is possible and can be done by the processing establishment where the animal was slaughtered as importers of livestock are required to demonstrate that animals remain traceable throughout the supply chain up to the point of slaughter. Here, carcasses are issued a carcass ticket which correlates to the live animal identifier and contains key information, including GS1 meat industry barcode, body number, processing establishment number and production date or 'kill date'. Thus, there is the potential to trace whole carcasses entering retail premises back to the individual live animal, or consignment group and property of origin. Where carcass retail cuts are not individually packaged or are derived from palletised or cartoned product, imported retail-ready product may have the same batch traceability limitations as per boning room and value-added

product. Please refer to Boning room and Value Added 'Supply Chain Node Traceability' for more detailed information.

5.2.6.6.7 Data flow diagrams

Table 143. Data flow diagrams for the inputs and outputs of a small stock import supermarket system.

Direction	Description
Input	Import Refrigerated Transport to Import Supermarket
Input	Import Third Party Cold Store to Import Supermarket
Input	Import Value Added to Import Supermarket

5.2.6.6.7.1 Import Refrigerated Transport to Import Supermarket

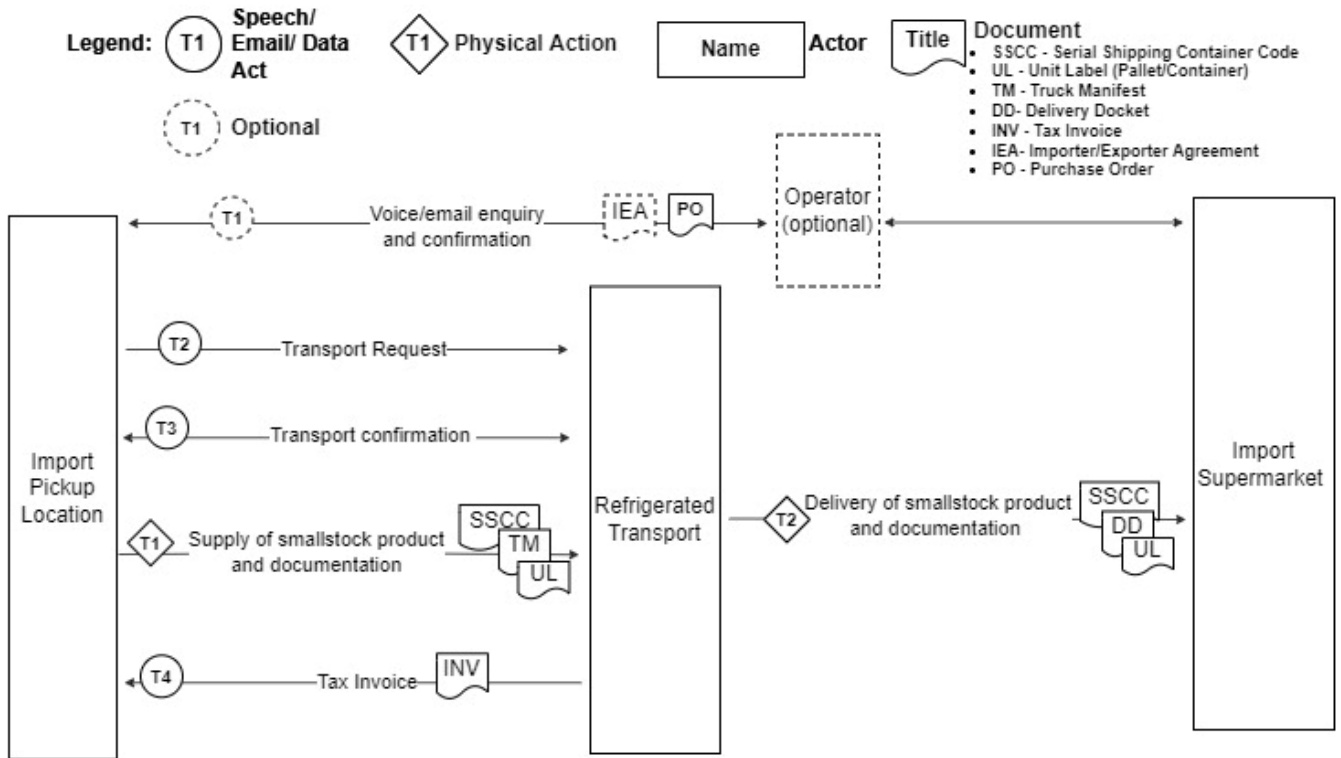

Import Refrigerated Transport

Figure 161. Data or information flow from the import refrigerated transport to import supermarket in the small stock supply chain.

5.2.6.6.7.2 Import Third Party Cold Sore to Import Supermarket

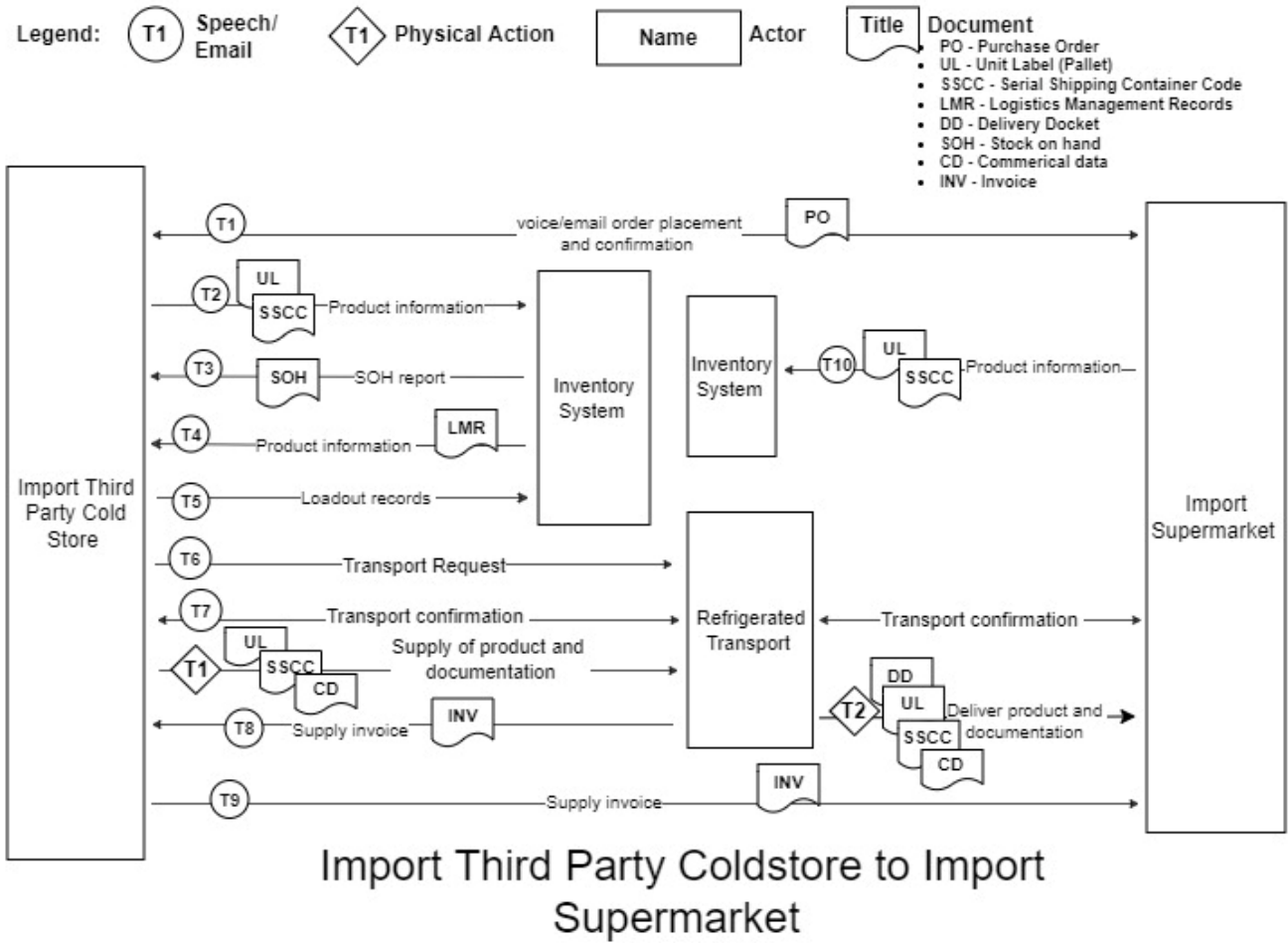

Figure 162. Data or information flow from the import third party cold store to import supermarket in the small stock supply chain.

5.2.6.6.7.3 Import Value Added to Import Supermarket

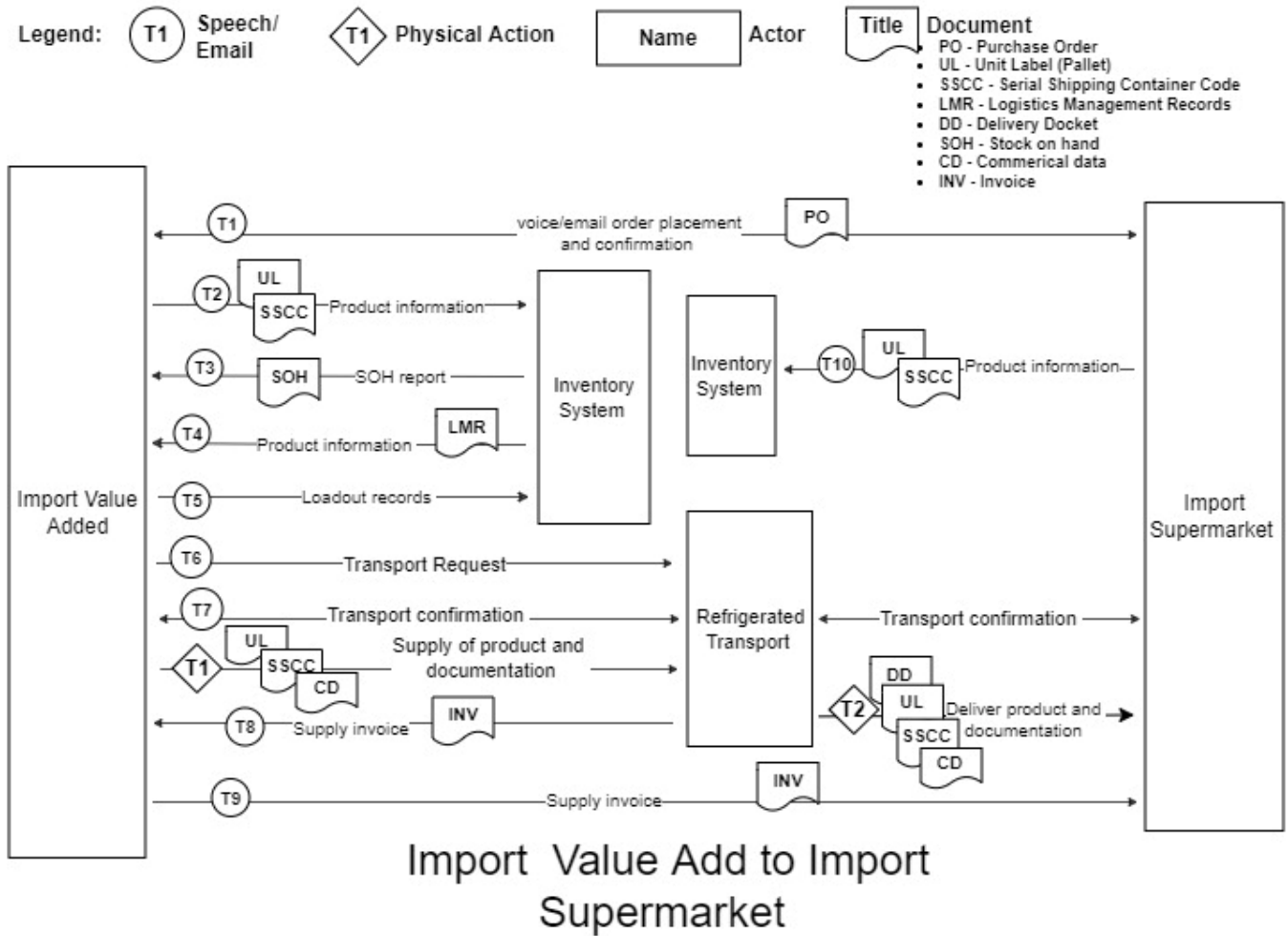

Figure 163. Data or information flows from the import value added to import supermarket in the small stock supply chain.

5.2.6.7 Import butcher

Butchers are meat and meat product retail stores whereby carcass or cartoned product is sourced from processors, third-party cold stores, or value adders, and is prepared for sale to the consumer. This preparation may include value-adding processes whereby a new variety of cuts is provided, the presentation of products is altered, or additional ingredients are added to create new products or enhance the profitability of raw products. For example, cutting primal products into steaks, roasts, or diced products, marinating meat to save time for the consumer, as well as making specialty goods such as mixed sausages and offal.

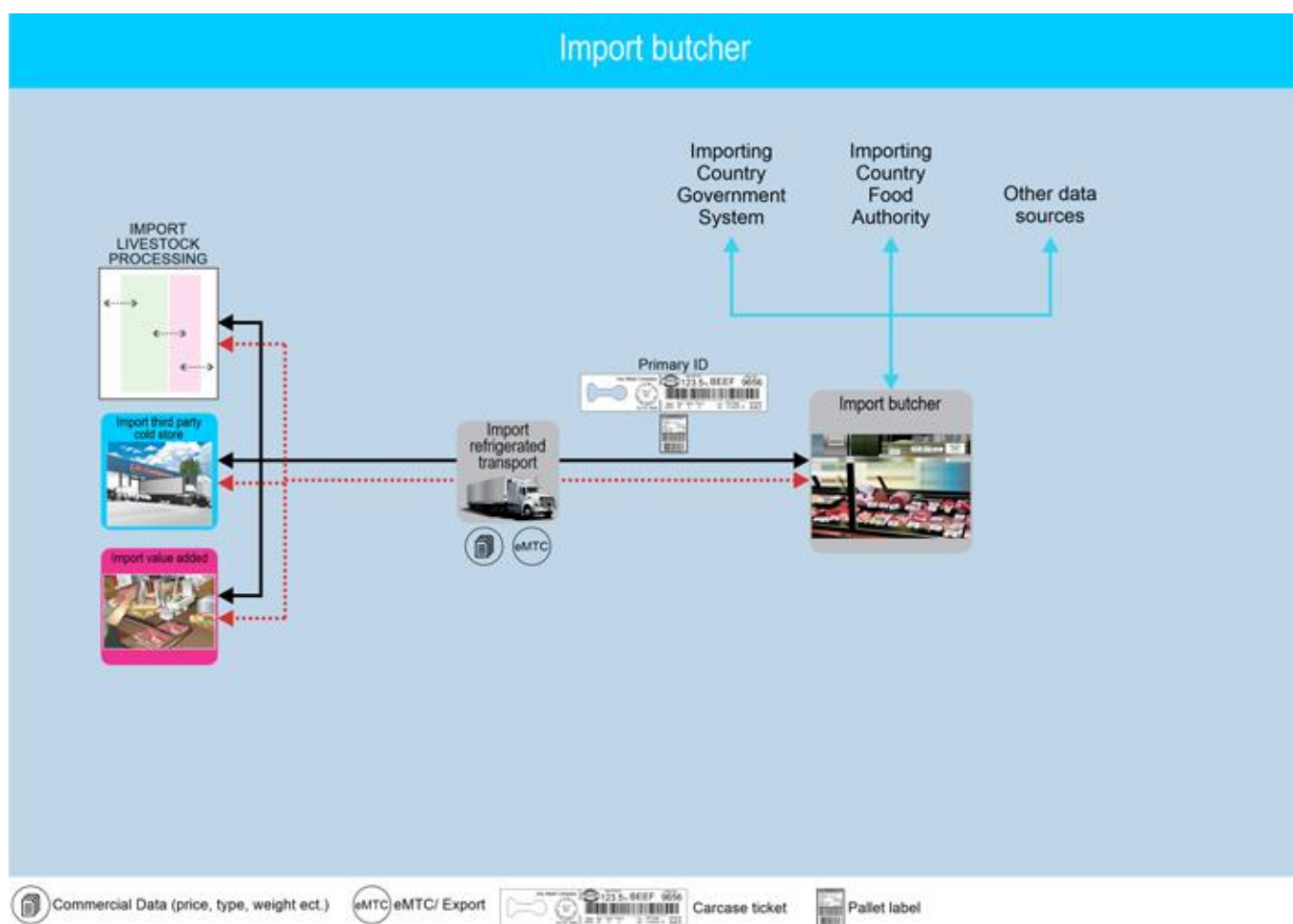

Figure 164. Inputs and outputs of the small stock supply chain import butcher sector.

5.2.6.7.1 Physical Inputs including Critical Tracking Events (CTEs)

The inputs to the butcher system include meat product in carcase form for onsite butchering as well primal or value added product from boning room and value adding facilities. Critical Tracking Event related documentation for the movement of product into butchers includes standard movement documentation such as the Delivery Docket/Manifest, import specific meat/meat product movement forms, carton, and pallet labels.

Critical Tracking Events (CTEs) are defined as those events which include the growing, receiving, transforming, creating and shipping of food products. Such events are critical to the traceability of product throughout the supply chain.

The CTEs associated with inputs to the import butcher system include the receipt of:

- Carcase
- Carton
- Pallet.

Table 144. Physical inputs and associated Critical Tracking Event related documents for a small stock import butcher system.

Event related	Description of the inputs	Critical Tracking Event (CTE) related documents (including electronic)	More details
---------------	---------------------------	--	--------------

to the inputs			
Carcase	The body of a slaughtered animal after bleeding. Becomes a dressed carcass when hide/skin, head, feet, and offal are removed.	Carcass Ticket, Delivery Docket/Manifest, Import specific meat/meat product movement forms, Retail production management system, Import Receipt of purchase/Tax Invoice	
Carton	This is a case, crate, or barrel of product.	Carton label, Delivery Docket/Manifest, Import specific meat/meat product movement forms, Retail production management system, Import Receipt of purchase/Tax Invoice	
Pallet	A logistic unit which includes a number of cartons or goods items packed together for transport or storage purposes.	Delivery Docket/Manifest, Import specific meat/meat product movement forms, Retail production management system, Import Receipt of purchase/Tax Invoice, SSCC/Pallet label	

5.2.6.7.2 Information Inputs including Key Data Elements (KDEs)

Key Data Elements (KDEs) are defined as those elements which are key in identifying and tracing the Critical Tracking Event (CTE). Information inputs or KDEs for the movement of meat product into the butcher system can be found on Critical Tracking Event related documentation and may be stored in the retailer's production management system.

Table 145. Information inputs, Key Data Elements and Critical Tracking Event related documentation for a small stock import butcher system.

Attributes (including KDEs)	Description of the Attributes (including KDEs)	Is a KDE	Critical Tracking Event (CTE) related documents (including electronic)	More details
Batch number	This is a unique number which identifies products sharing certain production characteristics and is used for traceability purposes.	Yes	Carcass Ticket, Retail production management system, Carcass Ticket, Retail production management system	
Company/product code	This is an in-house code for the identification of the product in the unit.	Yes	Carton label, Import Receipt of purchase/Tax Invoice, Retail production management system, SSCC/Pallet label	
Consignment Serial Shipping Container Code (SSCC)	Encoded in the GS1 barcode, this is a unique number which identifies the individual logistic unit i.e., shipment/message that is assigned by the establishment constructing the unit. The SSCC remains the same for the life of the logistic unit.	Yes	Import specific meat/meat product movement forms, Retail production management system, SSCC/Pallet label	For more information visit the GS1 website.
Contract number	This is a unique number allocated to the contract by the seller.	Yes	Delivery Docket/Manifest, Retail production management system	
Count of Trade Items	Usually encoded in the GS1 barcode, this is the number of trade items e.g., cartons in the logistic unit.	Yes	Delivery Docket/Manifest, Retail production management system, SSCC/Pallet label	For more information visit the GS1 website.

Date	This is the date of signing or of which a record entry or transaction was made.	Yes	Delivery Docket/Manifest, Import Receipt of purchase/Tax Invoice, Import specific meat/meat product movement forms, Retail production management system	
Delivery Docket/Manifest number	This is a unique number allocated to the docket for identification purposes.	Yes	Delivery Docket/Manifest, Retail production management system	
From Establishment number	A number issued by Federal and State Authorities to identify the originating site from which meat or meat products were distributed to domestic or export markets. For transfer certificates, the Establishment numbers for both the dispatching and receiving establishments are recorded.	Yes	Carcase Ticket, Carton label, Delivery Docket/Manifest, Retail production management system, SSSC/Pallet label	
From property identifier	The identification of the property (may be a PIC) from/to where the livestock or product were consigned.	Yes	Import specific meat/meat product movement forms, Retail production management system	
Global Trade Item Number (GTIN)	Encoded in the GS1 barcode, the GTIN is a globally unique 14-digit number used to identify trade items, products, or services.	Yes	Carcase Ticket, Carton label, Retail production management system, SSSC/Pallet label	For more information visit the GS1 website.
GTIN of Contained Trade Items	Encoded in the GS1 barcode, the GTIN of the contained trade items is a globally unique 14-digit number used to identify trade items, products, or services in the logistic unit.	Yes	Retail production management system, SSSC/Pallet label	For more information visit the GS1 website.
Lot number	A lot is a number assigned by the processor to each group of livestock consigned to slaughter and is usually vendor specific.	Yes	Carcase Ticket, Retail production management system	
Meat/meat product movement form number	A unique certificate number issued for traceability purposes.	Yes	Import specific meat/meat product movement forms, Retail production management system	
Movement date	The date on which livestock or other products (e.g., feed or meat products) were transported between PICs/establishments.	Yes	Delivery Docket/Manifest, Import specific meat/meat product movement forms, Retail production management system	
Net Weight (Kilograms)	Usually encoded in the GS1 barcode, the Net Weight is a variable measure of the trade item e.g., carton, pallet or shipment recorded in kilograms.	Yes	Carcase Ticket, Carton label, Retail production management system, SSSC/Pallet label	For more information visit the GS1 website.
Official mark	Any stamp, seal, label, or mark that is declared by the regulations to be an official mark. An official mark signifies that the product has been inspected	Yes	Carcase Ticket, Carton label, Retail production management system, SSSC/Pallet label	

	by and approved as safe for human consumption by an Authorised Officer.			
Order date	This is the date on which the purchase order or contract was raised by the buyer.	Yes	Delivery Docket/Manifest, Retail production management system	
Packaging Date	Encoded in the GS1 barcode, the Packaging Date is the date on which the item was packaged and is recorded in the format year, month, day (YYMMDD).	Yes	Carton label, Retail production management system, SSCC/Pallet label	For more information visit the GS1 website.
Packaging Date Range	This includes the oldest and newest packaging dates for the logistic unit.	Yes	Retail production management system, SSCC/Pallet label	For more information visit the GS1 website.
Pallet Serial Shipping Container Code (SSCC)	Encoded in the GS1 barcode, this is a unique number which identifies the individual logistic unit i.e., pallet that is assigned by the establishment constructing the unit. The SSCC remains the same for the life of the logistic unit.	Yes	Import specific meat/meat product movement forms, Retail production management system, SSCC/Pallet label	For more information visit the GS1 website.
Production Date (YYMMDD)	Encoded in the GS1 barcode, this is the 'kill' or slaughter' date of the product and is recorded in the format year, month, day (YYMMDD).	Yes	Carcase Ticket, Import specific meat/meat product movement forms, Retail production management system	For more information visit the GS1 website.
Recipient Business Number	This is a unique registration number, used to identify businesses.	Yes	Import Receipt of purchase/Tax Invoice, Retail production management system	
Seller/Supplier Business Number	This is a unique registration number, used to identify businesses.	Yes	Import Receipt of purchase/Tax Invoice, Retail production management system	
Serial Number	Encoded in the GS1 barcode, this is a code, numeric or alphanumeric, assigned to an individual instance of an item for its lifetime.	Yes	Carcase Ticket, Carton label, Retail production management system	For more information visit the GS1 website.
Shipping Mark	Also known as a port mark, this is a code comprising of three letters representing the foreign establishment number and the last nine digits of the consignment SSCC.	Yes	Delivery Docket/Manifest, Retail production management system, SSCC/Pallet label	
To property identifier	The identification of the property (may be a PIC) from/to where the livestock or product were consigned.	Yes	Import specific meat/meat product movement forms, Retail production management system	
Trade description	This is a collective set of words that says what the product is and may include information such as species, net weight of product, name and address of establishments, category	Yes	Carcase Ticket, Carton label, Delivery Docket/Manifest, Retail production management system, SSCC/Pallet label	

	ciphers, market endorsements, MSA eating quality etc.			
Transport registration number	The registration number of the vehicle in which the animals or product were transported. For shipments of product this will be a shipping container number.	Yes	Delivery Docket/Manifest, Import specific meat/meat product movement forms, Retail production management system	

5.2.6.7.3 Physical Outputs including Critical Tracking Events (CTEs)

Retail-ready meat products are the outputs of the butcher system. Being purchased by consumers, CTE documentation includes the product label and receipt of purchase. Product exiting the system may be recorded in the retailer's production management system.

Critical Tracking Events (CTEs) are defined as those events which include the growing, receiving, transforming, creating and shipping of food products. Such events are critical to the traceability of product throughout the supply chain.

The CTEs associated with the outputs of the import butcher system include the movement of:

- Retail Ready Product

off the property, premises, or supply chain sector.

Table 146. Physical outputs and associated Critical Tracking Event related documents for a small stock import butcher system.

Event related to the inputs	Description of the inputs	Critical Tracking Event (CTE) related documents (including electronic)	More details
Retail Ready Product	These are packaged meat products that are ready to be retailed and purchased by consumers.	Import Receipt of purchase/Tax Invoice, Retail product label, Retail production management system	

5.2.6.7.4 Information Outputs including Key Data Elements (KDEs)

Key Data Elements (KDEs) are defined as those elements which are key in identifying and tracing the Critical Tracking Event (CTE). Information outputs from the butcher system include KDEs which can be drawn from CTE documentation such as the product label and receipt of purchase. This may include purchase date, product code and application identifiers on the GS1 barcode.

Table 147. Information outputs, Key Data Elements and Critical Tracking Event related documentation for a small stock import butcher system.

Attributes (including KDEs)	Description of the Attributes (including KDEs)	Is a KDE	Critical Tracking Event (CTE) related documents (including electronic)	More details
Company/product code	This is an in-house code for the identification of the product in the unit.	Yes	Import Receipt of purchase/Tax Invoice, Retail production management system	

Date	This is the date of signing or of which a record entry or transaction was made.	Yes	Import Receipt of purchase/Tax Invoice, Retail production management system	
GS1 compliant numbering and barcode	Numbering and barcode compliant to the GS1 standards and as specified by the contract between the seller and the recipient i.e., retailer.	Yes	Retail product label, Retail production management system	For more information visit the GS1 website.
Recipient Business Number	This is a unique registration number, used to identify businesses.	Yes	Import Receipt of purchase/Tax Invoice, Retail production management system	
Seller/Supplier Business Number	This is a unique registration number, used to identify businesses.	Yes	Import Receipt of purchase/Tax Invoice, Retail production management system	

5.2.6.7.5 Regulatory and Industry Programs

- Importing Country Government System
- Importing Country Food Authority
- Other data sources

5.2.6.7.6 Supply Chain Node Traceability

The traceability of retail-ready product back to the to the live animal (depending on the NLIS tag type), or consignment group and property of origin is dependent on the form in which product enters the retail premises. This may include whole carcass, cartoned or palletised form. Further, the level of traceability for each input form is dependent on the packaging processes of the retailer and the traceability requirements of the importing country. For example, whole carcass product may or may not be fully traceable back to the live animal or consignment group. Where this is true, carcasses are broken down into retail cuts on site and may be packaged individually and labelled with a unique, serialised retail label. For this product, traceability back to the live animal or consignment group is possible and can be done by the processing establishment where the animal was slaughtered as importers of livestock are required to demonstrate that animals remain traceable throughout the supply chain up to the point of slaughter. Here, carcasses are issued a carcass ticket which correlates to the live animal identifier and contains key information, including GS1 meat industry barcode, body number, processing establishment number and production date or 'kill date'. Thus, there is the potential to trace whole carcasses entering retail premises back to the individual live animal, or consignment group and property of origin. Where carcass retail cuts are not individually packaged or are derived from palletised or cartoned product, imported retail-ready product may have the same batch traceability limitations as per boning room and value-added product. Please refer to Boning room and Value Added 'Supply Chain Node Traceability' for more detailed information.

5.2.6.7.7 Data flow diagrams

Table 148. Data flow diagrams for the inputs and outputs of a small stock import butcher system.

Direction	Description
Input	Import Refrigerated Transport to Import Butcher
Input	Import Third Party Cold Store to Import Butcher
Input	Import Value Added to Import Butcher

5.2.6.7.7.1 Import Refrigerated Transport to Import Butcher

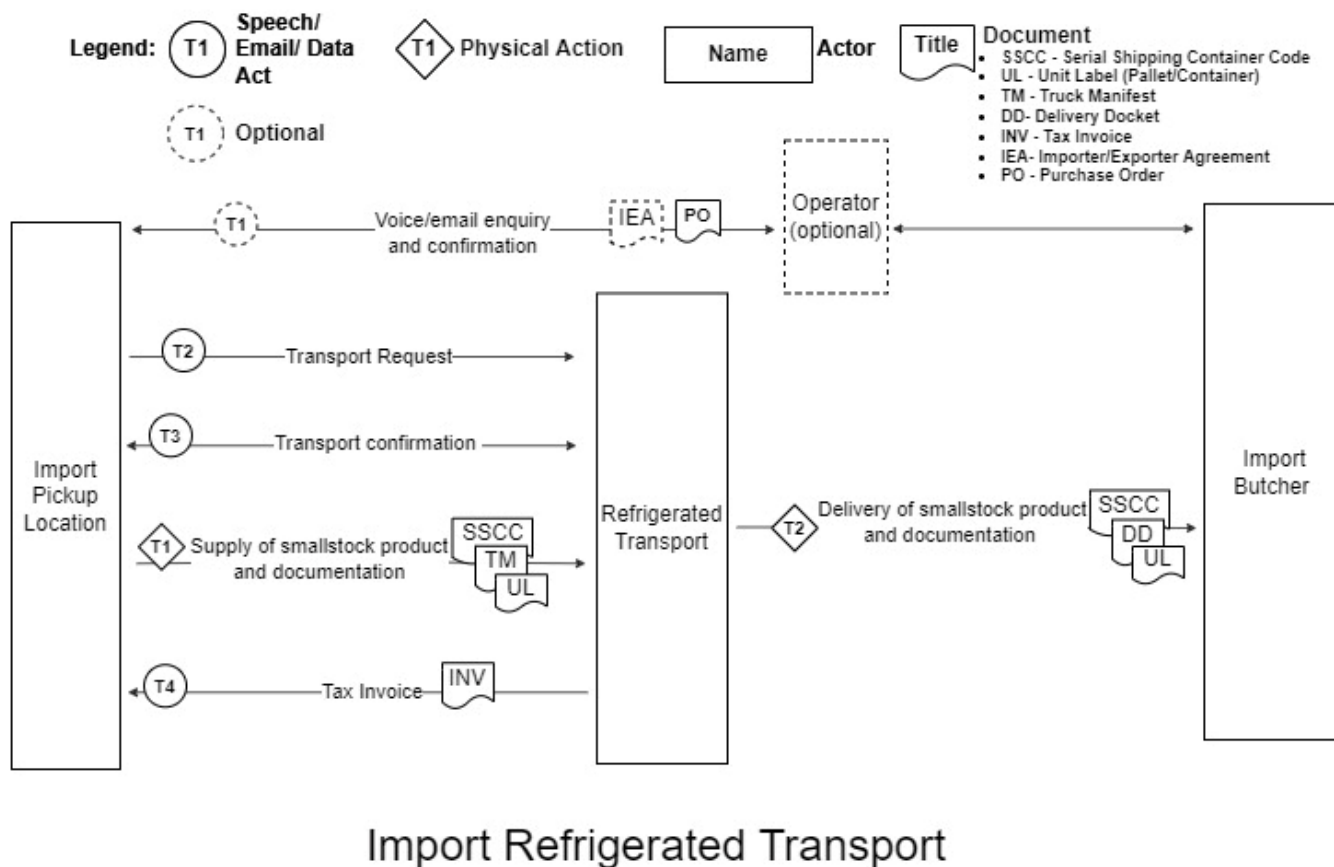

Figure 165. Data or information flows from the import refrigerated transport to import butcher in the small stock supply chain.

5.2.6.7.7.2 Import Third Party Cold Store to Import Butcher

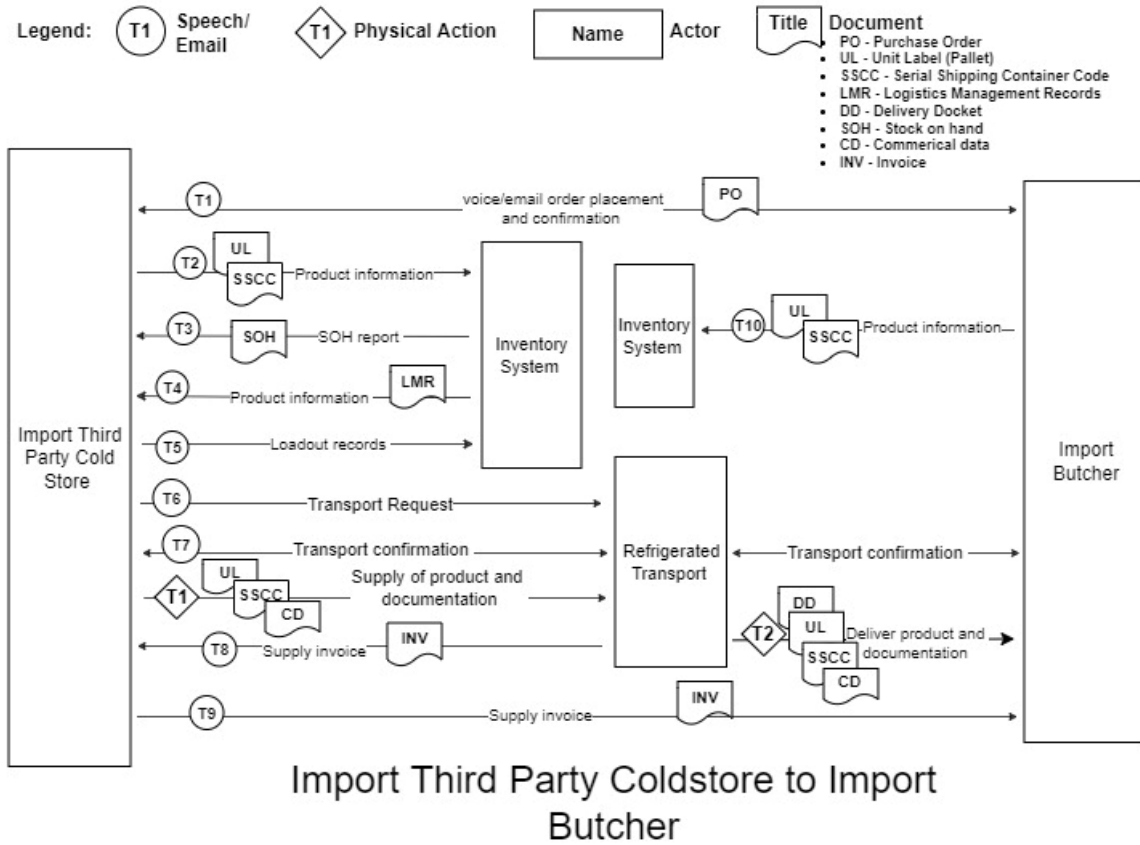

Figure 166. Data or information flow from the import third party cold store to import butcher in the small stock supply chain.

5.2.6.7.7.3 Import Value Added to Import Butcher

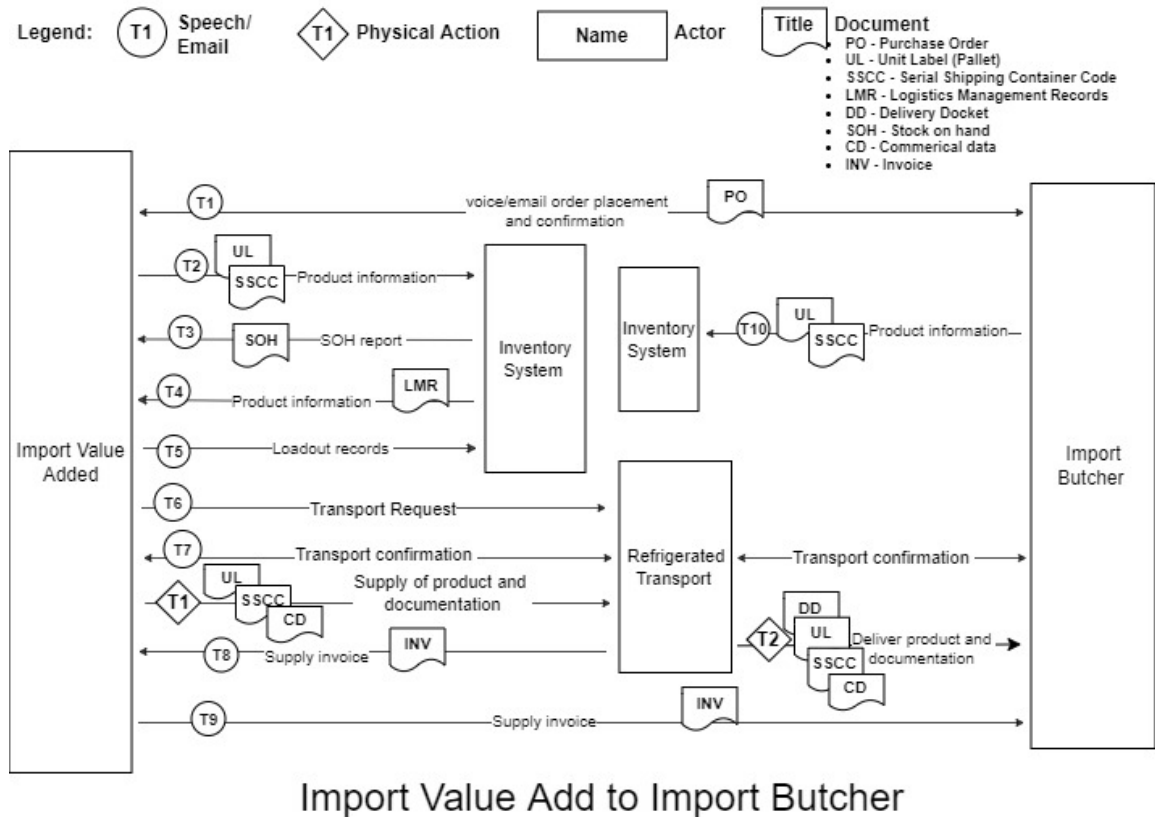

Figure 167. Data or information flow from the import value added to import butcher in the small stock supply chain.

5.2.6.8 Import Food Services

The food service sector includes those businesses which prepare meat products for consumption outside the home and may include schools, catering, cafes, restaurants, and other eateries. Product may be received in carcass or cartoned form and be sourced directly from the processor cold stores, third-party cold store, or value-adder. After preparation (curing or cooking) meals are purchased by the consumer.

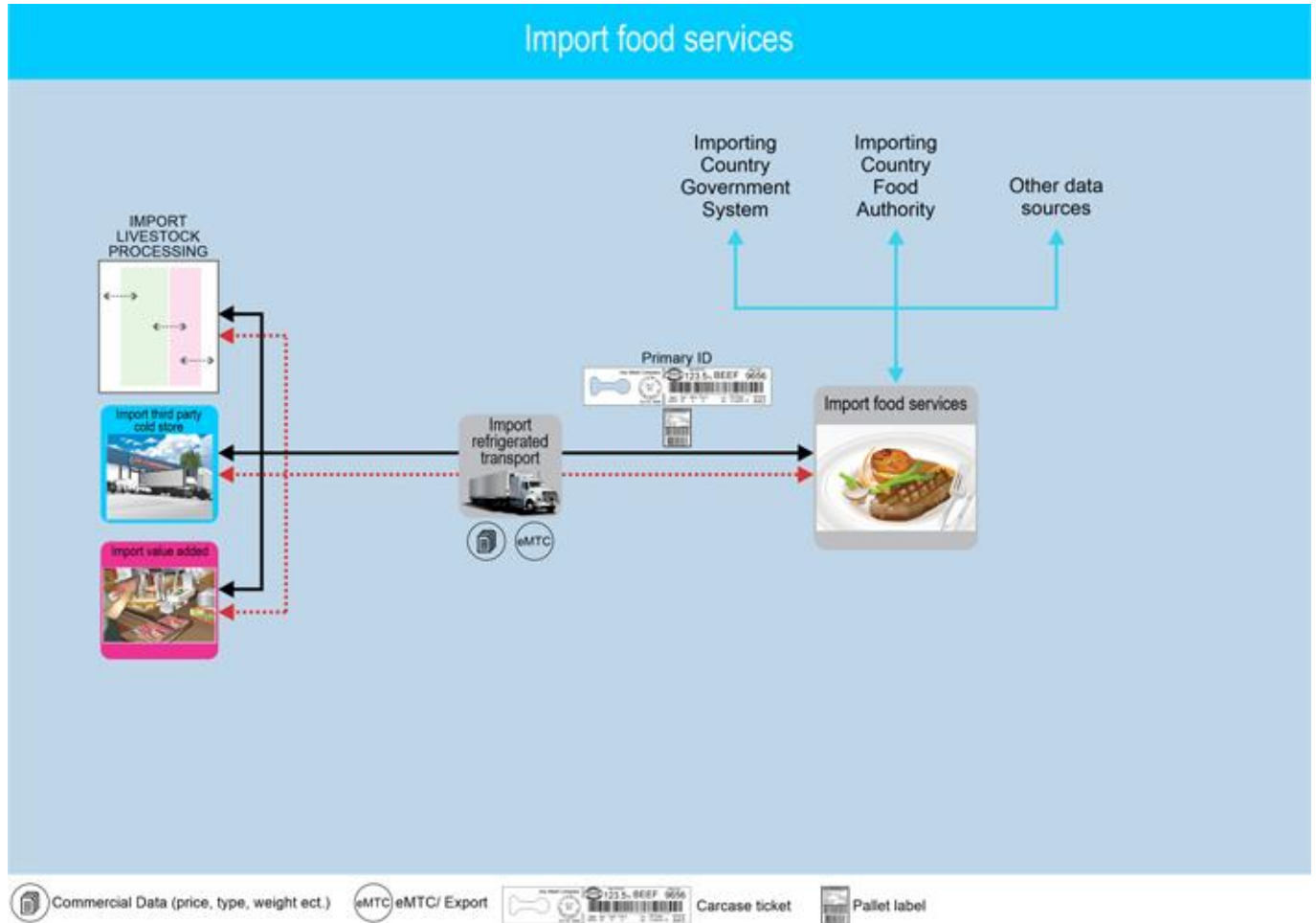

Figure 168. Inputs and outputs of the small stock supply chain import food services sector.

5.2.6.8.1 Physical Inputs including Critical Tracking Events (CTEs)

The inputs to the food service system include carcass, carton or palletised product. Critical Tracking Event related documentation for the movement of product into the food service system includes standard movement documentation such as the Delivery Docket/Manifest, import specific meat/meat product movement forms, carton, and pallet labels.

Critical Tracking Events (CTEs) are defined as those events which include the growing, receiving, transforming, creating and shipping of food products. Such events are critical to the traceability of product throughout the supply chain.

The CTEs associated with inputs to the import food services system include the receipt of:

- Carcase
- Carton
- Pallet.

Table 149. Physical inputs and associated Critical Tracking Event related documents for a small stock import food services system.

Event related to the inputs	Description of the inputs	Critical Tracking Event (CTE) related documents (including electronic)	More details
Carcase	The body of a slaughtered animal after bleeding. Becomes a dressed carcass when hide/skin, head, feet, and offal are removed.	Carcass Ticket, Delivery Docket/Manifest, Import specific meat/meat product movement forms, Retail production management system, Import Receipt of purchase/Tax Invoice	
Carton	This is a case, crate, or barrel of product.	Carton label, Delivery Docket/Manifest, Import specific meat/meat product movement forms, Retail production management system, Import Receipt of purchase/Tax Invoice	
Pallet	A logistic unit which includes a number of cartons or goods items packed together for transport or storage purposes.	Delivery Docket/Manifest, Import specific meat/meat product movement forms, Retail production management system, Import Receipt of purchase/Tax Invoice, SSCC/Pallet label	

5.2.6.8.2 Information Inputs including Key Data Elements (KDEs)

Key Data Elements (KDEs) are defined as those elements which are key in identifying and tracing the Critical Tracking Event (CTE). Information inputs or KDEs for the movement of meat product into the food service system can be found on Critical Tracking Event related documentation and may be stored in the retailer's production management system.

Table 150. Information inputs, Key Data Elements and Critical Tracking Event related documentation for a small stock import food services system.

Attributes (including KDEs)	Description of the Attributes (including KDEs)	Is a KDE	Critical Tracking Event (CTE) related documents (including electronic)	More details
Batch number	This is a unique number which identifies products sharing certain production characteristics and is used for traceability purposes.	Yes	Carcass Ticket, Retail production management system, Carcass Ticket, Retail production management system	
Company/product code	This is an in-house code for the identification of the product in the unit.	Yes	Carton label, Import Receipt of purchase/Tax Invoice, Retail production management system, SSCC/Pallet label	
Consignment Serial Shipping Container Code (SSCC)	Encoded in the GS1 barcode, this is a unique number which identifies the individual logistic unit i.e., shipment/message that is assigned by the establishment constructing the unit. The SSCC remains the same for the life of the logistic unit.	Yes	Import specific meat/meat product movement forms, Retail production management system, SSCC/Pallet label	For more information visit the GS1 website.

Contract number	This is a unique number allocated to the contract by the seller.	Yes	Delivery Docket/Manifest, Retail production management system	
Count of Trade Items	Usually encoded in the GS1 barcode, this is the number of trade items e.g., cartons in the logistic unit.	Yes	Delivery Docket/Manifest, Retail production management system, SSCC/Pallet label	For more information visit the GS1 website.
Date	This is the date of signing or of which a record entry or transaction was made.	Yes	Delivery Docket/Manifest, Import Receipt of purchase/Tax Invoice, Import specific meat/meat product movement forms, Retail production management system	
Delivery Docket/Manifest number	This is a unique number allocated to the docket for identification purposes.	Yes	Delivery Docket/Manifest, Retail production management system	
From Establishment number	A number issued by Federal and State Authorities to identify the originating site from which meat or meat products were distributed to domestic or export markets. For transfer certificates, the Establishment numbers for both the dispatching and receiving establishments are recorded.	Yes	Carcase Ticket, Carton label, Delivery Docket/Manifest, Retail production management system, SSCC/Pallet label	
From property identifier	The identification of the property (may be a PIC) from/to where the livestock or product were consigned.	Yes	Import specific meat/meat product movement forms, Retail production management system	
Global Trade Item Number (GTIN)	Encoded in the GS1 barcode, the GTIN is a globally unique 14-digit number used to identify trade items, products, or services.	Yes	Carcase Ticket, Carton label, Retail production management system, SSCC/Pallet label	For more information visit the GS1 website.
GTIN of Contained Trade Items	Encoded in the GS1 barcode, the GTIN of the contained trade items is a globally unique 14-digit number used to identify trade items, products, or services in the logistic unit.	Yes	Retail production management system, SSCC/Pallet label	For more information visit the GS1 website.
Lot number	A lot is a number assigned by the processor to each group of livestock consigned to slaughter and is usually vendor specific.	Yes	Carcase Ticket, Retail production management system	
Meat/meat product movement form number	A unique certificate number issued for traceability purposes.	Yes	Import specific meat/meat product movement forms, Retail production management system	

Movement date	The date on which livestock or other products (e.g., feed or meat products) were transported between PICs/establishments.	Yes	Delivery Docket/Manifest, Import specific meat/meat product movement forms, Retail production management system	
Net Weight (Kilograms)	Usually encoded in the GS1 barcode, the Net Weight is a variable measure of the trade item e.g., carton, pallet or shipment recorded in kilograms.	Yes	Carcase Ticket, Carton label, Retail production management system, SSCC/Pallet label	For more information visit the GS1 website.
Official mark	Any stamp, seal, label, or mark that is declared by the regulations to be an official mark. An official mark signifies that the product has been inspected by and approved as safe for human consumption by an Authorised Officer.	Yes	Carcase Ticket, Carton label, Retail production management system, SSCC/Pallet label	
Order date	This is the date on which the purchase order or contract was raised by the buyer.	Yes	Delivery Docket/Manifest Retail production management system	
Packaging Date	Encoded in the GS1 barcode, the Packaging Date is the date on which the item was packaged and is recorded in the format year, month, day (YYMMDD).	Yes	Carton label, Retail production management system, SSCC/Pallet label	For more information visit the GS1 website.
Packaging Date Range	This includes the oldest and newest packaging dates for the logistic unit.	Yes	Retail production management system, SSCC/Pallet label	For more information visit the GS1 website.
Pallet Serial Shipping Container Code (SSCC)	Encoded in the GS1 barcode, this is a unique number which identifies the individual logistic unit i.e., pallet that is assigned by the establishment constructing the unit. The SSCC remains the same for the life of the logistic unit.	Yes	Import specific meat/meat product movement forms, Retail production management system, SSCC/Pallet label	For more information visit the GS1 website.
Production Date (YYMMDD)	Encoded in the GS1 barcode, this is the 'kill' or slaughter' date of the product and is recorded in the format year, month, day (YYMMDD).	Yes	Carcase Ticket, Import specific meat/meat product movement forms, Retail production management system	For more information visit the GS1 website.
Recipient Business Number	This is a unique registration number, used to identify businesses.	Yes	Import Receipt of purchase/Tax Invoice, Retail production management system	
Seller/Supplier Business Number	This is a unique registration number, used to identify businesses.	Yes	Import Receipt of purchase/Tax Invoice, Retail production management system	
Serial Number	Encoded in the GS1 barcode, this is a code, numeric or alphanumeric, assigned to an individual instance of an item for its lifetime.	Yes	Carcase Ticket, Carton label, Retail production management system	For more information visit the GS1 website.
Shipping Mark	Also known as a port mark, this is a code comprising of three letters representing the	Yes	Delivery Docket/Manifest, Retail	

	foreign establishment number and the last nine digits of the consignment SSCC.		production management system, SSCC/Pallet label	
To property identifier	The identification of the property (may be a PIC) from/to where the livestock or product were consigned.	Yes	Import specific meat/meat product movement forms, Retail production management system	
Trade description	This is a collective set of words that says what the product is and may include information such as species, net weight of product, name and address of establishments, category ciphers, market endorsements, MSA eating quality etc.	Yes	Carcase Ticket, Carton label, Delivery Docket/Manifest, Retail production management system, SSCC/Pallet label	
Transport registration number	The registration number of the vehicle in which the animals or product were transported. For shipments of product this will be a shipping container number.	Yes	Delivery Docket/Manifest, Import specific meat/meat product movement forms, Retail production management system	

5.2.6.8.3 Physical Outputs including Critical Tracking Events (CTEs)

Retail-ready meat products are the outputs of the food service system. Being purchased by consumers, CTE documentation may include the product label and receipt of purchase. Product exiting the system may be recorded in the retailer's production management system.

Critical Tracking Events (CTEs) are defined as those events which include the growing, receiving, transforming, creating, and shipping of food products. Such events are critical to the traceability of product throughout the supply chain.

The CTEs associated with the outputs of the import food services system include the movement of:

- Retail Ready Product

off the property, premises, or supply chain sector.

Table 151. Physical outputs and associated Critical Tracking Event related documents for a small stock import food services system.

Event related to the inputs	Description of the inputs	Critical Tracking Event (CTE) related documents (including electronic)	More details
Retail Ready Product	These are packaged meat products that are ready to be retailed and purchased by consumers.	Import Receipt of purchase/Tax Invoice, Retail product label, Retail production management system	

5.2.6.8.4 Information Outputs including Key Data Elements (KDEs)

Key Data Elements (KDEs) are defined as those elements which are key in identifying and tracing the Critical Tracking Event (CTE). Information outputs from the food service system include KDEs which can be drawn from CTE documentation such as the product label and receipt of purchase. This may include purchase date, product code and application identifiers on the GS1 barcode.

Table 152. Information outputs, Key Data Elements and Critical Tracking Event related documentation for a small stock import food services system.

Attributes (including KDEs)	Description of the Attributes (including KDEs)	Is a KDE	Critical Tracking Event (CTE) related documents (including electronic)	More details
Company/product code	This is an in-house code for the identification of the product in the unit.	Yes	Import Receipt of purchase/Tax Invoice, Retail production management system	
Date	This is the date of signing or of which a record entry or transaction was made.	Yes	Import Receipt of purchase/Tax Invoice, Retail production management system	
GS1 compliant numbering and barcode	Numbering and barcode compliant to the GS1 standards and as specified by the contract between the seller and the recipient i.e., retailer.	Yes	Retail product label, Retail production management system	For more information visit the GS1 website.
Recipient Business Number	This is a unique registration number, used to identify businesses.	Yes	Import Receipt of purchase/Tax Invoice, Retail production management system	
Seller/Supplier Business Number	This is a unique registration number, used to identify businesses.	Yes	Import Receipt of purchase/Tax Invoice, Retail production management system	

5.2.6.8.5 Regulatory and Industry Programs

- Importing Country Government System
- Importing Country Food Authority
- Other data sources

5.2.6.8.6 Supply Chain Node Traceability

The traceability of retail-ready product back to the to the live animal (depending on the NLIS tag type), or consignment group and property of origin is dependent on the form in which product enters the retail premises. This may include whole carcass, cartoned or palletised form. Further, the level of traceability for each input form is dependent on the packaging processes of the retailer and the traceability requirements of the importing country. For example, whole carcass product may or may not be fully traceable back to the live animal or consignment group. Where this is true, carcasses are broken down into retail cuts on site and may be packaged individually and labelled with a unique, serialised retail label. For this product, traceability back to the live animal or consignment group is possible and can be done by the processing establishment where the animal was slaughtered as importers of livestock are required to demonstrate that animals remain traceable throughout the supply chain up to the point of slaughter. Here, carcasses are issued a carcass ticket which correlates to the live animal identifier and contains key information, including GS1 meat industry barcode, body number, processing establishment number and production date or 'kill date'. Thus, there is the potential to trace whole carcasses entering retail premises back to the individual live animal, or consignment group and property of origin. Where carcass retail cuts are not individually packaged or are derived from palletised or cartoned product, imported retail-ready product may have the same batch traceability limitations as per boning room and value-added

product. Please refer to Boning room and Value Added 'Supply Chain Node Traceability' for more detailed information.

5.2.6.8.7 Data flow diagrams

Table 153. Data flow diagrams for the inputs and outputs of a small stock import food services system.

Direction	Description
Input	Import Refrigerated Transport to Import Food Services
Input	Import Third Party Cold Store to Import Food Services
Input	Import Value Added to Import Food Services

5.2.6.8.7.1 Import Refrigerated Transport to Import Food Services

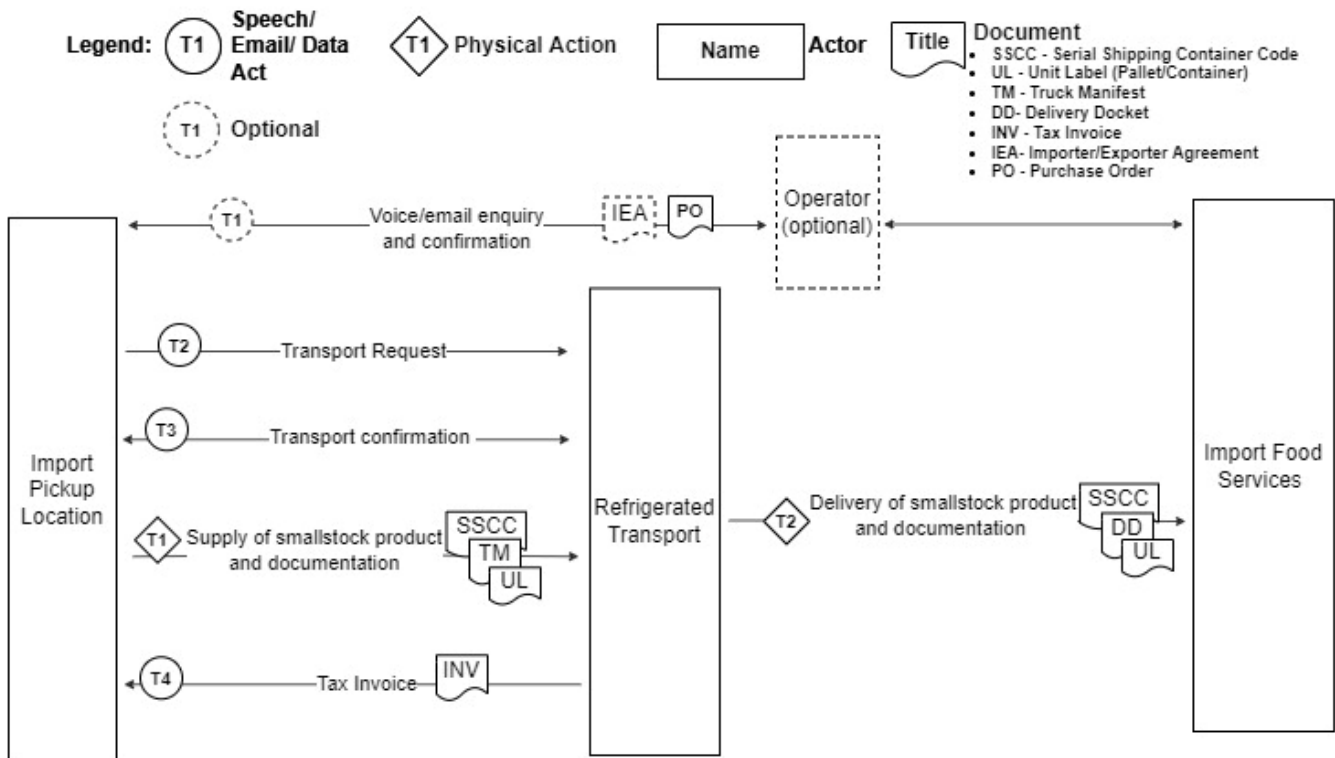

Import Refrigerated Transport

Figure 169. Data or information flow for the import refrigerated transport to import food services in the small stock supply chain.

5.2.6.8.7.2 Import Third Party Cold Store to Import Food Services

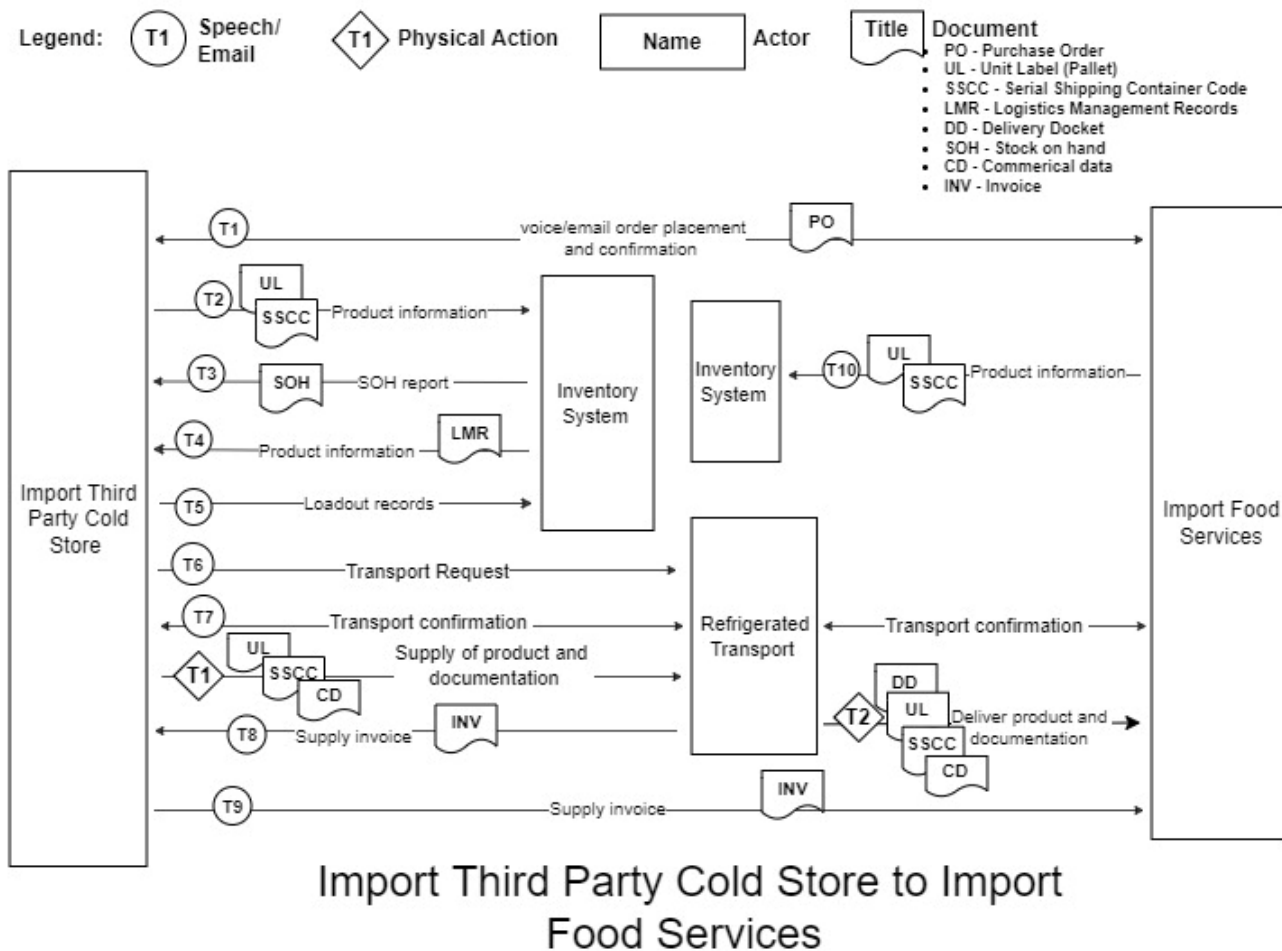

Figure 170. Data or information flows from the import third party cold store to import food services in the small stock supply chain.

5.2.6.8.7.3 Import Value Added to Import Food Services

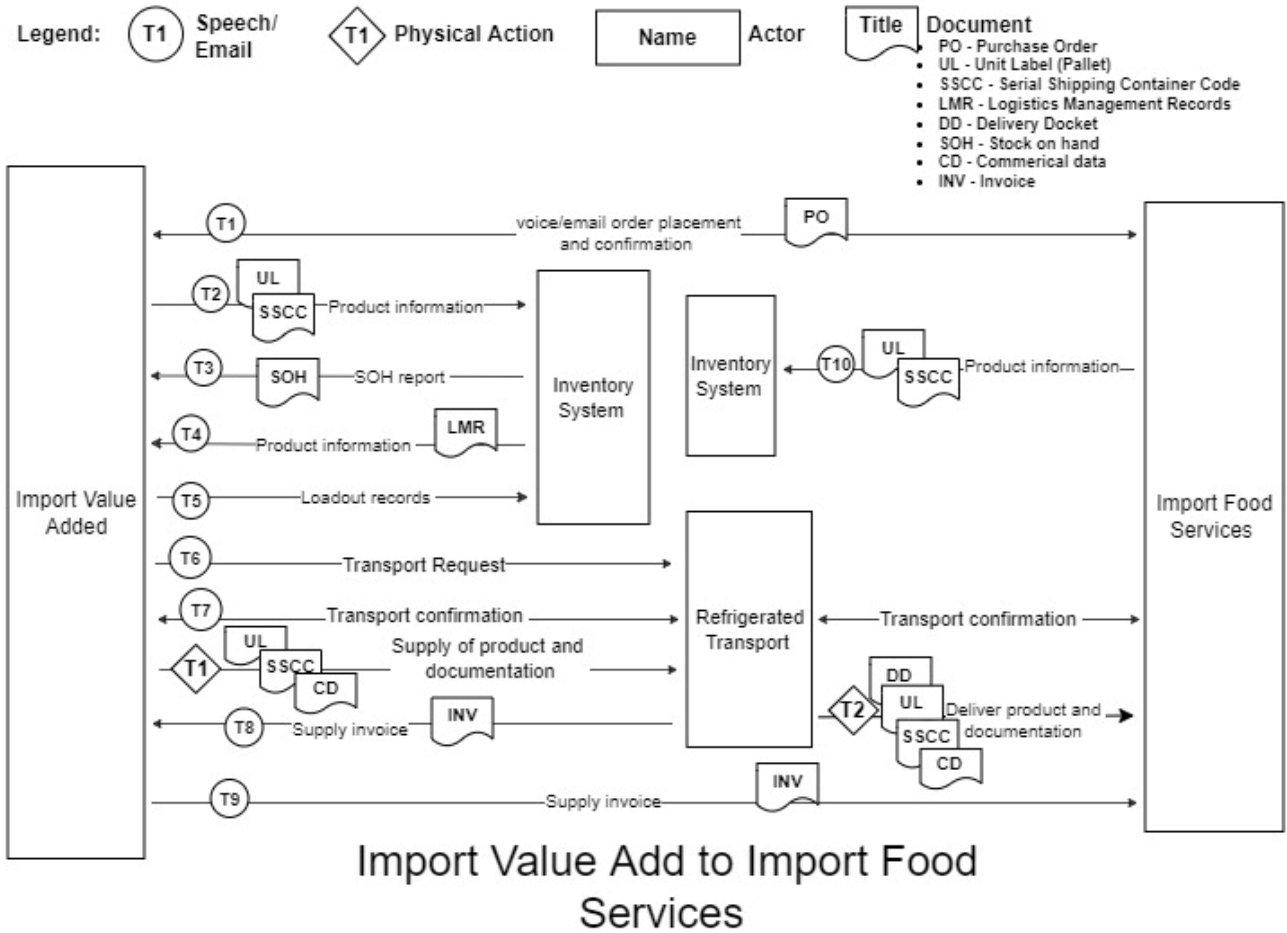

Figure 171. Data or information flows from the import value add to import food services in the small stock supply chain.

5.2.7 Importing Country - Cross-sector

5.2.7.1 Import livestock transport

Livestock transport is the process whereby animals are moved from one property to another by a mode of transport, most commonly truck. This journey requires careful preparation to ensure that animal stress, as well as any risks to welfare, are minimised. The importing country's livestock transport requirements and regulations are likely to be found within animal welfare standards and guidelines or legislation.

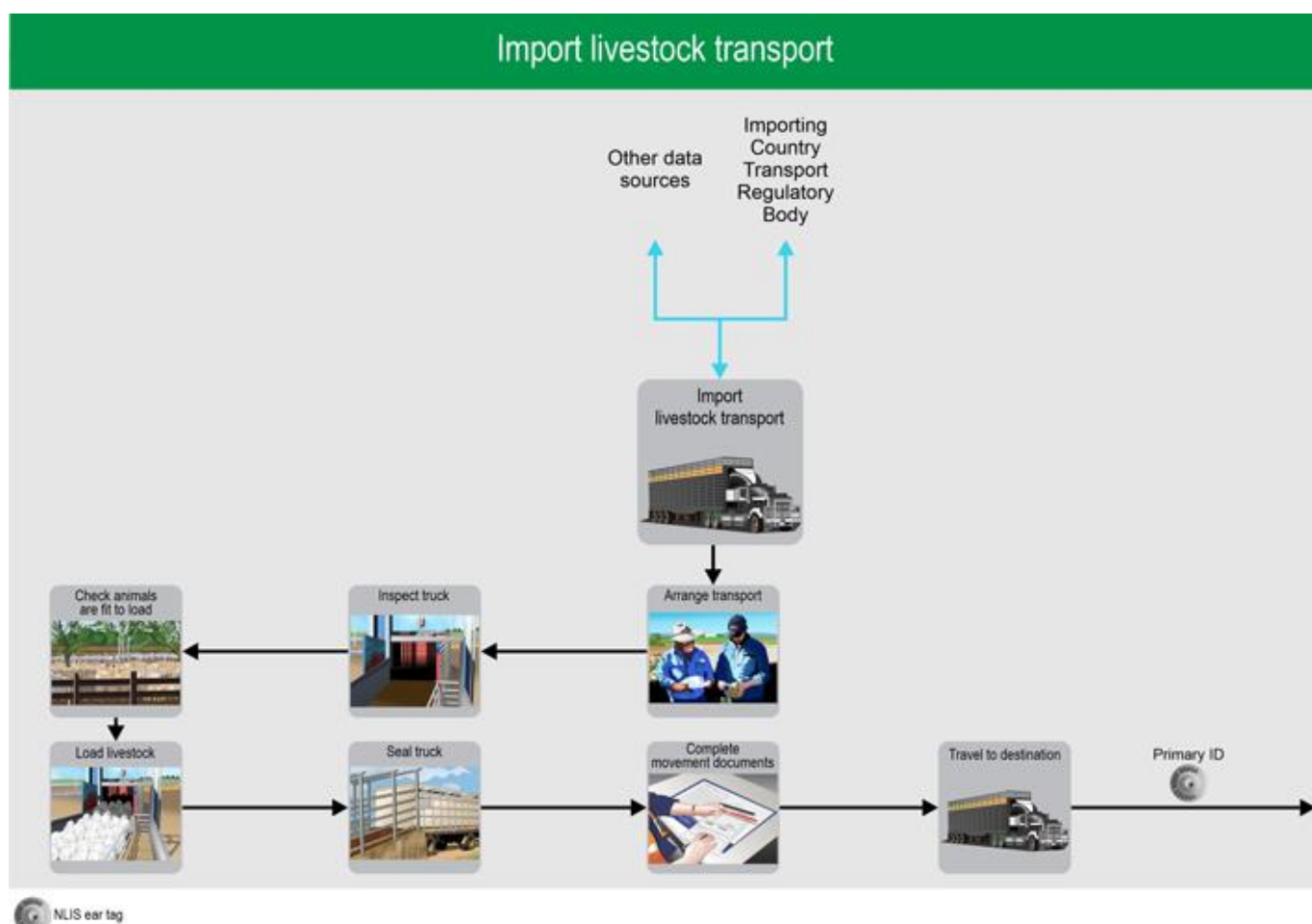

Figure 172. Inputs and outputs of the small stock supply chain import livestock transport sector.

5.2.7.1.1 Physical Inputs including Critical Tracking Events (CTEs)

There are few physical inputs for the transportation of livestock. Inputs not only include the small stock but those materials required to ensure that animal welfare standards and guidelines are met whilst livestock are in transit.

Critical Tracking Events (CTEs) are defined as those events which include the growing, receiving, transforming, creating and shipping of food products. Such events are critical to the traceability of product throughout the supply chain.

The CTEs associated with inputs to the import livestock transport system include the receipt of:

- Small livestock
- Feed supplies and supplements.

Table 154. Physical inputs and associated Critical Tracking Event related documents for a small stock import livestock transport system.

Event related to the inputs	Description of the inputs	Critical Tracking Event (CTE) related documents (including electronic)	More details
Small livestock	These are sheep or goat livestock and may include any class of animals e.g., weaners, ewe/nanny, ram/buck, cull livestock etc.	Commercial supply contract, Import feed and water record, Import specific livestock	

		movement forms, Import Receipt of purchase/Tax Invoice	
Feed supplies and supplements	These are supplementary animal feed products such as hay or silage fodder, or mineral supplements which are provided to ensure the production efficiency and health of livestock are maintained. This may also include clean drinking water e.g., where livestock are in transit or at saleyards.	Import specific commodity movement forms, Import Receipt of purchase/Tax Invoice	

5.2.7.1.2 Information Inputs including Key Data Elements (KDEs)

Key Data Elements (KDEs) are defined as those elements which are key in identifying and tracing the Critical Tracking Event (CTE). Information inputs for the movement of small stock are those related to the CTE documents and ensuring the health and welfare of the livestock themselves.

Table 155. Information inputs, Key Data Elements and Critical Tracking Event related documentation for a small stock import livestock transport system.

Attributes (including KDEs)	Description of the Attributes (including KDEs)	Is a KDE	Critical Tracking Event (CTE) related documents (including electronic)	More details
Agreement date	This is the date on which an agreement between two parties was made.	Yes	Commercial supply contract	
Company/product code	This is an in-house code for the identification of the product in the unit.	Yes	Import feed and water record, Import Receipt of purchase/Tax Invoice	
Contract number	This is a unique number allocated to the contract by the seller.	Yes	Commercial supply contract, Import specific commodity movement forms	
Date	This is the date of signing or of which a record entry or transaction was made.	Yes	Commercial supply contract, Import feed and water record, Import Receipt of purchase/Tax Invoice, Import specific commodity movement forms, Import specific livestock movement forms	
From property identifier	The identification of the property (may be a PIC) from/to where the livestock or product were consigned.	Yes	Import specific commodity movement forms, Import specific livestock movement forms	
Livestock Identifier	The importer of exported livestock must demonstrate that these livestock remain traceable throughout the supply chain up to the point of slaughter. Livestock must be effectively identified, and all movements recorded to allow traceability back to the property of birth in the exporting country.	Yes	Import specific livestock movement forms	
Livestock movement form serial number	A unique certificate number issued for traceability purposes.	Yes	Import specific livestock movement forms	

Movement date	The date on which livestock or other products (e.g., feed or meat products) were transported between PICs/establishments.	Yes	Commercial supply contract, Import specific commodity movement forms, Import specific livestock movement forms	
Product code/description	This is a unique identifier or description assigned by the seller to each product type marketed or for sale.	Yes	Import specific commodity movement forms	
Recipient Business Number	This is a unique registration number, used to identify businesses.	Yes	Import feed and water record, Import Receipt of purchase/Tax Invoice	
Seller/Supplier Business Number	This is a unique registration number, used to identify businesses.	Yes	Import feed and water record, Import Receipt of purchase/Tax Invoice	
To property identifier	The identification of the property (may be a PIC) from/to where the livestock or product were consigned.	Yes	Import specific commodity movement forms, Import specific livestock movement forms	
Transport registration number	The registration number of the vehicle in which the animals or product were transported.	Yes	Import specific livestock movement forms	
Treatment date	The date on which a treatment or product was applied to a unit e.g., paddock, animal, fodder etc.	Yes	Import feed and water record	

5.2.7.1.3 Physical Outputs including Critical Tracking Events (CTEs)

Physical outputs for the transportation of small stock are limited to the livestock themselves.

Critical Tracking Events (CTEs) are defined as those events which include the growing, receiving, transforming, creating, and shipping of food products. Such events are critical to the traceability of product throughout the supply chain.

The CTEs associated with the outputs of the import livestock transport system include the movement of:

- Small livestock

off the property, premises, or supply chain sector.

Table 156. Physical outputs and associated Critical Tracking Event related documents for a small stock import livestock transport system.

Event related to the inputs	Description of the inputs	Critical Tracking Event (CTE) related documents (including electronic)	More details
Small livestock	These are sheep or goat livestock and may include any class of animals e.g., weaners, ewe/nanny, ram/buck, cull livestock etc.	Commercial supply contract, Import feed and water record, Import specific livestock movement forms, Import Receipt of purchase/Tax Invoice	

5.2.7.1.4 Information Outputs including Key Data Elements (KDEs)

Key Data Elements (KDEs) are defined as those elements which are key in identifying and tracing the Critical Tracking Event (CTE). Information outputs related to livestock transport include that pertaining to the livestock themselves such as the individual animal identifier and any information to be passed on from feed and water records, as well as all other documents critical to the traceability of livestock movements.

Table 157. Information outputs, Key Data Elements and Critical Tracking Event related documentation for a small stock import livestock transport system.

Attributes (including KDEs)	Description of the Attributes (including KDEs)	Is a KDE	Critical Tracking Event (CTE) related documents (including electronic)	More details
Agreement date	This is the date on which an agreement between two parties was made.	Yes	Commercial supply contract	
Company/product code	This is an in-house code for the identification of the product in the unit.	Yes	Import feed and water record, Import Receipt of purchase/Tax Invoice	
Contract number	This is a unique number allocated to the contract by the seller.	Yes	Commercial supply contract	
Date	This is the date of signing or of which a record entry or transaction was made.	Yes	Commercial supply contract, Import feed and water record, Import Receipt of purchase/Tax Invoice, Import specific livestock movement forms	
From property identifier	The identification of the property (may be a PIC) from/to where the livestock or product were consigned.	Yes	Import specific livestock movement forms	
Livestock Identifier	The importer of exported livestock must demonstrate that these livestock remain traceable throughout the supply chain up to the point of slaughter. Livestock must be effectively identified, and all movements recorded to allow traceability back to the property of birth in the exporting country.	Yes	Import specific livestock movement forms	
Livestock movement form serial number	A unique certificate number issued for traceability purposes.	Yes	Import specific livestock movement forms	
Movement date	The date on which livestock or other products (e.g., feed or meat products) were transported between PICs/establishments.	Yes	Commercial supply contract, Import specific livestock movement forms	
Recipient Business Number	This is a unique registration number, used to identify businesses.	Yes	Import feed and water record, Import Receipt of purchase/Tax Invoice	
Seller/Supplier Business Number	This is a unique registration number, used to identify businesses.	Yes	Import feed and water record, Import Receipt	

			of purchase/Tax Invoice	
To property identifier	The identification of the property (may be a PIC) from/to where the livestock or product were consigned.	Yes	Import specific livestock movement forms	
Transport registration number	The registration number of the vehicle in which the animals or product were transported.	Yes	Import specific livestock movement forms	
Treatment date	The date on which a treatment or product was applied to a unit e.g., paddock, animal, fodder etc.	Yes	Import feed and water record	

5.2.7.1.5 Regulatory and Industry Programs

- Importing Country Transport Regulatory Body
- Other data sources

5.2.7.1.6 Supply Chain Node Traceability

The National Livestock Identification System (NLIS) is Australian livestock traceability program which is administered by Integrity Systems Company (ISC). Where stipulated by State legislation and certain export markets, the NLIS system requires all animals bought, sold, and moved along the supply chain to be tagged with an accredited NLIS ID tag. In some states, these tags require only the visual display of the Property Identification Code (PIC), while other states require each tag to have an individualised NLIS tag number or Radio Frequency Identifier (RFID) for the traceability of the animal throughout its lifetime. Every property which holds livestock must have a Property Identification Code (PIC) to which the livestock are assigned in the NLIS Database. Each time livestock are transferred between PICs within Australia they must be accompanied by a livestock movement declaration, such as the National Vendor Declaration (NVD) form. This document typically outlines the transporter details, consignment details, compliance with intended market specifications, withholding periods, and the details of the new property PIC. All livestock movements between PICs require an NLIS movement update to be made by either or both the consigner and receiver. Where NLIS ID tags are lost, livestock must be issued with a new post-breeder tag if not on the PIC of birth and this reconciled in the NLIS Database. For animals loaded for live export, it is the exporters responsibility to ensure that all livestock are transferred from the port PIC to EEEEEEEE (8Es) which signifies that livestock have been exported. The importer of exported livestock must demonstrate that these livestock remain traceable throughout the supply chain up to the point of slaughter. Livestock must be effectively identified, and all movements recorded to allow traceability back to the property of birth in the exporting country i.e., Australia.

5.2.7.1.7 Data flow diagrams

Table 158. Data flow diagrams for the inputs and outputs of a small stock livestock transport system.

Direction	Description
Input	Livestock Transport

5.2.7.1.7.1 Livestock Transport

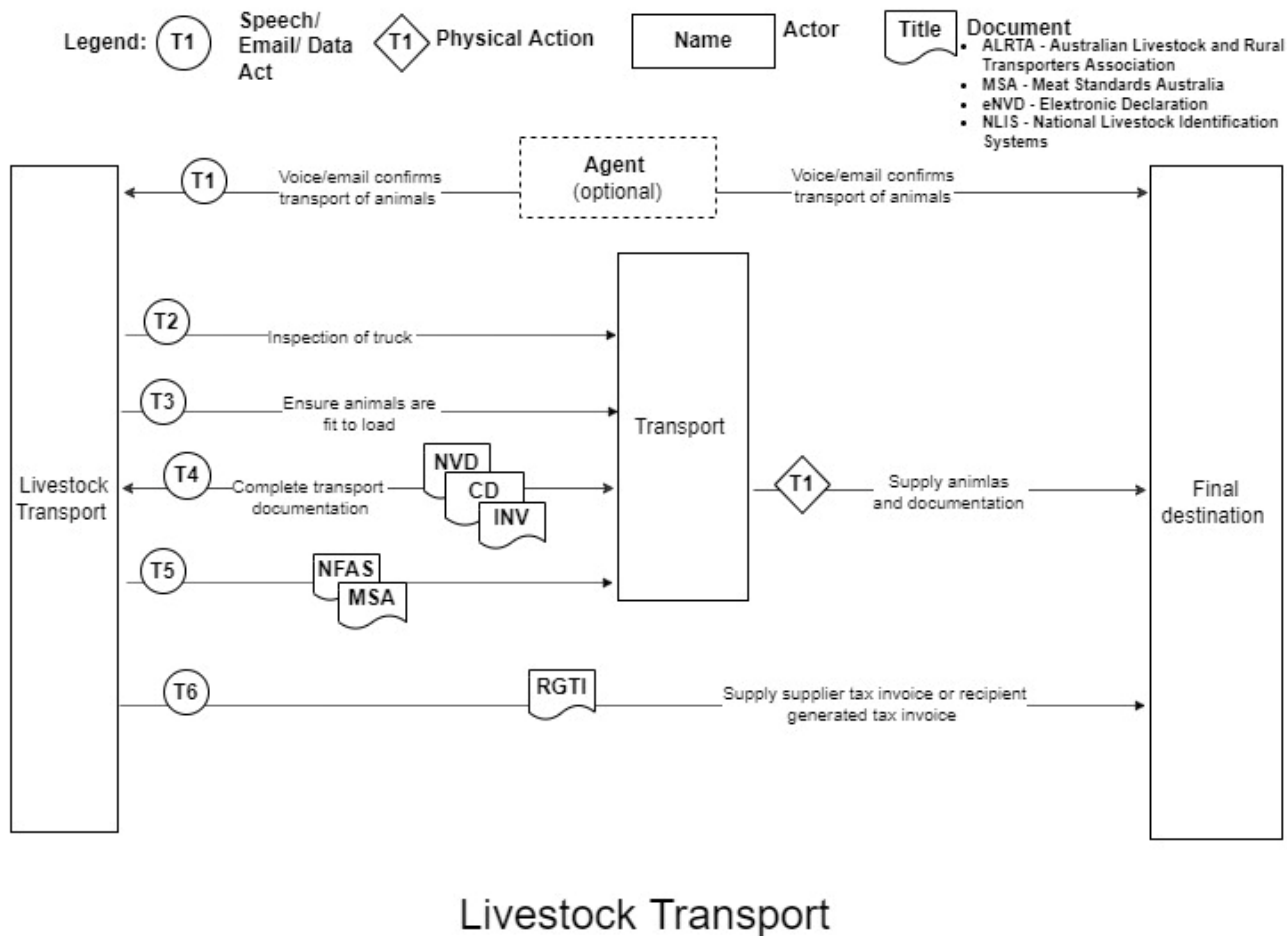

Figure 173. Data or information flow from the livestock transport in the small stock supply chain.

5.2.7.2 Import refrigerated transport

Refrigerated transport involves the movement (including loading and unloading) of meat and meat products from one premises to another under conditions which ensure that product integrity and wholesomeness are maintained. Ensuring that adequate hygiene and temperature controls are complied with is integral to successful refrigerated transport. Product may be in carcase, cartoned, or palletised form and must be accompanied by Critical Tracking Event related documents such as delivery dockets and specific product movement documents.

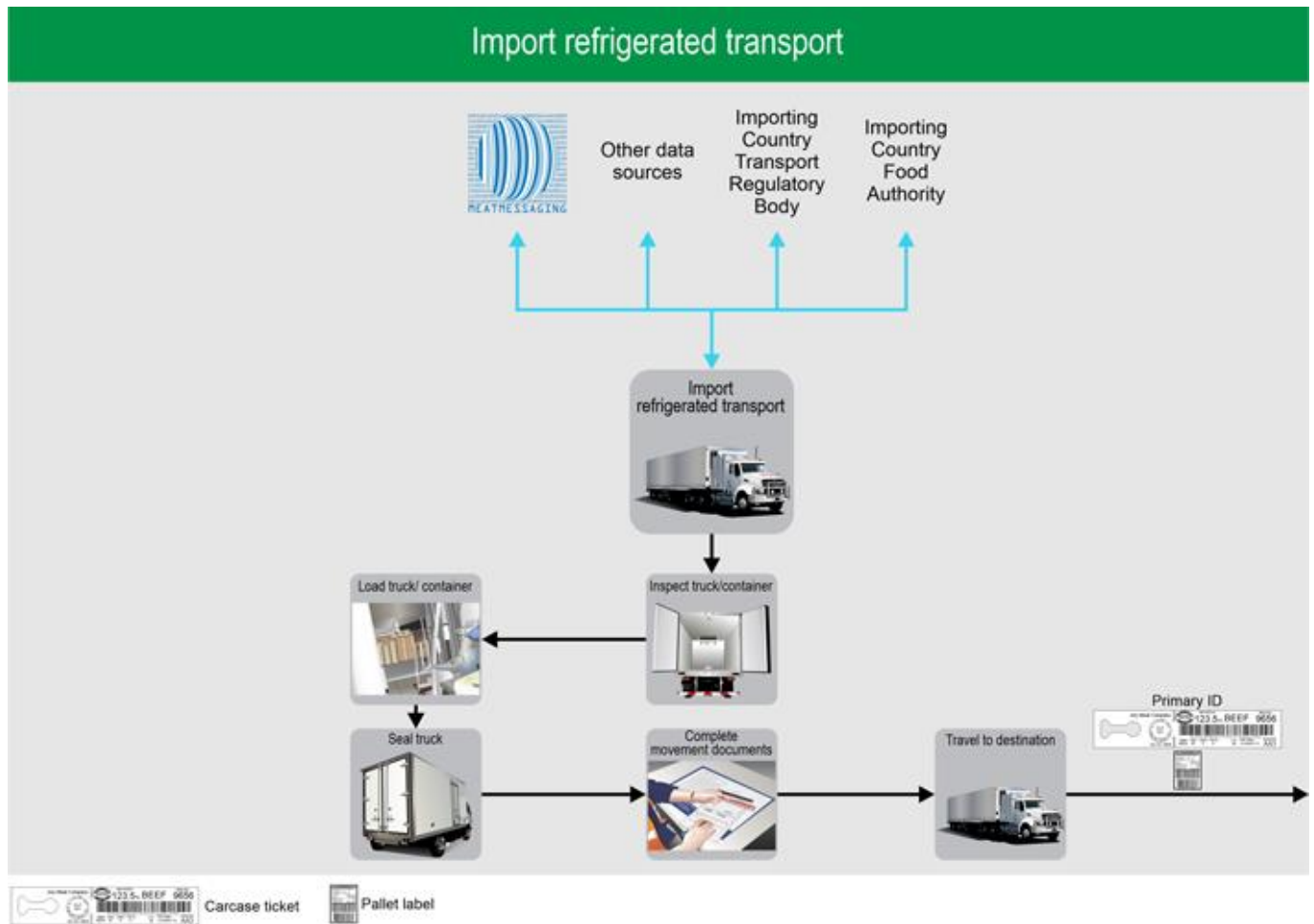

Figure 174. Inputs and outputs of the small stock supply chain import refrigerated transport sector.

5.2.7.2.1 Physical Inputs including Critical Tracking Events (CTEs)

Meat and meat products may be transported between various establishments such as import inspection facilities, meat processors, value adding facilities and retailing premises. Therefore, the physical inputs to the refrigerated transport process may take various forms including product in carcase, carton or palletised form or product packed into shipping containers received from exporters.

Critical Tracking Events (CTEs) are defined as those events which include the growing, receiving, transforming, creating, and shipping of food products. Such events are critical to the traceability of product throughout the supply chain.

The CTEs associated with inputs to the import refrigerated transport system include the receipt of:

- Carcase
- Carton
- Pallet
- Container System Unit (meat and meat products).

Table 159. Physical inputs and associated Critical Tracking Event related documents for a small stock import refrigerated transport system.

Event related to the inputs	Description of the inputs	Critical Tracking Event (CTE) related documents (including electronic)	More details
Carcase	The body of a slaughtered animal after bleeding. Becomes a dressed carcass when hide/skin, head, feet, and offal are removed.	Carcass Ticket, Delivery Docket/Manifest, Import specific meat/meat product movement forms, Import Receipt of purchase/Tax Invoice	
Carton	This is a case, crate, or barrel of product.	Carton label, Delivery Docket/Manifest, Import specific meat/meat product movement forms, Import Receipt of purchase/Tax Invoice	
Pallet	A logistic unit which includes a number of cartons or goods items packed together for transport or storage purposes.	Delivery Docket/Manifest, Import specific meat/meat product movement forms, Import Receipt of purchase/Tax Invoice, SSCC/Pallet label	
Container System Unit (meat and meat products)	A container designed for use as a unit of cargo handling equipment in the transport of goods by aircraft or ship.	Certificate of Analysis (COA), Delivery Docket/Manifest, Import Permit, Import specific meat/meat product movement forms, Imported Food Inspection Advice, Import Receipt of purchase/Tax Invoice	

5.2.7.2.2 Information Inputs including Key Data Elements (KDEs)

Key Data Elements (KDEs) are defined as those elements which are key in identifying and tracing the Critical Tracking Event (CTE). Transport of product between establishments is a Critical Tracking Event. Therefore, the KDEs here can largely be found on transportation documentation such as the Bill of lading/Air Waybill, Meat Transfer Certificate (MTC) or import specific meat/meat product movement forms, Export Health Certificate and Certificate of Analysis. Other documentation such as carcass tickets or carton/pallet labels will also contain KDEs.

Table 160. Information inputs, Key Data Elements and Critical Tracking Event related documentation for a small stock import refrigerated transport system.

Attributes (including KDEs)	Description of the Attributes (including KDEs)	Is a KDE	Critical Tracking Event (CTE) related documents (including electronic)	More details
Analysis Date	This is the date on which a product sample was analysed.	Yes	Certificate of Analysis (COA), Imported Food Inspection Advice	
Batch number	This is a unique number which identifies products sharing certain production characteristics and is used for traceability purposes.	Yes	Carcass Ticket	
Bill of lading/Air Waybill document number	A unique document number issued for traceability purposes.	Yes	Certificate of Analysis (COA)	
Body number	This is a number assigned to each carcass by the processor for identification purposes.	Yes	Carcass Ticket	
Certificate of Analysis number	A unique certificate number issued for traceability purposes.	Yes	Certificate of Analysis (COA), Imported Food Inspection Advice	

COA test lot identifier	This is a unique identifier allocated to all cartons, pallets, and shipping containers for which an analysis sample represents.	Yes	Certificate of Analysis (COA), Imported Food Inspection Advice	
Company/product code	This is an in-house code for the identification of the product in the unit.	Yes	Carton label, Certificate of Analysis (COA), Import Receipt of purchase/Tax Invoice, Imported Food Inspection Advice, SSCC/Pallet label	
Consignment Serial Shipping Container Code (SSCC)	Encoded in the GS1 barcode, this is a unique number which identifies the individual logistic unit i.e., shipment/message that is assigned by the establishment constructing the unit. The SSCC remains the same for the life of the logistic unit.	Yes	Import specific meat/meat product movement forms, Imported Food Inspection Advice, SSCC/Pallet label	For more information visit the GS1 website.
Contract number	This is a unique number allocated to the contract by the seller.	Yes	Delivery Docket/Manifest	
Count of Trade Items	Usually encoded in the GS1 barcode, this is the number of trade items e.g., cartons in the logistic unit.	Yes	Delivery Docket/Manifest, Imported Food Inspection Advice, SSCC/Pallet label	For more information visit the GS1 website.
Date	This is the date of signing or of which a record entry or transaction was made.	Yes	Certificate of Analysis (COA), Delivery Docket/Manifest, Import Receipt of purchase/Tax Invoice, Import specific meat/meat product movement forms	
Delivery Docket/Manifest number	This is a unique number allocated to the docket for identification purposes.	Yes	Delivery Docket/Manifest	
Food Control Certificate entry number	This is a number assigned to the entry of a shipment of goods imported by the same owner at the same time which can be described by one import entry.	Yes	Imported Food Inspection Advice	
From Establishment number	A number issued by Federal and State Authorities to identify the originating site from which meat or meat products were distributed to domestic or export markets. For transfer certificates, the Establishment numbers for both the dispatching and receiving establishments are recorded.	Yes	Carcase Ticket, Carton label, Certificate of Analysis (COA), Delivery Docket/Manifest, SSCC/Pallet label	
From property identifier	The identification of the property (may be a PIC) from/to where the livestock or product were consigned.	Yes	Import specific meat/meat product movement forms	
Global Trade Item Number (GTIN)	Encoded in the GS1 barcode, the GTIN is a globally unique 14-digit number used to identify trade items, products, or services.	Yes	Carcase Ticket, Carton label, SSCC/Pallet label	For more information visit the GS1 website.

GTIN of Contained Trade Items	Encoded in the GS1 barcode, the GTIN of the contained trade items is a globally unique 14-digit number used to identify trade items, products, or services in the logistic unit.	Yes	SSCC/Pallet label	For more information visit the GS1 website.
Import Permit Number	A unique permit number is allocated for the import consignment following submission of correct and validated documentation approved by the importing country.	Yes	Import Permit	
Imported Food Inspection Advice certificate number	A unique certificate number issued for traceability purposes.	Yes	Imported Food Inspection Advice	
Lot number	A lot is a number assigned by the processor to each group of livestock consigned to slaughter and is usually vendor specific.	Yes	Carcase Ticket	
Meat/meat product movement form number	A unique certificate number issued for traceability purposes.	Yes	Import specific meat/meat product movement forms	
Movement date	The date on which livestock or other products (e.g., feed or meat products) were transported between PICs/establishments.	Yes	Certificate of Analysis (COA), Delivery Docket/Manifest, Import specific meat/meat product movement forms	
Net Weight (Kilograms)	Usually encoded in the GS1 barcode, the Net Weight is a variable measure of the trade item e.g., carton, pallet or shipment recorded in kilograms.	Yes	Carcase Ticket, Carton label, SSCC/Pallet label	For more information visit the GS1 website.
Official mark	Any stamp, seal, label, or mark that is declared by the regulations to be an official mark. An official mark signifies that the product has been inspected by and approved as safe for human consumption by an Authorised Officer.	Yes	Carcase Ticket, Carton label, SSCC/Pallet label	
Order date	This is the date on which the purchase order or contract was raised by the buyer.	Yes	Delivery Docket/Manifest	
Packaging Date	Encoded in the GS1 barcode, the Packaging Date is the date on which the item was packaged and is recorded in the format year, month, day (YYMMDD).	Yes	Carton label, Certificate of Analysis (COA), SSCC/Pallet label	For more information visit the GS1 website.
Packaging Date Range	This includes the oldest and newest packaging dates for the logistic unit.	Yes	SSCC/Pallet label	For more information visit the GS1 website.
Pallet Serial Shipping Container Code (SSCC)	Encoded in the GS1 barcode, this is a unique number which identifies the individual logistic unit i.e., pallet that is assigned by the establishment constructing the unit. The SSCC remains the same for the life of the logistic unit.	Yes	Import specific meat/meat product movement forms, SSCC/Pallet label	For more information visit the GS1 website.

Production Date (YYMMDD)	Encoded in the GS1 barcode, this is the 'kill' or slaughter' date of the product and is recorded in the format year, month, day (YYMMDD).	Yes	Carcase Ticket, Certificate of Analysis (COA), Import specific meat/meat product movement forms	For more information visit the GS1 website.
Recipient Business Number	This is a unique registration number, used to identify businesses.	Yes	Import Receipt of purchase/Tax Invoice	
Seller/Supplier Business Number	This is a unique registration number, used to identify businesses.	Yes	Import Receipt of purchase/Tax Invoice	
Serial Number	Encoded in the GS1 barcode, this is a code, numeric or alphanumeric, assigned to an individual instance of an item for its lifetime.	Yes	Carcase Ticket, Carton label	For more information visit the GS1 website.
Shipping Mark	Also known as a port mark, this is a code comprising of three letters representing the foreign establishment number and the last nine digits of the consignment SSCC.	Yes	Certificate of Analysis (COA), Delivery Docket/Manifest, SSCC/Pallet label	
To property identifier	The identification of the property (may be a PIC) from/to where the livestock or product were consigned.	Yes	Import specific meat/meat product movement forms	
Trade description	This is a collective set of words that says what the product is and may include information such as species, net weight of product, name and address of establishments, category ciphers, market endorsements, MSA eating quality etc.	Yes	Carcase Ticket, Carton label, Delivery Docket/Manifest, SSCC/Pallet label	
Transport registration number	The registration number of the vehicle in which the animals or product were transported. For shipments of product this will be a shipping container number.	Yes	Delivery Docket/Manifest, Import specific meat/meat product movement forms	

5.2.7.2.3 Physical Outputs including Critical Tracking Events (CTEs)

As the refrigerated transportation process involves the movement of product between establishments, the physical outputs are the same as for the physical inputs. This may include product in carcase, carton or palletised form or product packed into shipping containers received from exporters.

Critical Tracking Events (CTEs) are defined as those events which include the growing, receiving, transforming, creating, and shipping of food products. Such events are critical to the traceability of product throughout the supply chain.

The CTEs associated with the outputs of the import refrigerated transport system include the movement of:

- Carcase
- Carton
- Pallet
- Container System Unit (meat and meat products)

off the property, premises, or supply chain sector.

Table 161. Physical outputs and associated Critical Tracking Event related documents for a small stock import refrigerated transport system.

Event related to the inputs	Description of the inputs	Critical Tracking Event (CTE) related documents (including electronic)	More details
Carcase	The body of a slaughtered animal after bleeding. Becomes a dressed carcass when hide/skin, head, feet, and offal are removed.	Carcass Ticket, Delivery Docket/Manifest, Import specific meat/meat product movement forms, Import Receipt of purchase/Tax Invoice	
Carton	This is a case, crate, or barrel of product.	Carton label, Delivery Docket/Manifest, Import specific meat/meat product movement forms, Import Receipt of purchase/Tax Invoice	
Pallet	A logistic unit which includes a number of cartons or goods items packed together for transport or storage purposes.	Delivery Docket/Manifest, Import specific meat/meat product movement forms, Import Receipt of purchase/Tax Invoice, SSCC/Pallet label	
Container System Unit (meat and meat products)	A container designed for use as a unit of cargo handling equipment in the transport of goods by aircraft or ship.	Certificate of Analysis (COA), Delivery Docket/Manifest, Import Permit, Import specific meat/meat product movement forms, Imported Food Inspection Advice, Import Receipt of purchase/Tax Invoice	

5.2.7.2.4 Information Outputs including Key Data Elements (KDEs)

Key Data Elements (KDEs) are defined as those elements which are key in identifying and tracing the Critical Tracking Event (CTE). Transport of product between establishments is a Critical Tracking Event. Therefore, the KDEs here can largely be found on transportation documentation such as the Bill of lading/Air Waybill, Meat Transfer Certificate (MTC) or import specific meat/meat product movement forms, Export Health Certificate and Certificate of Analysis. Other documentation such as carcass tickets or carton/pallet labels will also contain KDEs.

Table 162. Information outputs, Key Data Elements and Critical Tracking Event related documentation for a small stock import refrigerated transport system.

Attributes (including KDEs)	Description of the Attributes (including KDEs)	Is a KDE	Critical Tracking Event (CTE) related documents (including electronic)	More details
Analysis Date	This is the date on which a product sample was analysed.	Yes	Certificate of Analysis (COA), Imported Food Inspection Advice	
Batch number	This is a unique number which identifies products sharing certain production characteristics and is used for traceability purposes.	Yes	Carcass Ticket	
Bill of lading/Air Waybill document number	A unique document number issued for traceability purposes.	Yes	Certificate of Analysis (COA)	
Body number	This is a number assigned to each carcass by the processor for identification purposes.	Yes	Carcass Ticket	
Certificate of Analysis number	A unique certificate number issued for traceability purposes.	Yes	Certificate of Analysis (COA), Imported Food Inspection Advice	

COA test lot identifier	This is a unique identifier allocated to all cartons, pallets, and shipping containers for which an analysis sample represents.	Yes	Certificate of Analysis (COA), Imported Food Inspection Advice	
Company/product code	This is an in-house code for the identification of the product in the unit.	Yes	Carton label, Certificate of Analysis (COA), Import Receipt of purchase/Tax Invoice, Imported Food Inspection Advice, SSCC/Pallet label	
Consignment Serial Shipping Container Code (SSCC)	Encoded in the GS1 barcode, this is a unique number which identifies the individual logistic unit i.e., shipment/message that is assigned by the establishment constructing the unit. The SSCC remains the same for the life of the logistic unit.	Yes	Import specific meat/meat product movement forms, Imported Food Inspection Advice, SSCC/Pallet label	For more information visit the GS1 website.
Contract number	This is a unique number allocated to the contract by the seller.	Yes	Delivery Docket/Manifest	
Count of Trade Items	Usually encoded in the GS1 barcode, this is the number of trade items e.g., cartons in the logistic unit.	Yes	Delivery Docket/Manifest, Imported Food Inspection Advice, SSCC/Pallet label	For more information visit the GS1 website.
Date	This is the date of signing or of which a record entry or transaction was made.	Yes	Certificate of Analysis (COA), Delivery Docket/Manifest, Import Receipt of purchase/Tax Invoice, Import specific meat/meat product movement forms	
Delivery Docket/Manifest number	This is a unique number allocated to the docket for identification purposes.	Yes	Delivery Docket/Manifest	
Food Control Certificate entry number	This is a number assigned to the entry of a shipment of goods imported by the same owner at the same time which can be described by one import entry.	Yes	Imported Food Inspection Advice	
From Establishment number	A number issued by Federal and State Authorities to identify the originating site from which meat or meat products were distributed to domestic or export markets. For transfer certificates, the Establishment numbers for both the dispatching and receiving establishments are recorded.	Yes	Carcase Ticket, Carton label, Certificate of Analysis (COA), Delivery Docket/Manifest, SSCC/Pallet label	
From property identifier	The identification of the property (may be a PIC) from/to where the livestock or product were consigned.	Yes	Import specific meat/meat product movement forms	
Global Trade Item Number (GTIN)	Encoded in the GS1 barcode, the GTIN is a globally unique 14-digit number used to identify trade items, products, or services.	Yes	Carcase Ticket, Carton label, SSCC/Pallet label	For more information visit the GS1 website.

GTIN of Contained Trade Items	Encoded in the GS1 barcode, the GTIN of the contained trade items is a globally unique 14-digit number used to identify trade items, products, or services in the logistic unit.	Yes	SSCC/Pallet label	For more information visit the GS1 website.
Import Permit Number	A unique permit number is allocated for the import consignment following submission of correct and validated documentation approved by the importing country.	Yes	Import Permit	
Imported Food Inspection Advice certificate number	A unique certificate number issued for traceability purposes.	Yes	Imported Food Inspection Advice	
Lot number	A lot is a number assigned by the processor to each group of livestock consigned to slaughter and is usually vendor specific.	Yes	Carcase Ticket	
Meat/meat product movement form number	A unique certificate number issued for traceability purposes.	Yes	Import specific meat/meat product movement forms	
Movement date	The date on which livestock or other products (e.g., feed or meat products) were transported between PICs/establishments.	Yes	Certificate of Analysis (COA), Delivery Docket/Manifest, Import specific meat/meat product movement forms	
Net Weight (Kilograms)	Usually encoded in the GS1 barcode, the Net Weight is a variable measure of the trade item e.g., carton, pallet or shipment recorded in kilograms.	Yes	Carcase Ticket, Carton label, SSCC/Pallet label	For more information visit the GS1 website.
Official mark	Any stamp, seal, label, or mark that is declared by the regulations to be an official mark. An official mark signifies that the product has been inspected by and approved as safe for human consumption by an Authorised Officer.	Yes	Carcase Ticket, Carton label, SSCC/Pallet label	
Order date	This is the date on which the purchase order or contract was raised by the buyer.	Yes	Delivery Docket/Manifest	
Packaging Date	Encoded in the GS1 barcode, the Packaging Date is the date on which the item was packaged and is recorded in the format year, month, day (YYMMDD).	Yes	Carton label, Certificate of Analysis (COA), SSCC/Pallet label	For more information visit the GS1 website.
Packaging Date Range	This includes the oldest and newest packaging dates for the logistic unit.	Yes	SSCC/Pallet label	For more information visit the GS1 website.
Pallet Serial Shipping Container Code (SSCC)	Encoded in the GS1 barcode, this is a unique number which identifies the individual logistic unit i.e., pallet that is assigned by the establishment constructing the unit. The SSCC remains the same for the life of the logistic unit.	Yes	Import specific meat/meat product movement forms, SSCC/Pallet label	For more information visit the GS1 website.
Production Date (YYMMDD)	Encoded in the GS1 barcode, this is the 'kill' or slaughter' date of the product and is	Yes	Carcase Ticket, Certificate of Analysis	For more information visit the

	recorded in the format year, month, day (YYMMDD).		(COA), Import specific meat/meat product movement forms	GS1 website.
Recipient Business Number	This is a unique registration number, used to identify businesses.	Yes	Import Receipt of purchase/Tax Invoice	
Seller/Supplier Business Number	This is a unique registration number, used to identify businesses.	Yes	Import Receipt of purchase/Tax Invoice	
Serial Number	Encoded in the GS1 barcode, this is a code, numeric or alphanumeric, assigned to an individual instance of an item for its lifetime.	Yes	Carcase Ticket, Carton label	For more information visit the GS1 website.
Shipping Mark	Also known as a port mark, this is a code comprising of three letters representing the foreign establishment number and the last nine digits of the consignment SSCC.	Yes	Certificate of Analysis (COA), Delivery Docket/Manifest, SSCC/Pallet label	
To property identifier	The identification of the property (may be a PIC) from/to where the livestock or product were consigned.	Yes	Import specific meat/meat product movement forms	
Trade description	This is a collective set of words that says what the product is and may include information such as species, net weight of product, name and address of establishments, category ciphers, market endorsements, MSA eating quality etc.	Yes	Carcase Ticket, Carton label, Delivery Docket/Manifest, SSCC/Pallet label	
Transport registration number	The registration number of the vehicle in which the animals or product were transported. For shipments of product this will be a shipping container number.	Yes	Delivery Docket/Manifest, Import specific meat/meat product movement forms	

5.2.7.2.5 Regulatory and Industry Programs

- Importing Country Transport Regulatory Body
- Importing Country Food Authority
- Other data sources
- Meat Messaging

5.2.7.2.6 Supply Chain Node Traceability

The traceability of imported product undergoing refrigerated transport back to the live animal, or consignment group and property of origin is dependent on the form in which the product is being transported.

Traceability of whole carcasses back to the live animal or consignment group is possible and can be done by the processing establishment where the animal was slaughtered as importers of livestock are required to demonstrate that animals remain traceable throughout the supply chain up to the point of slaughter. Here, carcasses are issued a carcass ticket which correlates to the live animal identifier and contains key information, including GS1 meat industry barcode, body number, processing establishment number and production date or 'kill date'. Thus, there is the potential to trace whole carcasses undergoing refrigerated transport back to the individual live animal, or consignment group and property of origin.

For cartoned and palletised product, each identified by unique serialised carton or product labels respectively, including a GS1 meat industry barcode, traceability is limited to the carcasses that have entered the boning room

for the production run of cartons that were created. For example, 200 carcasses individually identified with unique carcass tickets enter the boning room for a specific boning run. These carcass tickets are linked to the specific boning run. From these 200 cartons of primal cuts and 200 cartons of trim and other highly mixed products are created. While all cartons are identified with unique serialised carton labels, including a GS1 meat industry barcode, linked to the boning run (and may be packaged into pallets containing unique serialised pallet labels including a GS1 SSCC barcode), it is not readily possible to identify which carcasses are in which cartons as the cartons will contain meat products from different carcasses. If the carcasses were sourced from several different properties, the resulting carton can only be traced to a number of possible carcasses and source properties. In logistical systems such as transport and cold stores, cartons are typically processed by pallets with only the pallet label being scanned. Therefore, traceability through logistics is often at the pallet level.

Traceability requirements post slaughter differ depending on the importing country. Typically, product transferred between establishments will be accompanied by import specific meat/meat product movement forms which details the serialised logistic unit identifiers such as the Serial Shipping Container Code (SSCC). This allows traceability of the unit and its subunits back to either the live animal or consignment group and property of origin (for carcasses) or the boning room production run (for cartons and pallets).

5.2.7.2.7 Data flow diagrams

Table 163. Data flow diagrams for the inputs and outputs of a small stock import refrigerated transport system.

Direction	Description
Input	Import Refrigerated Transport

5.2.7.2.7.1 Import Refrigerated Transport

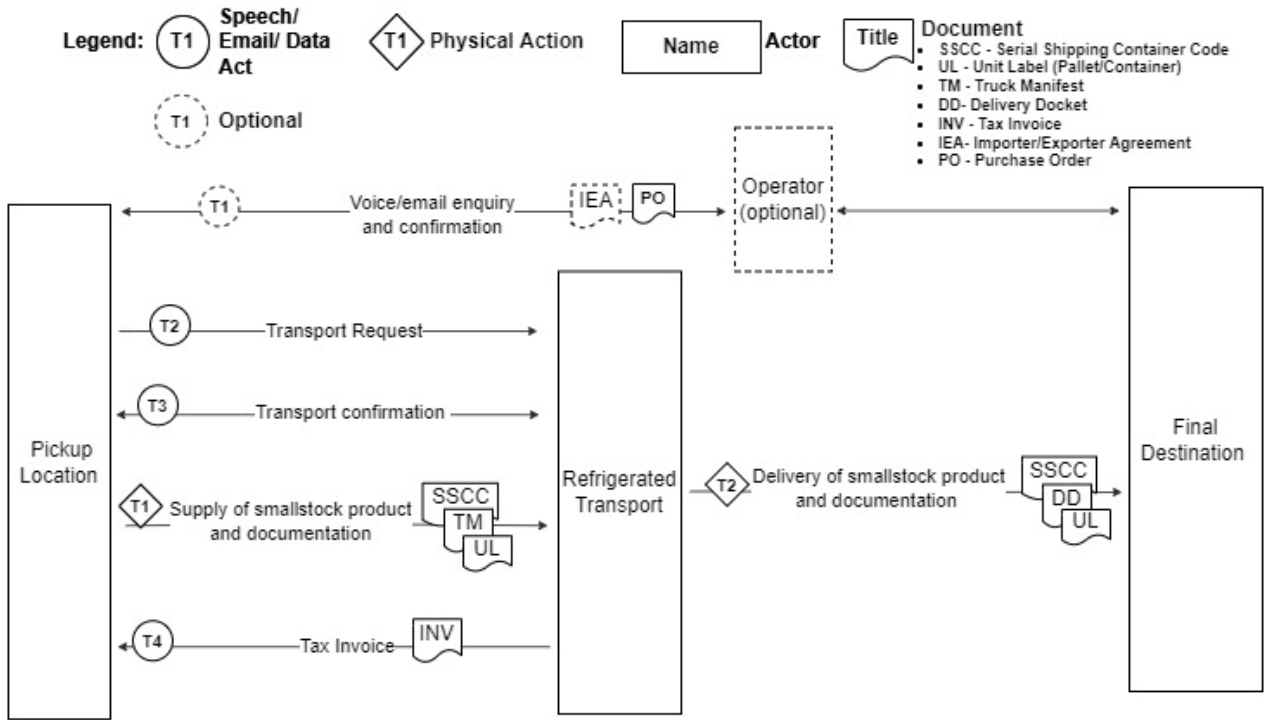

Import Refrigerated Transport

Figure 175. Data or information flows for the import refrigerated transport in the small stock supply chain.

5.2.7.3 Import bulk transport

Bulk transport involves the movement (including loading and unloading) of by-products (from render) or hides/skins from one premises to another. By-products and skins are typically manufactured into leather products, feed, fertilizer, and pharmaceutical products for commercial distribution. All bulk transport movements must be accompanied by Critical Tracking Event related documents such as delivery dockets and specific product movement documents.

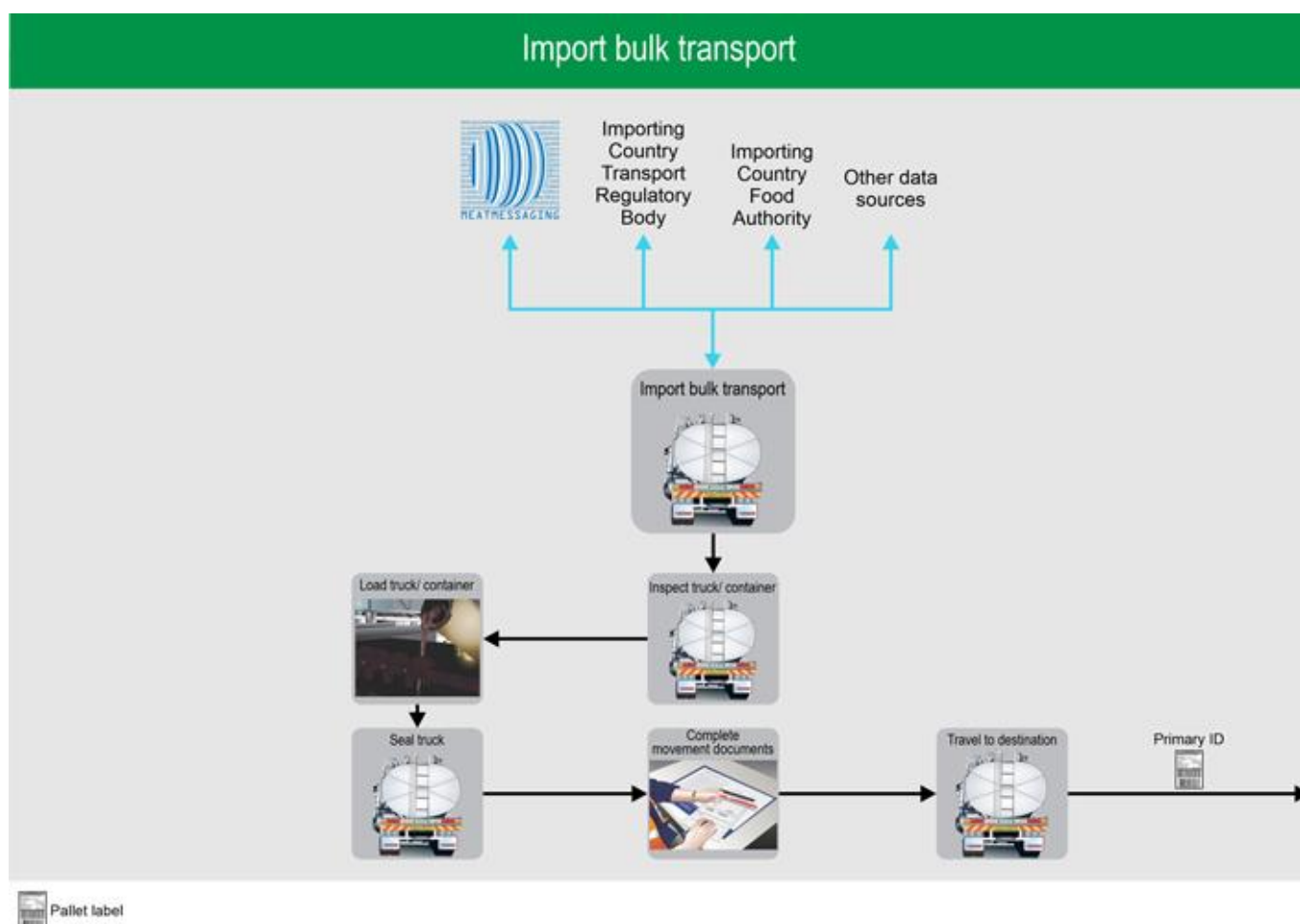

Figure 176. Inputs and outputs of the small stock supply chain import bulk transport sector.

5.2.7.3.1 Physical Inputs including Critical Tracking Events (CTEs)

Physical inputs into the import bulk transport system may include animal by-products from rendering or hide/skin processing facilities packaged into container system units. Documentation required to accompany the importation and transportation of such product includes the Bill of lading/Air Waybill, Certificate of Analysis (COA), Delivery docket and import specific meat/meat product movement forms among others.

Critical Tracking Events (CTEs) are defined as those events which include the growing, receiving, transforming, creating, and shipping of food products. Such events are critical to the traceability of product throughout the supply chain.

The CTEs associated with inputs to the import bulk transport system include the receipt of:

- Container System Unit (render and hide product).

Table 164. Physical inputs and associated Critical Tracking Event related documents for a small stock import bulk transport system.

Event related to the inputs	Description of the inputs	Critical Tracking Event (CTE) related documents (including electronic)	More details
Container System Unit (render and	A container designed for use as a unit of cargo handling equipment in the	Bill of lading/Air Waybill, Certificate of Analysis (COA), Delivery Docket/Manifest, Import Permit, Import specific meat/meat product movement forms, Import	

hide product)	transport of goods by aircraft or ship.	clearance documentation, Import Receipt of purchase/Tax Invoice	
---------------	---	---	--

5.2.7.3.2 Information Inputs including Key Data Elements (KDEs)

Key Data Elements (KDEs) are defined as those elements which are key in identifying and tracing the Critical Tracking Event (CTE). The transport of product between establishments is a Critical Tracking Event. Therefore, the KDEs here can largely be found on transportation documentation such as the Bill of lading/Air Waybill, import specific meat/meat product movement forms, Import clearance documentation and Certificate of Analysis. Other documentation such as Receipts of purchase/Tax Invoices will also contain KDEs.

Table 165. Information inputs, Key Data Elements and Critical Tracking Event related documentation for a small stock import bulk transport system.

Attributes (including KDEs)	Description of the Attributes (including KDEs)	Is a KDE	Critical Tracking Event (CTE) related documents (including electronic)	More details
Analysis Date	This is the date on which a product sample was analysed.	Yes	Certificate of Analysis (COA)	
Bill of lading/Air Waybill document number	A unique document number issued for traceability purposes.	Yes	Bill of lading/Air Waybill, Certificate of Analysis (COA)	
Certificate of Analysis number	A unique certificate number issued for traceability purposes.	Yes	Certificate of Analysis (COA)	
COA test lot identifier	This is a unique identifier allocated to all cartons, pallets, and shipping containers for which an analysis sample represents.	Yes	Certificate of Analysis (COA)	
Company/product code	This is an in-house code for the identification of the product in the unit.	Yes	Bill of lading/Air Waybill, Certificate of Analysis (COA), Import Receipt of purchase/Tax Invoice	
Consignment Serial Shipping Container Code (SSCC)	Encoded in the GS1 barcode, this is a unique number which identifies the individual logistic unit i.e., shipment/message that is assigned by the establishment constructing the unit. The SSCC remains the same for the life of the logistic unit.	Yes	Bill of lading/Air Waybill, Import clearance documentation	For more information visit the GS1 website.
Contract number	This is a unique number allocated to the contract by the seller.	Yes	Delivery Docket/Manifest	
Count of Trade Items	Usually encoded in the GS1 barcode, this is the number of trade items e.g., cartons in the logistic unit.	Yes	Bill of lading/Air Waybill, Delivery Docket/Manifest	For more information visit the GS1 website.
Date	This is the date of signing or of which a record entry or transaction was made.	Yes	Bill of lading/Air Waybill, Certificate of Analysis (COA), Delivery Docket/Manifest, Import clearance documentation, Import	

			Receipt of purchase/Tax Invoice	
Delivery Docket/Manifest number	This is a unique number allocated to the docket for identification purposes.	Yes	Delivery Docket/Manifest	
From Establishment number	A number issued by Federal and State Authorities to identify the originating site from which meat or meat products were distributed to domestic or export markets. For transfer certificates, the Establishment numbers for both the dispatching and receiving establishments are recorded.	Yes	Certificate of Analysis (COA), Delivery Docket/Manifest Import clearance documentation	
Import Permit Number	A unique permit number is allocated for the import consignment following submission of correct and validated documentation approved by the importing country.	Yes	Import Permit	
Movement date	The date on which livestock or other products (e.g., feed or meat products) were transported between PICs/establishments.	Yes	Bill of lading/Air Waybill, Certificate of Analysis (COA), Delivery Docket/Manifest, Import clearance documentation	
Net Weight (Kilograms)	Usually encoded in the GS1 barcode, the Net Weight is a variable measure of the trade item e.g., carton, pallet or shipment recorded in kilograms.	Yes	Bill of lading/Air Waybill	For more information visit the GS1 website.
NLIS Tag Number/RFID	All animals transported between PICs must have a permanent National Livestock Identification System tag attached. This tag has a unique animal identification number.	Yes	Bill of lading/Air Waybill	
Order date	This is the date on which the purchase order or contract was raised by the buyer.	Yes	Delivery Docket/Manifest	
Packaging Date	Encoded in the GS1 barcode, the Packaging Date is the date on which the item was packaged and is recorded in the format year, month, day (YYMMDD).	Yes	Certificate of Analysis (COA)	For more information visit the GS1 website.
Packaging Date Range	This includes the oldest and newest packaging dates for the logistic unit.	Yes	Import clearance documentation	
Pallet Serial Shipping Container Code (SSCC)	Encoded in the GS1 barcode, this is a unique number which identifies the individual logistic unit i.e., pallet that is assigned by the establishment constructing the unit. The SSCC remains the same for the life of the logistic unit.	Yes	Import clearance documentation	For more information visit the GS1 website.
Production Date (YYMMDD)	Encoded in the GS1 barcode, this is the 'kill' or slaughter' date of the product and is recorded in the format year, month, day (YYMMDD).	Yes	Certificate of Analysis (COA)	For more information visit the GS1 website.

Recipient Business Number	This is a unique registration number, used to identify businesses.	Yes	Import Receipt of purchase/Tax Invoice	
Seal Serial Number	This is a unique serial number printed on any tamper-evident seal issued by the Department.	Yes	Bill of lading/Air Waybill, Import clearance documentation	For more information visit the Australian Government Federal Register of Legislation.
Seller/Supplier Business Number	This is a unique registration number, used to identify businesses.	Yes	Import Receipt of purchase/Tax Invoice	
Shipping Mark	Also known as a port mark, this is a code comprising of three letters representing the foreign establishment number and the last nine digits of the consignment SSCC.	Yes	Bill of lading/Air Waybill, Certificate of Analysis (COA), Delivery Docket/Manifest	
To Establishment number	A number issued by Federal and State Authorities to identify the originating site from which meat or meat products were distributed to domestic or export markets. For transfer certificates, the Establishment numbers for both the dispatching and receiving establishments are recorded.	Yes	Import clearance documentation	
Trade description	This is a collective set of words that says what the product is and may include information such as species, net weight of product, name and address of establishments, category ciphers, market endorsements, MSA eating quality etc.	Yes	Delivery Docket/Manifest, Import clearance documentation	
Transport registration number	The registration number of the vehicle in which the animals or product were transported. For shipments of product this will be a shipping container number.	Yes	Bill of lading/Air Waybill, Delivery Docket/Manifest, Import clearance documentation	

5.2.7.3.3 Physical Outputs including Critical Tracking Events (CTEs)

Physical outputs of the import bulk transport system includes product (animal by-products from rendering or hide/skin processing facilities) which has been received in shipping containers from exporters. Documentation required to accompany the importation and transportation of such product includes the Bill of lading/Air Waybill, Certificate of Analysis (COA), Delivery docket and import specific meat/meat product movement forms among others.

Critical Tracking Events (CTEs) are defined as those events which include the growing, receiving, transforming, creating, and shipping of food products. Such events are critical to the traceability of product throughout the supply chain.

The CTEs associated with the outputs of the import bulk transport system include the movement of:

- Container System Unit (render and hide product) off the property, premises, or supply chain sector.

off the property, premises, or supply chain sector.

Table 166. Physical outputs and associated Critical Tracking Event related documents for a small stock import bulk transport system.

Event related to the inputs	Description of the inputs	Critical Tracking Event (CTE) related documents (including electronic)	More details
Container System Unit (render and hide product)	A container designed for use as a unit of cargo handling equipment in the transport of goods by aircraft or ship.	Bill of lading/Air Waybill, Certificate of Analysis (COA), Delivery Docket/Manifest, Import Permit, Import specific meat/meat product movement forms, Import clearance documentation, Import Receipt of purchase/Tax Invoice	

5.2.7.3.4 Information Outputs including Key Data Elements (KDEs)

Key Data Elements (KDEs) are defined as those elements which are key in identifying and tracing the Critical Tracking Event (CTE). The transport of product between establishments is a Critical Tracking Event. Therefore, the KDEs here can largely be found on transportation documentation such as the Bill of lading/Air Waybill, import specific meat/meat product movement forms, Import clearance documentation and Certificate of Analysis. Other documentation such as Receipts of purchase/Tax Invoices will also contain KDEs.

Table 167. Information outputs, Key Data Elements and Critical Tracking Event related documentation for a small stock import bulk transport system.

Attributes (including KDEs)	Description of the Attributes (including KDEs)	Is a KDE	Critical Tracking Event (CTE) related documents (including electronic)	More details
Analysis Date	This is the date on which a product sample was analysed.	Yes	Certificate of Analysis (COA)	
Bill of lading/Air Waybill document number	A unique document number issued for traceability purposes.	Yes	Bill of lading/Air Waybill, Certificate of Analysis (COA)	
Certificate of Analysis number	A unique certificate number issued for traceability purposes.	Yes	Certificate of Analysis (COA)	
COA test lot identifier	This is a unique identifier allocated to all cartons, pallets, and shipping containers for which an analysis sample represents.	Yes	Certificate of Analysis (COA)	
Company/product code	This is an in-house code for the identification of the product in the unit.	Yes	Bill of lading/Air Waybill, Certificate of Analysis (COA), Import Receipt of purchase/Tax Invoice	
Consignment Serial Shipping Container Code (SSCC)	Encoded in the GS1 barcode, this is a unique number which identifies the individual logistic unit i.e., shipment/message that is assigned by the establishment constructing the unit. The SSCC remains the same for the life of the logistic unit.	Yes	Bill of lading/Air Waybill, Import clearance documentation	For more information visit the GS1 website.
Contract number	This is a unique number allocated to the contract by the seller.	Yes	Delivery Docket/Manifest	
Count of Trade Items	Usually encoded in the GS1 barcode, this is the number of trade items e.g., cartons in the logistic unit.	Yes	Bill of lading/Air Waybill, Delivery Docket/Manifest	For more information

				visit the GS1 website.
Date	This is the date of signing or of which a record entry or transaction was made.	Yes	Bill of lading/Air Waybill, Certificate of Analysis (COA), Delivery Docket/Manifest, Import clearance documentation, Import Receipt of purchase/Tax Invoice	
Delivery Docket/Manifest number	This is a unique number allocated to the docket for identification purposes.	Yes	Delivery Docket/Manifest	
From Establishment number	A number issued by Federal and State Authorities to identify the originating site from which meat or meat products were distributed to domestic or export markets. For transfer certificates, the Establishment numbers for both the dispatching and receiving establishments are recorded.	Yes	Certificate of Analysis (COA), Delivery Docket/Manifest, Import clearance documentation	
Import Permit Number	A unique permit number is allocated for the import consignment following submission of correct and validated documentation approved by the importing country.	Yes	Import Permit	
Movement date	The date on which livestock or other products (e.g., feed or meat products) were transported between PICs/establishments.	Yes	Bill of lading/Air Waybill, Certificate of Analysis (COA), Delivery Docket/Manifest, Import clearance documentation	
Net Weight (Kilograms)	Usually encoded in the GS1 barcode, the Net Weight is a variable measure of the trade item e.g., carton, pallet or shipment recorded in kilograms.	Yes	Bill of lading/Air Waybill	For more information visit the GS1 website.
NLIS Tag Number/RFID	All animals transported between PICs must have a permanent National Livestock Identification System tag attached. This tag has a unique animal identification number.	Yes	Bill of lading/Air Waybill	
Order date	This is the date on which the purchase order or contract was raised by the buyer.	Yes	Delivery Docket/Manifest	
Packaging Date	Encoded in the GS1 barcode, the Packaging Date is the date on which the item was packaged and is recorded in the format year, month, day (YYMMDD).	Yes	Certificate of Analysis (COA)	For more information visit the GS1 website.
Packaging Date Range	This includes the oldest and newest packaging dates for the logistic unit.	Yes	Import clearance documentation	For more information visit the GS1 website.

Pallet Serial Shipping Container Code (SSCC)	Encoded in the GS1 barcode, this is a unique number which identifies the individual logistic unit i.e., pallet that is assigned by the establishment constructing the unit. The SSCC remains the same for the life of the logistic unit.	Yes	Import clearance documentation	For more information visit the GS1 website.
Production Date (YYMMDD)	Encoded in the GS1 barcode, this is the 'kill' or slaughter' date of the product and is recorded in the format year, month, day (YYMMDD).	Yes	Certificate of Analysis (COA)	
Recipient Business Number	This is a unique registration number, used to identify businesses.	Yes	Import Receipt of purchase/Tax Invoice	
Seal Serial Number	This is a unique serial number printed on any tamper-evident seal issued by the Department.	Yes	Bill of lading/Air Waybill, Import clearance documentation	For more information visit the Australian Government Federal Register of Legislation.
Seller/Supplier Business Number	This is a unique registration number, used to identify businesses.	Yes	Import Receipt of purchase/Tax Invoice	
Shipping Mark	Also known as a port mark, this is a code comprising of three letters representing the foreign establishment number and the last nine digits of the consignment SSCC.	Yes	Bill of lading/Air Waybill, Certificate of Analysis (COA), Delivery Docket/Manifest	
To Establishment number	A number issued by Federal and State Authorities to identify the originating site from which meat or meat products were distributed to domestic or export markets. For transfer certificates, the Establishment numbers for both the dispatching and receiving establishments are recorded.	Yes	Import clearance documentation	
Trade description	This is a collective set of words that says what the product is and may include information such as species, net weight of product, name and address of establishments, category ciphers, market endorsements, MSA eating quality etc.	Yes	Delivery Docket/Manifest, Import clearance documentation	
Transport registration number	The registration number of the vehicle in which the animals or product were transported. For shipments of product this will be a shipping container number.	Yes	Bill of lading/Air Waybill, Delivery Docket/Manifest, Import clearance documentation	

5.2.7.3.5 Regulatory and Industry Programs

- Importing Country Transport Regulatory Body
- Importing Country Food Authority
- Meat Messaging
- Other data sources

5.2.7.3.6 Supply Chain Node Traceability

The traceability of imported rendered and skin product, that is bulk transported, back to the live animal, or consignment group and property of origin is operationally impractical. This is because rendered and hide products are bulk processed and packaged from any given processing day or number of processing days. While this means that the production date or kill date of animals from which skins or rendered product is likely to be known, any batch of product being packaged into store bags or pallets with unique serialised labels is only traceable to any number of source properties.

For example, skins or product for render which make up one batch may come from a total of 6 plant kill day combinations. For each processing day 4 000 animals, sourced from 10 different properties are slaughtered and the unique serialised NLIS ID tag numbers, or PICs known for each animal as well as that of the corresponding carcase ticket. With render or skin products from these processing days being processed and packaged in one batch, the unique serialised identifiers of output products can be linked only to that batch and the processing dates from which product was obtained. This means that one batch is comprised of any of 24 000 source animals that were supplied by a maximum of any of 60 potential source properties.

Traceability requirements post slaughter differ depending on the importing country. Typically, bulk transported product will be accompanied by import specific meat/meat product movement forms and a Meat Messaging Consignment Report. The Consignment Report is issued to the buyer of product and lists all the logistic unit and subunit unique serialised identifiers contained within the Container System Unit to be exported including the Consignment Serial Shipping Container Code (SSCC), Pallet Serial Shipping Container Code, and scanned and verified carton label serial identifiers. Additionally, the product movement forms detail the serialised logistic unit identifiers such as the Serial Shipping Container Code (SSCC). These documents allow traceability of the unit and its subunits back to any number of source properties.

5.2.7.3.7 Data flow diagrams

Table 168. Data flow diagrams for the inputs and outputs of a small stock import bulk transport.

Direction	Description
Input	Import Bulk Transport Render

5.2.7.3.7.1 Import Bulk Transport Render

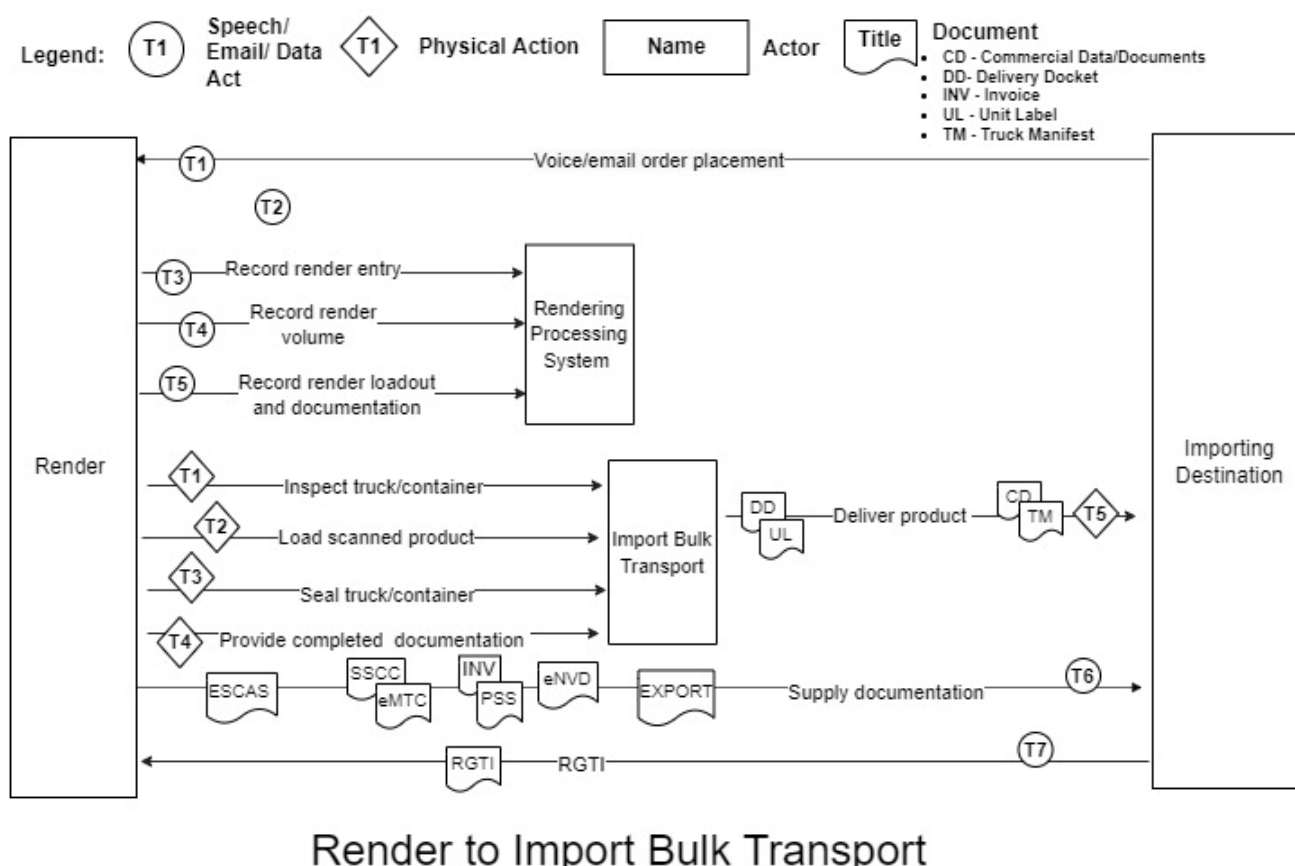

Figure 177. Data or information flows from render to import bulk transport in the small stock supply chain.

6 Glossary

Term	Abbreviation	Description	Beef	Sheep	Dairy
National Vendor Declaration	NVD	A document issued by a vendor to certify the origin of the vendor and its livestock.	X	X	X
Meat Standards Australia	MSA	A standards organisation that sets and defines criteria for assessing red meat quality.	X	X	
National Vendor Declaration	eNVD	An electronic document issued by a vendor to certify the origin of the vendor and its livestock.	X	X	X
Recipient Generated Tax Invoice	RGTI	Tax invoice supplied by the vendor or supplier.	X	X	X
Commercial Data	CD	Multiple documents provided e.g., Commercial supply contract, reporting analysis health certificate etc.	X	X	X

Producer feedback	PF	Producer feedback provides insights on how well a carcass performed e.g., MSA grading	X	X	X
National Feedlot Accreditation Scheme	NFAS	Independently audited quality assurance program for the Australian lot feeding industry.	X	X	
Slaughter feedback	SF	Providing feedback to producers or vendors on carcass performance.	X	X	X
Slaughter details	SD	Information and data associated to slaughter.	X	X	
Post-Sale Summary	PSS	A series of tasks that you perform after a customer purchases a product or service.	X	X	X
Kill agenda	KA	An agenda of animals slaughtered on a production day at a processing establishment,	X	X	
Carcass Ticket	CT	A ticket or tag applied to a carcass usually on the slaughter floor and scanned at boning room entry, carcass load in or load out. Provides traceability of the carcass as it moves throughout the processing establishment.	X	X	
Production plan	PP	A production plan is a step-by-step plan implemented at the start of the production day to provide efficient processing of the production life cycle.	X	X	
Pallet label	PL	It is a label applied to a pallet of production after palletisation and shrink wrapping. It is necessary to have correct labelling for logistics, traceability and distribution process.	X	X	X
Unit Label	UL	A label applied to an object or product to describe what it is.	X	X	
Serial Shipping Container Code	SSCC	An 18-digit number used to identify product. SSC is encoded in the barcode and can also be encoded in an RFID tag.	X	X	X
Tender Document	TD	A document outlining a formal statement of the tender participants offer to supply product.	X	X	
Picking instruction	PI	A process of picking items and product from the warehouse inventory.	X	X	X
Truck Manifest	TM	A truck manifest is a document outlining the pickup and drop off associated with the booking or order. It is assigned to a specific truck and assists traceability measures for product being loaded out or loaded in.	X	X	X

Stock on Hand	SOH	Stock on hand is the amount of product that a processing establishment or warehouse has available at a particular time.	X	X	X
Storage Detail	SD	Details on what and where product is located at a processing establishment, warehouse or cold store facility.	X	X	X
Delivery Docket	DD	A delivery is a document accompanying product being delivered to a particular location.	X	X	X
Invoice	INV	A receipt or proof of purchase or tax invoice.	X	X	X
Global Trade Item	GTIN	The Global Trade Item Number is an identifier for trade items developed by the international organisation GS1.	X	X	X
Export Permit	EXPORT	Issued by DAWE, it provides permission to conduct a specific export transaction.	X	X	X
Purchase Order	PO	A contract between the buyer and a seller which specifies information relating to the goods, delivery and terms and conditions of purchase	X	X	X
Production Order	PRO	An order issued within a company to produce a specific quantity of material within a certain timeframe.			X
Importer/Exporter Agreement	IEA	A contract between the importing and exporting businesses which specifies the terms of trade.			X
Export Health/Government Certificate	HC	A certificate issued by the Department containing details about the product being exported and confirming that certain importing country requirements have been met to facilitate clearance of goods at import. Depending on requirements, the certificate will be signed by either a Veterinary or Authorised Officer.	X	X	X
Import Permit	IP	A document that confirms eligibility of goods for import and facilitates the importation of these goods by a country.			X
Transfer Declaration	TD	A declaration statement made by the dispatching establishment regarding the export eligibility of the goods being moved.			X
Export Documents	ED	Covers all official export documents for transport and government requirements.			X
Logistics Management Records	LMR	Internal record keeping system, electronic or paper based.			X
Processor Management Records	PMR	Internal record keeping system, electronic or paper based.			X

Exporter Supply Chain Assurance System	ESCAS	The Exporter Supply Chain Assurance System is an assurance system based on commercial arrangements with supply chain partners in importing countries to provide humane treatment and handling of livestock.	X	X	
Export Documentation System	EXDOC	EXDOC is the DAWEs electronic export documentation system with the purpose of managing export documentation for primary produce.	X	X	X
Importing Country Government System	ICGS	A system used by Importing Country Government for inspection and verification of importing country requirements.	X	X	X
Importing Country Food Authority	ICFA	Importing Country Food Authority implement certain requirements for commercially viable product. e.g., Import Supermarket	X	X	X
Import Specific livestock movement forms	ISF	Import specific commodity movement forms and livestock movement forms. This includes the property (PIC) from/to where the livestock or product were consigned	X	X	

7 Reference List

- EUR-Lex. (2002). Regulation (EC) No 178/2002 of the European Parliament and of the Council of 28 January 2002 laying down the general principles and requirements of food law, establishing the European Food Safety Authority and laying down procedures in matters of food safety. Retrieved from <https://eur-lex.europa.eu/legal-content/EN/TXT/?uri=CELEX%3A32002R0178>
- Food Standards Australia & New Zealand. (2021). Food traceability Retrieved from <https://www.foodstandards.gov.au/industry/safetystandards/traceability/pages/default.aspx>
- GS1US. (2014). A Model for the Adoption of Critical Tracking Events (CTEs) in the Meat & Poultry Supply Chain. In. The Traceability Working Group. (2019). *National Traceability Framework: enhancing Australia's world-class agricultural traceability systems*. Canberra: CC BY 4.0
- Zhang, J., & Bhatt, T. (2014). A Guidance Document on the Best Practices in Food Traceability. *Comprehensive Reviews in Food Science and Food Safety*, 13(5), 1074-1103. doi:10.1111/1541-4337.12103